

USE AND MAINTENANCE INSTRUCTIONS MANUAL FOR DOSING PUMP



HC151+ pH(Rx)-CI(J) HC200+ pH(Rx)





FILTRATION - DOSING - DETERGENT & HYGIENE - POOL EQUIPMENT



DECLARATION OF CONFORMITY

Company:	AQUA S.p.A.
Address:	Via T. Crotti, 1 - 42018 - San Martino in Rio (RE)

Hereby declares that the products named:

- **HC151+ pH(RX)**
- **HC151+ Cl(J)**
- **HC200+ pH(RX)**

Responds to the principal features of the following European Directives:

- **2014/30/CE of 26/02/2014** - *Harmonization of the laws of the Member States relating to electromagnetic compatibility – EMC Directive*
- **2014/35/CE of 26/02/2014** - *Harmonization of the laws of the Member States relating to the making available on the market of electrical equipment designed for use within certain voltage limits – Low Voltage Directive*
- **2011/65/UE of 08/06/2011 with subsequent update 2015/863 of 31/03/2015** - *ROHS III Directives*
- **2012/19/UE of 04/07/2012** - *WEEE Directives for electrical and electronic waste*

This declaration is issued under the responsibility of Aqua S.p.A.

San Martino in Rio (RE)
 Power of attorney
 Davide Vezzani - Aqua S.p.A.



INDEX

1. GENERAL RULES.....	4
1.1 SHIPPING AND TRANSPORTING THE PUMP	4
1.2 INSTALLATION STANDARDS	4
1.3 PROPER USE OF THE PUMP	4
2. OPERATION	6
2.1 OVERALL DIMENSIONS.....	6
2.2 TECHNICAL FEATURES.....	6
2.3 HYDRAULIC FEATURES	7
2.4 PERFORMANCE GRAPHS.....	8
2.5 CONTENT OF THE PACKAGE (Standard version)	9
3. HC151+ pH(Rx)-Cl(J) / HC200+ pH(Rx)	10
3.1 HC151+ /HC200+ PUMP CONTROLS.....	10
3.2 FIRST PUMP INITIALIZATION.....	11
3.3 HOW TO NAVIGATE THROUGH THE MENUS.....	12
3.4 GETTING STARTED.....	13
3.4.1 Priming.....	13
3.4.2 Pump calibration	14
3.5 PUMP SETUP.....	15
3.5.1 SETPOINT menu	15
3.5.2 CALIBRATION menu	17
3.6 CORRELATION BETWEEN FREE CHLORINE, pH e REDOX	20
3.7 TIMER SETUP	21
3.8 SETTINGS	22
3.8.1 General e Security	22
3.8.2 General > Proximity sensor	23
3.8.3 Generals > Temperature probe	24
3.8.4 Generals > Measure startup delay.....	25
3.7.5 General > Energy saving	25
3.8.6 Security > Password	26
3.8.7 Security > Level Input Polarity	26
3.8.8 Security > Low Level Delay	27
3.8.9 Security > Inhibit input selection	28
3.8.10 Security > Over Feed Alarm (OFA).....	30
3.8.11 Security > Minimum / Maximum value alarm.....	30
3.8.12 Security > Factory Settings restore.....	31
3.9 STATISTICS.....	32
4. DOSING PUMPS INSTALLATION RULES.....	33
5. ELECTRICAL CONNECTIONS.....	34
5.1 HC151+ PlmA model pump	34
6. TROUBLESHOOTING.....	35
6.1 PROBLEM – CAUSE – SOLUTION.....	35
7. MAINTENANCE.....	35
7.1 CLEANING THE PUMP	35
7.2 PUMP MAINTENANCE.....	36
8. WARRANTY.....	36
EXPLODED VIEWS	37

1. GENERAL RULES

Carefully read the warnings listed below as they provide important information regarding the rules for installation, use and maintenance.

Please keep this manual carefully for further reference.

1.1 SHIPPING AND TRANSPORTING THE PUMP

The equipment must be transported in its original packaging, organized and built in such a way as to minimize shocks and to protect the protruding parts that can be damaged. If there is a need for transport after the equipment has already been installed (e.g. for a return for repair or replacement), reuse the original packaging or a sufficiently sturdy packaging with the equipment protected with absorbent material (eg bubble wrap). The external packaging must be such as to ensure the safety of the equipment in the event of a fall from 1 meter in height.

1.2 INSTALLATION STANDARDS

Install the dosing pump so that it is easily accessible whenever maintenance is required. Never obstruct the place where the dosing pump is located.

The servicing and maintenance of the dosing pump and all its accessories must always be carried out by qualified personnel.

AQUA SpA cannot be held responsible for damage to persons or things caused by poor installation or incorrect use of the dosing pump.



Check that the ground is fully functional and corresponds to the regulations in force. Make sure there is a high sensitivity differential switch (0.03 A). Check that the pump ratings are compatible with those of the mains supply. Never install the pump directly in parallel with inductive loads (eg motors / solenoid valves) but if necessary use an "insulation relay". Inside the pump there are two protections: a varistor and a fuse.

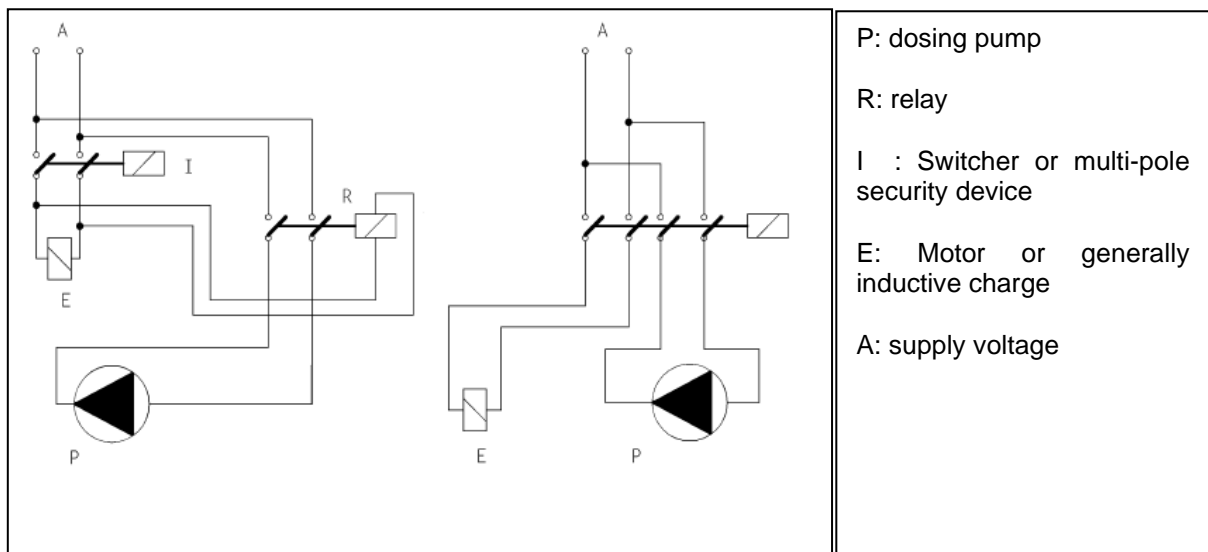

1.3 PROPER USE OF THE PUMP

The use of this pump must comply with the methods and instructions set out in this manual. The pump can dose chemicals that can be harmful to human health and for this reason it is essential that must be used by qualified personnel who adopt the appropriate safety methods and personal protective equipment.

AVOID IMPROPER USE of the equipment in order to avoid damage to things and people, due to uncontrolled splashes, drips, electrical contacts, etc.

The following uses can be considered improper uses, in indicative and non-exhaustive form:

- Dosing of products not consistent with the materials with which the pump is made;
- Dosing of explosive and / or flammable products;
- Dosing of fluids with excessive viscosity (1000 cps), such as to prevent the priming of the pump itself;
- Dosage of food liquids, if intended to maintain such use;
- Avoid inverting the pump delivery and suction;

- *Avoid powering the pump with voltages other than those indicated in the technical specifications;*
- *Avoid connecting any equipment other than specific equipment to the signal outputs (level, pulse counter, current signal, etc.);*

2. OPERATION

The HC151+ / HC200+ pH(Rx)-CL(J) digital pumps are solenoid dosing pumps with integrated measuring controller that can monitor and modify the chemical-physical parameters (such as pH, redox or chlorine) of the water to be treated. The pumps have two BNC connectors: one for pH or Redox electrode connection, the other for connecting a level sensor. For the connection of a Chlorine sensor, the pump is equipped with a 4-way connector. The pump is also designed to connect a PT100 temperature sensor and a proximity sensor (not included in the package) to monitor the temperature and the presence of flow inside an electrode holder.

2.1 OVERALL DIMENSIONS

HC151+

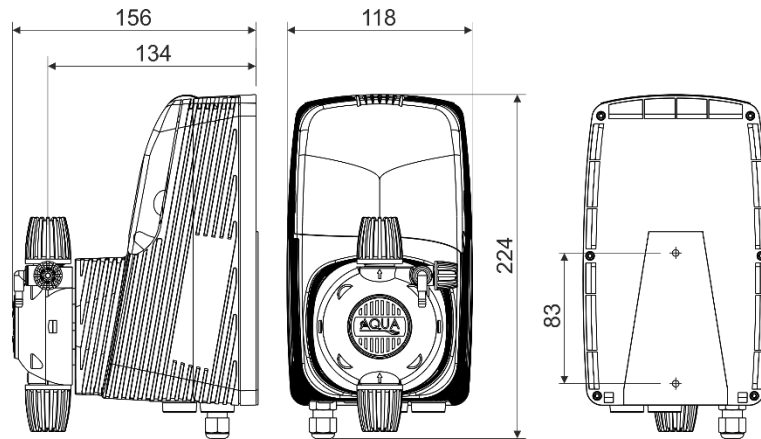

HC200+

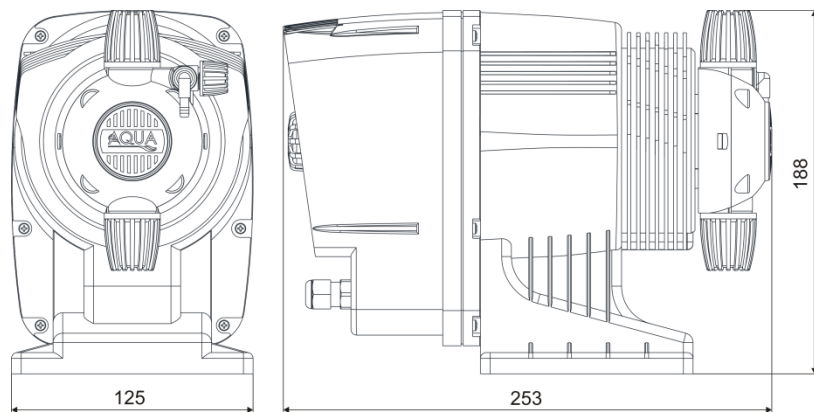

2.2 TECHNICAL FEATURES

Power supply:	100÷240VAC ± 10% – 50/60Hz
Insulation Class:	CLASS I
Absorbed power:	see "2.3 - Hydraulic Features"
Fusible:	2 A – RIT
Protection Grade:	IP65
Environmental conditions:	Closed environment, altitude up to 2000m, room temperature from 5°C up to 40°C, maximum relative humidity 80% (linearly decreases until it is reduced to 50% at 40°C).



THE EQUIPMENT, SUBJECT TO THIS DOCUMENT, ARE NOT INTENDED TO BE INSTALLED AND USED IN EXPLOSIVE ATMOSPHERE ENVIRONMENTS. IT ISN'T AN ATEX PUMP.

2.3 HYDRAULIC FEATURES

Hydraulic characteristics of the 230V version

SOLENOID	TYPE	FLOW RATE	PRESSURE	STROKES	INJECTION VALUE	ABSORBED POWER
		l/h	bar	spm	ml/stroke	Watt
60	A	1	7	100	0,17	13
		5	1		0,83	13
	B	3	7	150	0,33	16
		9	1		1	16
	C	5,5	6	180	0,51	22
		10	1		0,93	22
70	A	1,8	20	75	0,40	18
		4	1		0,89	18
	B	4	12	120	0,56	25
		7	1		0,97	25
	C	5,8	9	180	0,54	27
		14	1		1,30	27
80 (only HC151)	A	4	20	150	0,44	24
		10	1		1,11	24
	B	6,5	12	200	0,54	27
		13	1		1,08	27
	C	13,5	5	300	0,75	35
		20	1		1,11	35

The above data refer to tests carried out with water at room temperature.

Values can fluctuate by 10%.

Chemicals with viscosity different than water may also have significant variations on the flow rate.

Hydraulic characteristics of the 110V version

SOLENOID	TYPE	FLOW RATE	PRESSURE	STROKES	INJECTION VALUE	ABSORBED POWER
		l/h	bar	spm	ml/stroke	Watt
60	A	1,5	7	100	0,25	18
		5	1		0,83	18
	B	4,5	7	150	0,5	23
		7	1		0,78	23
	C	6	6	180	0,56	28
		8,8	1		0,81	28
70	A	1	20	75	0,22	21
		4,5	1		1	21
	B	4	12	120	0,56	31
		7	1		0,97	31
	C	6,8	9	180	0,63	41
		10,8	1		1	41
80 (only HC151)	A	3	17	150	0,33	27
		10	1		1,11	27
	B	7,5	12	200	0,63	36
		13	1		1,08	36
	C	11	5	230	0,80	44
		16	1		1,16	44

The above data refer to tests carried out with water at room temperature.

Values can fluctuate by 10%.

Chemicals with viscosity different than water may also have significant variations on the flow rate.

2.4 PERFORMANCE GRAPHS

2.4.1 graphs relating to the 230V versions

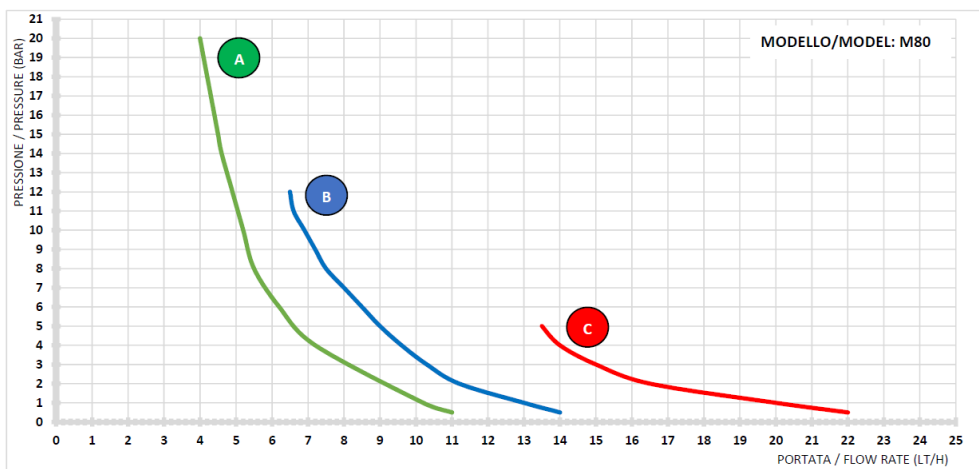
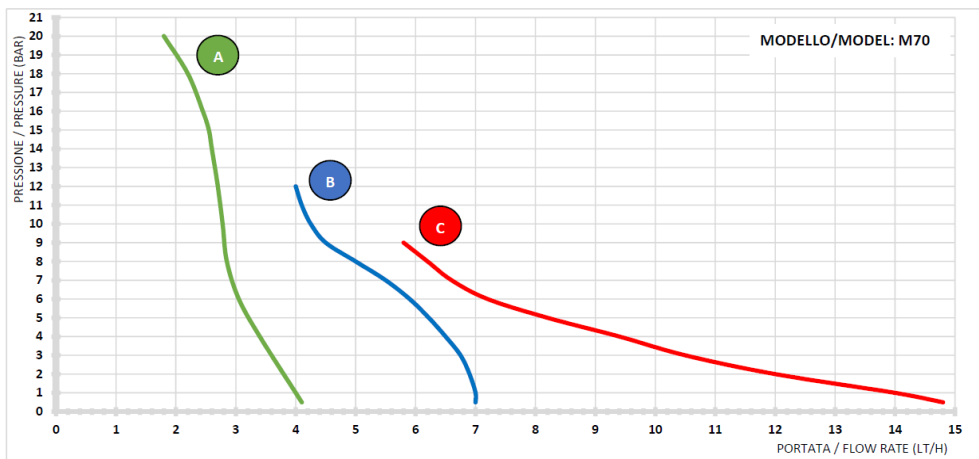
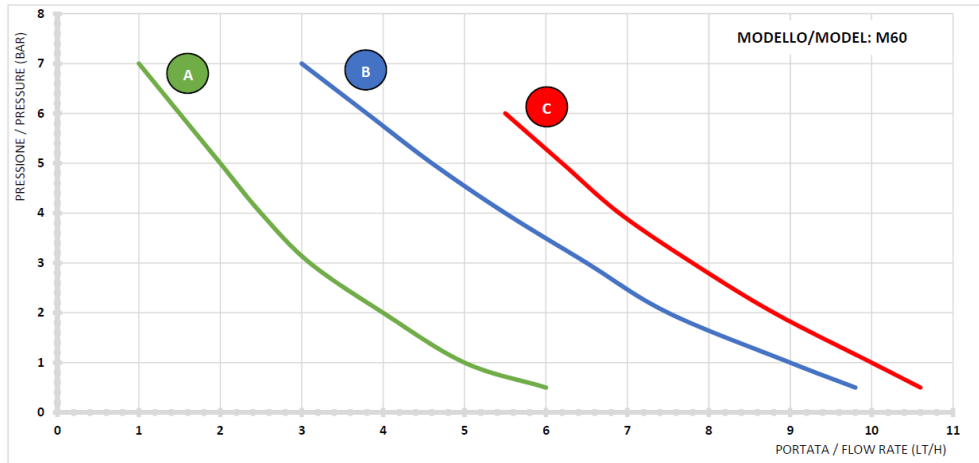

2.4.2 graphs relating to the 110V versions

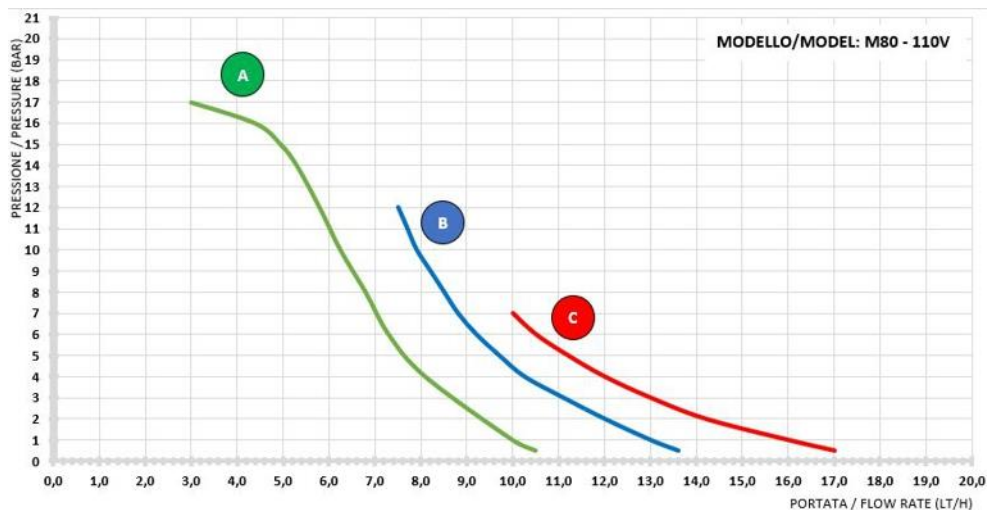
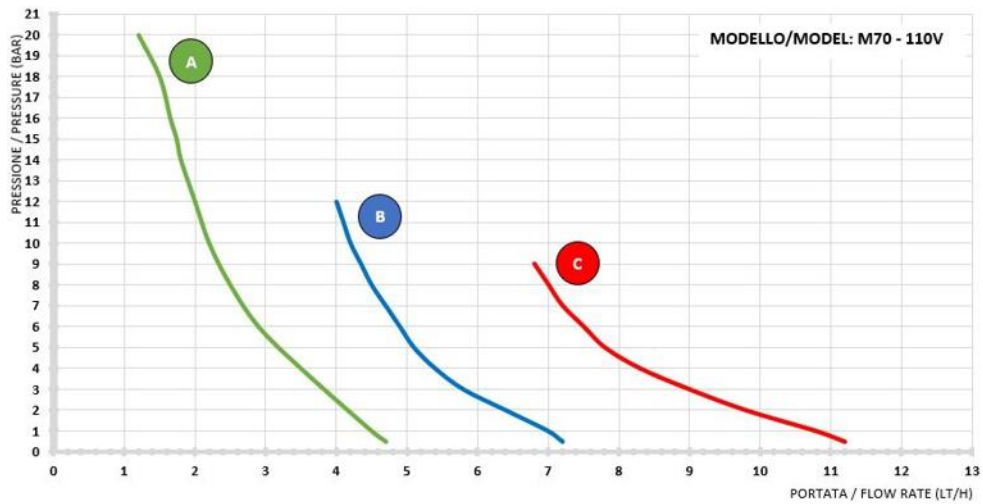
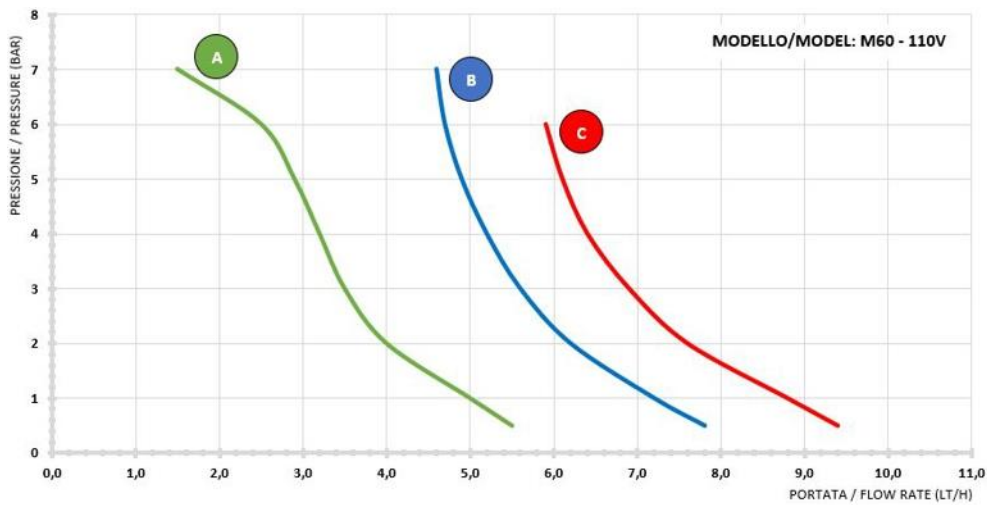

2.5 CONTENT OF THE PACKAGE (Standard version)

- HC151+ or HC200+ pump
- Quick Start Guide
- Injection valve PVDF-CE-VT
- Foot filter PVDF-PTFE-VT
- 2 meters PE discharge tube
- 2 meters PVC suction tube

- 2 meters PVC bleed valve tube (2 m)
- Fixing bracket (only for HC151+)
- Set of screws and plugs for wall mounting

3. HC151+ pH(Rx)-CI(J) / HC200+ pH(Rx)

3.1 HC151+ /HC200+ PUMP CONTROLS

The control panel of the HC151+ pH(Rx)-CI (J) and HC200+ pH(Rx) pump is composed of a graphic display (1) and an encoder knob (2) which allow you to navigate through the various menus and select / modify the parameters of the pump. The figures below, show what the control panel looks like:



A. Active function;

1. 132x56 pixel graphic display;
2. Encoder;
3. Mechanical stroke length adjustment (only for HC200+)

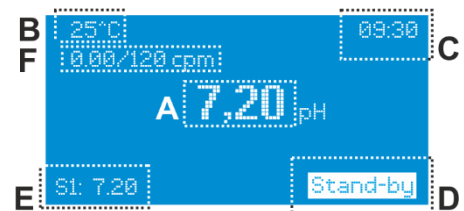

- B. Configured parameters;
- C. Time;
- D. Warnings messages
- E. Setpoint
- F. Partition pulse/minute

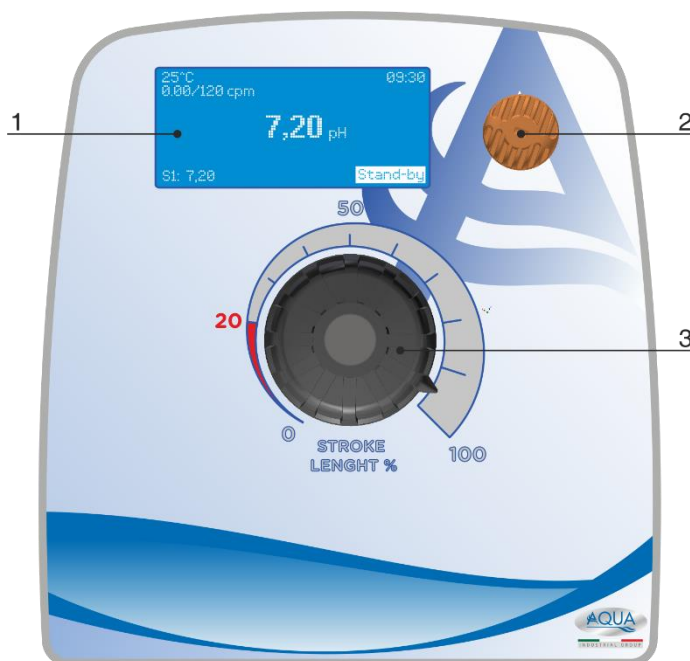

HC200+



Press to: confirm a value or access a submenu. If it is kept pressed for 2 seconds, it returns to the previous menu or activates / deactivates the Stand-by.

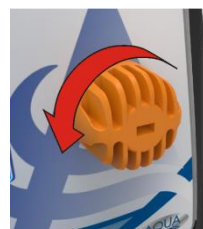

Turn to: navigate the menus or change a numeric value.

3.2 FIRST PUMP INITIALIZATION

The first time the pump is switched on, some basic parameters must be set, such as the language in which the programming menus will be displayed, the date and time of the system and other basic settings.

Below is a diagram of what appears when the unit is first turned on:

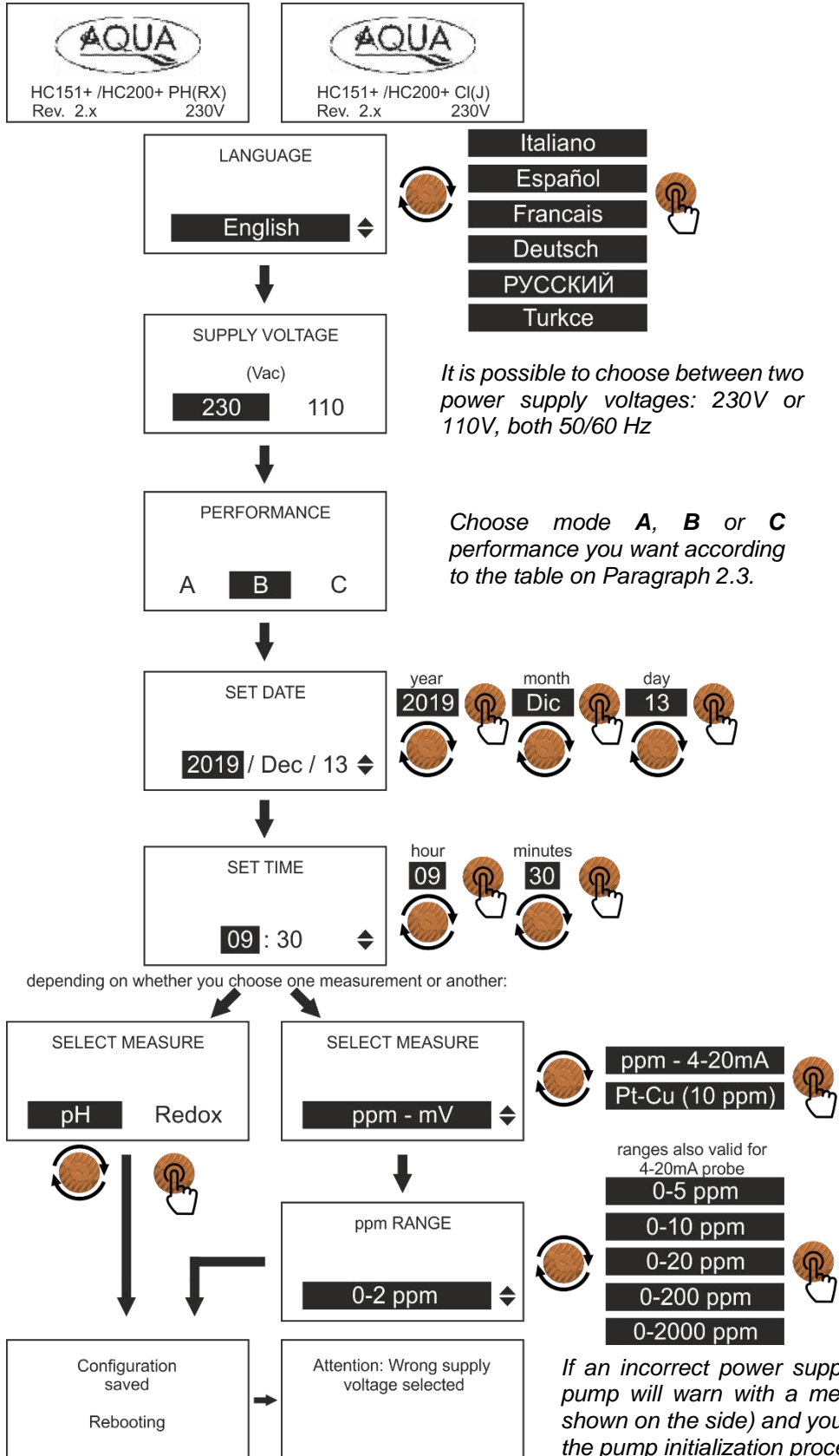

3.3 HOW TO NAVIGATE THROUGH THE MENUS

The pump has been designed so the programming phases are user friendly, for this purpose the control area has a large backlit graphic display and a rotary encoder with an integrated button function. A navigation diagram of the menus on the pump is shown below:

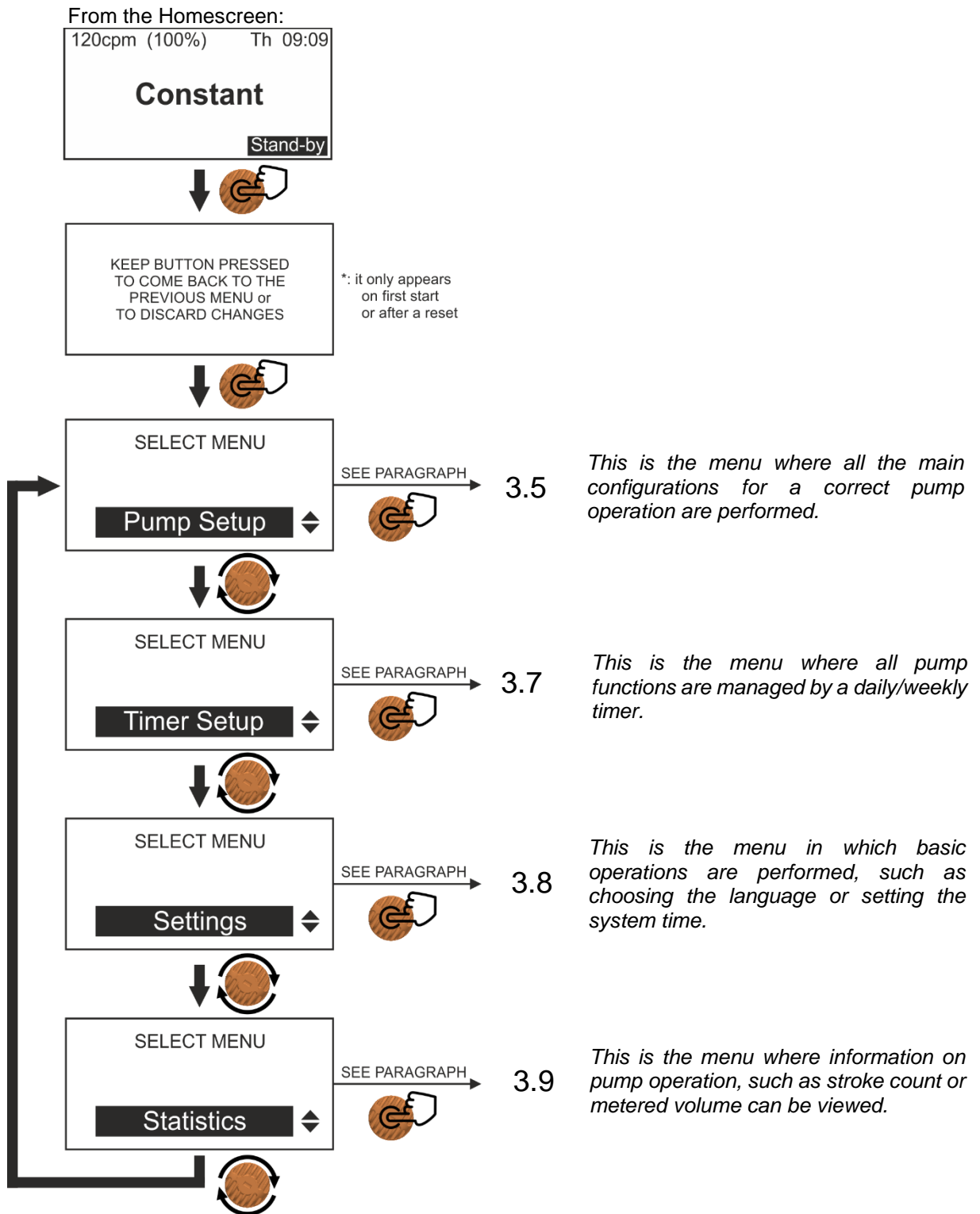

3.4 GETTING STARTED

3.4.1 Priming

Once the basic parameters of the pump have been set, it is suggested to carry out the priming: this operation is used to "prime" the metering pump (i.e. fill the chamber between the membrane and the pump body and remove any air bubbles present inside the suction and discharge tubes) and make it ready to dose the chemical in the plant.

Before proceeding with priming, make sure you have connected the delivery and suction tubes to the pump body as well as the air purge tube included in the supply (for the connection, follow the image shown below:

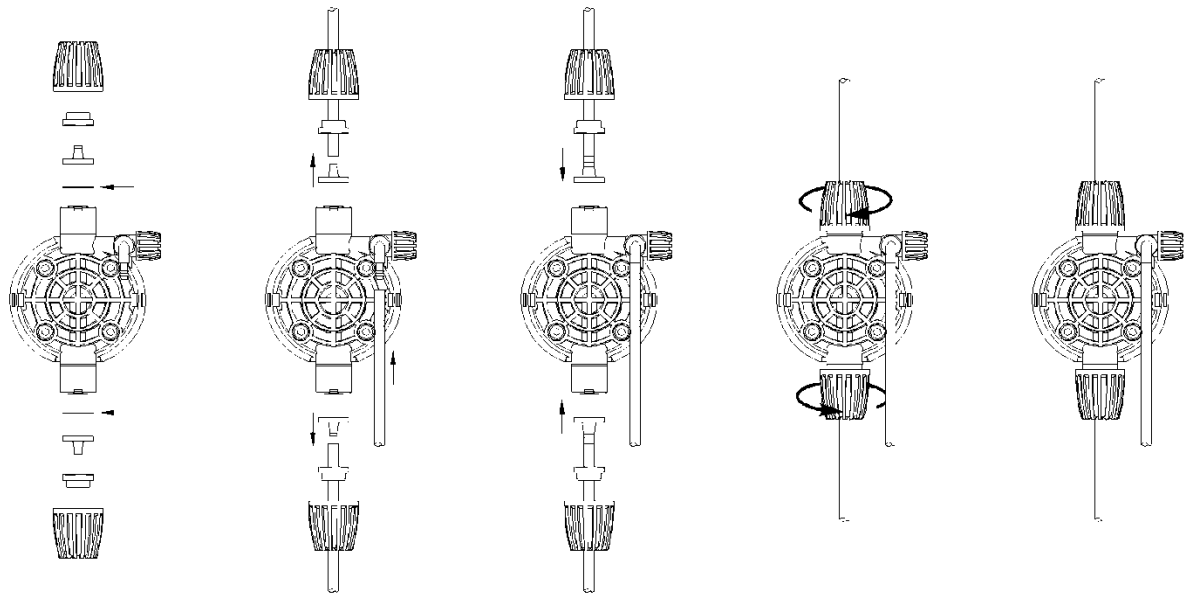

For priming, follow the steps below:

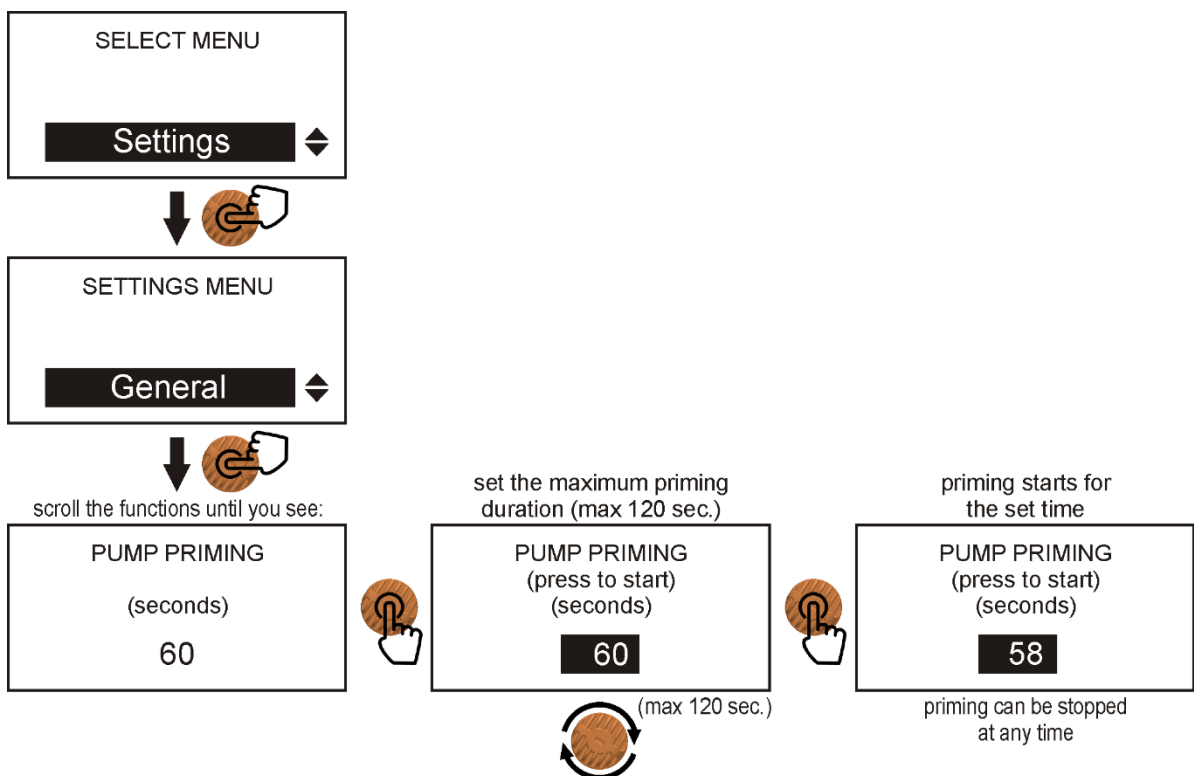

3.4.2 Pump calibration

Once the priming procedure is complete, the quantity of ml (milliliters) per stroke that the pump can supply must be defined, this information is necessary for a correct dosage of the chemical and essential if you want to use the PPM function described in the "PUMP SETUP" paragraph.

ATTENTION: in order to use this function, the pump MUST be primed.

To calibrate the pump, follow the steps below:

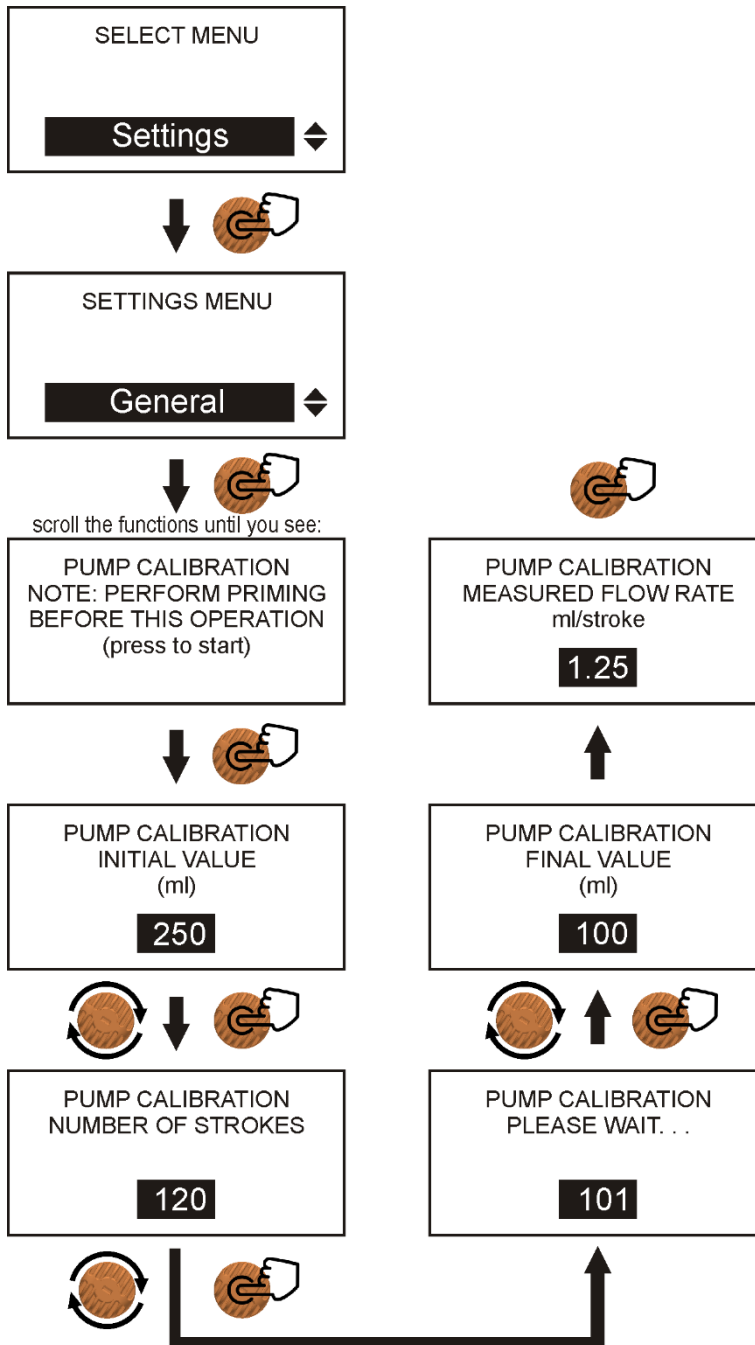

1. Make sure that the pump has been installed on the plant and it has been primed using the function described in the previous paragraph (§ 3.4.1)

2. Connect the suction tube (complete with foot filter) into a BEKER-type test tube graduated in ml (milliliters);

3. Fill the test tube until reaching the maximum limit with the chemical product that will be used during the normal operation of the pump;

4. Power up the pump, enter the **SETTINGS > GENERAL MENU**, follow the instructions on the display: enter the maximum value of the beker by turning the encoder knob, then press the knob to confirm;

5. Set the number of strokes the pump will perform;

6. Once the button has been pressed to confirm, the pump will start for the number of strokes set;

7. At the end, check how much chemical is left in the beker and write down this value on the display using the knob, finally press to confirm this value;

8. the next screen will show the value calculated by the pump in ml per stroke.

9. To exit the calibration function, keep the button pressed for 2 seconds.

3.5 PUMP SETUP

Within this menu, you can choose whether to set the working point (setpoint) or calibrate the probes connected to the pump.

The complete list of available functions is shown below:

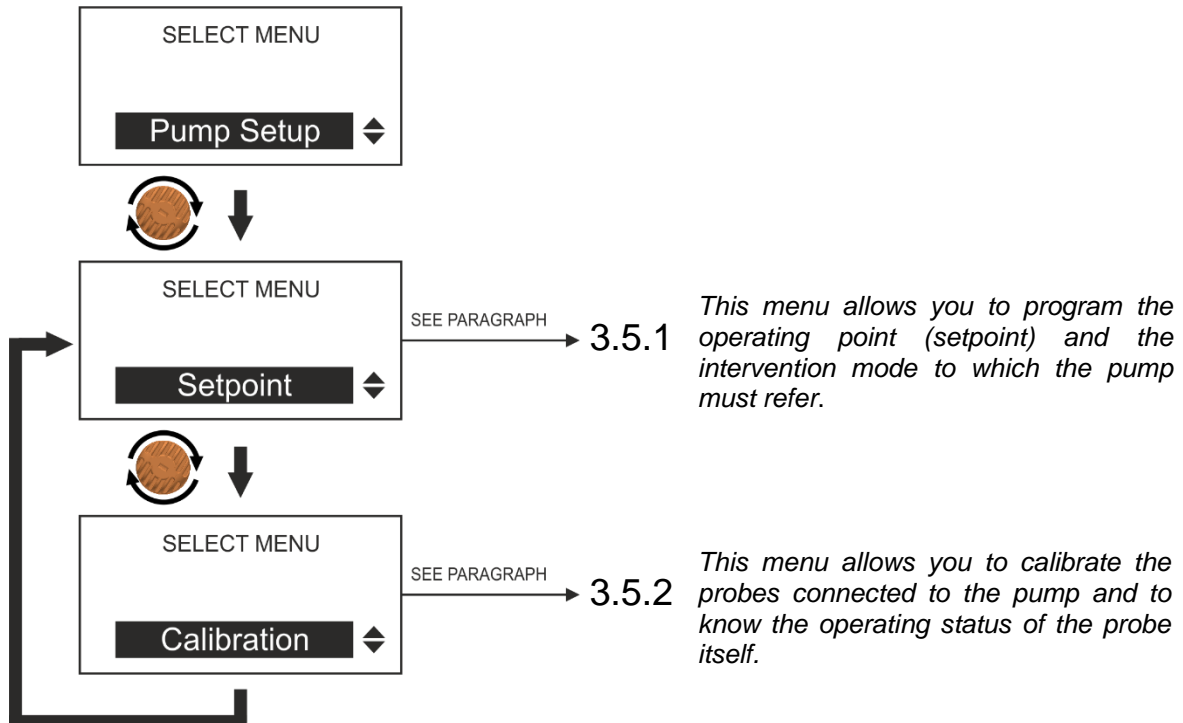

3.5.1 SETPOINT menu

This function allows you to program the working point (Setpoint) and to program the proportional dosage according to the value of the measurement read.

Here are the steps to set up this feature:

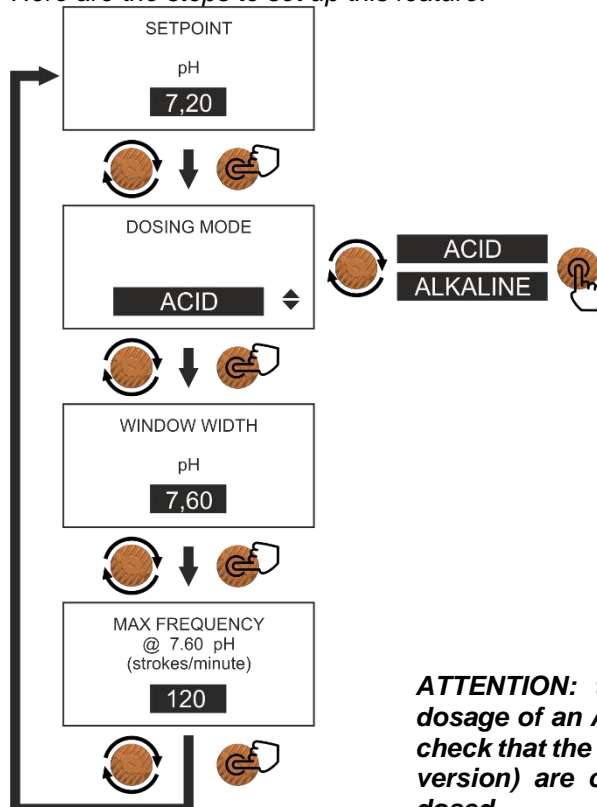

Eg pH: dosing of an **ACID** chemical:
 Setpoint: **7.20 pH**
 Window width limit: **7.60 pH** (e.g. 120 strokes / min);
 For values equal to or lower than the Setpoint, the pump is stopped;
 The pump works at maximum frequency for values equal to or greater than the set window width limit, the frequency decreases as the pH value decreases until it stops at the Setpoint.

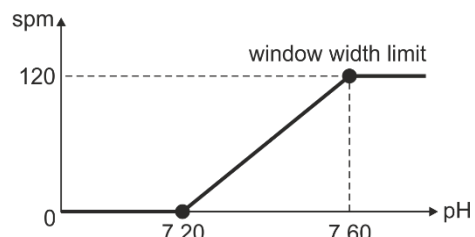

ATTENTION: the pump can also be programmed for the dosage of an Alkaline chemical product but it is necessary to check that the seals in the pump body (in Viton for the standard version) are chemically compatible with the product to be dosed.

Setpoint Redox:

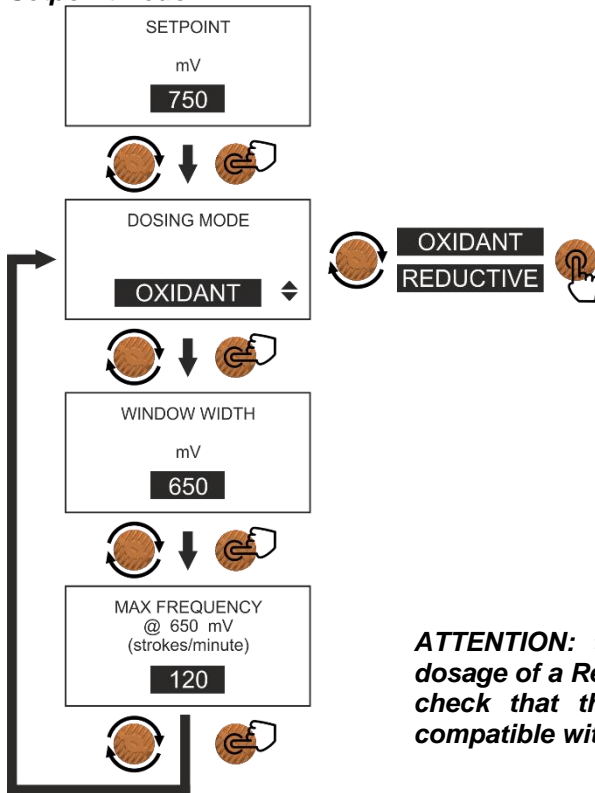

Es. Redox: dosing of an **OXIDANT** chemical:

Setpoint: **750 mV**

Window width limit: **650 mV** (es. 120 strokes/minute);

For values equal to or higher than the Setpoint, the pump is stopped; The pump works at maximum frequency for values equal to or lower than the set window width limit, the frequency decreases as the setpoint value

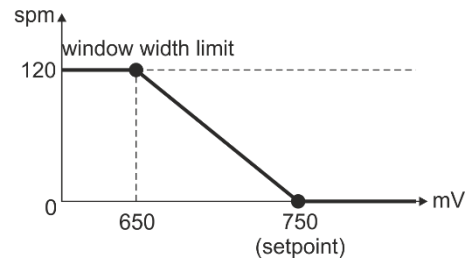

ATTENTION: the pump can also be programmed for the dosage of a Reductive chemical product but it is necessary to check that the seals in the pump body are chemically compatible with the product to be dosed.

Setpoint of Chlorine:

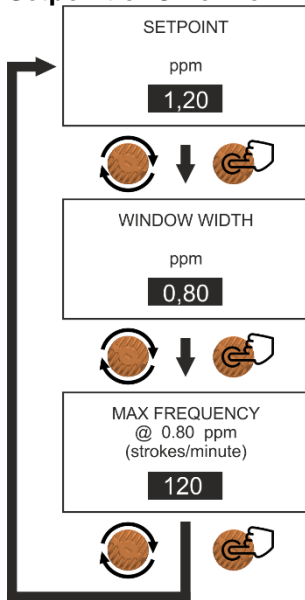

Es. Chlorine:

Setpoint: **1.20 ppm**

Window width limit: **0.80 ppm** (es. 120 strokes/minute);

For values equal to or higher than the Setpoint, the pump is stopped; The pump works at maximum frequency for values equal to or lower than the set window width limit, the frequency decreases as the Setpoint value approaches.

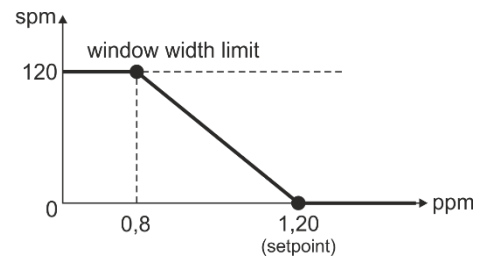

3.5.2 CALIBRATION menu

In order to obtain a precise measurement of the chemical-physical parameters of the water of the plant to be treated, it is necessary, during the installation, to calibrate the probes (pH, Redox or Chlorine).

pH probe calibration

For proper calibration follow the steps described below:

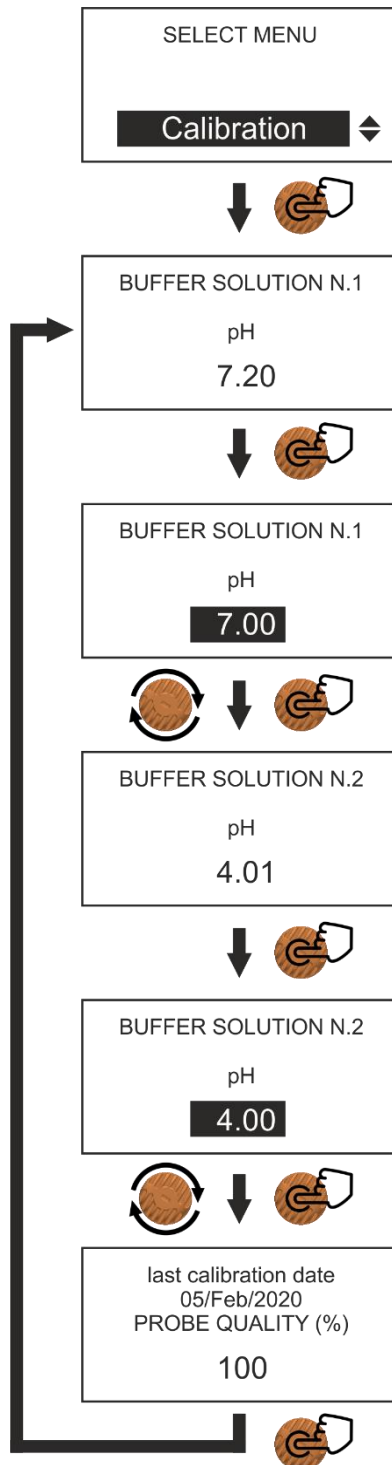

To calibrate the pH electrode, you need two buffer solutions, one at pH 7 and the other at pH 4 or pH 9.

It would be important to measure the temperature of the buffer solution and check the corresponding value on the label of the solution itself; if this measurement cannot be made, skip this step and proceed to the next;

Connect the BNC connector of the electrode to the relative input on the bottom of the pump (refer to the drawing on **paragraph 5** to identify its position);

Remove the protective cap of the electrode then wash it with water and dry it;

Enter in Calibration menu and follow the instructions on the display: dip the electrode in the first buffer solution at pH 7, wait for the measurement to stabilize, if necessary, modify the value read on the display with one on the solution (it can happen that the measurement does not correspond perfectly to the solution, this is perfectly normal). Press on the encoder to confirm this value;

Remove the electrode from the first solution and wash it with water, dry it then dip in the second buffer solution at pH 4 (or pH 9); wait for the measurement to stabilize, if necessary, modify the value read on the display with the one on the solution. Press on the encoder to confirm the value;

At the end of the procedure, the quality of the electrode will be shown on the display.

For values between **25%** and **0%** we suggest replacing the electrode.

Redox probe calibration

For proper calibration follow the steps described below:

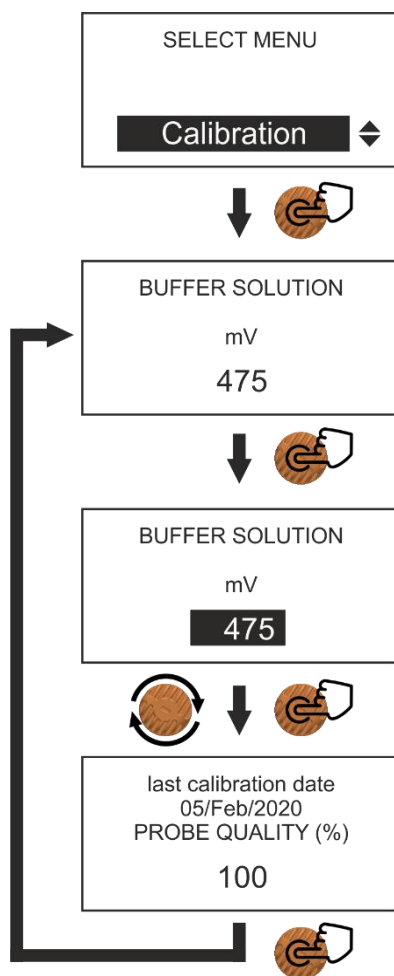

To calibrate the Redox electrode it is necessary to have a buffer solution with a known value (for this example the **475mV** solution was used).

Connect the BNC connector of the electrode to the relative input on the bottom of the pump (refer to the drawing on **paragraph 5** to identify its position);

Remove the protective cap of the electrode then wash it with water and dry it;

Enter in Calibration menu and follow the instructions on the display: dip the electrode in the **475mV** buffer solution, wait for the measurement to stabilize, if necessary, modify the value read on the display with the one on the solution (it may happen that the measurement does not correspond perfectly to solution, this is perfectly normal). Press on the encoder to confirm this value;

At the end of the procedure, the quality of the electrode will be shown on the display.

For values between **25%** and **0%** we suggest replacing the electrode.

Chlorine probe calibration (HC151 + only)

For a correct calibration follow the steps described below:

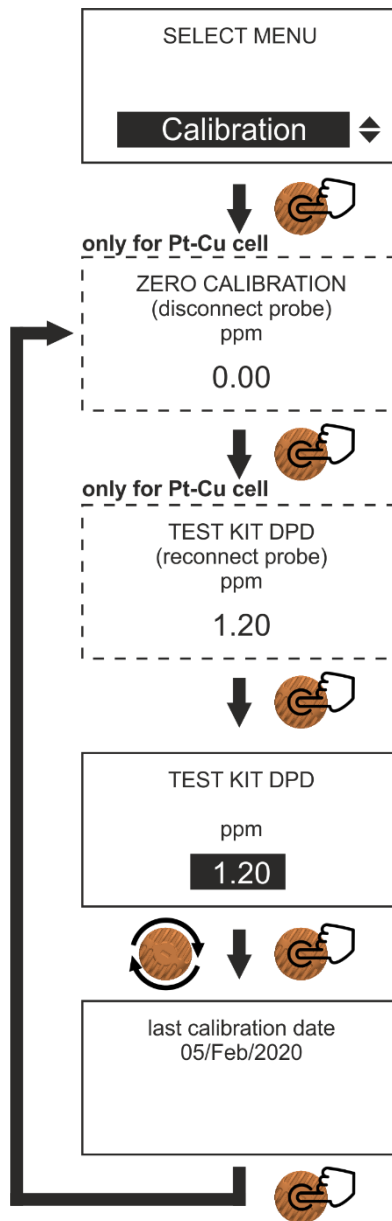

To calibrate the Chlorine probe it is necessary to have a **photometer** and a **DPD test kit**.

ATTENTION: for the membrane chlorine probe (ppm-mV or ppm-mA) follow the probe manufacturer's instructions for the mandatory preliminary operations before being able to connect it to the pump;

Connect the **4-pole** connector of the probe to the relative input on the bottom of the pump (refer to the drawing on paragraph 5 to identify its position);

Install the probe inside the modular probe holder and regulate the flow of water with a constant flow rate of not more than 60 l/h and not less than 30 l/h;

Wait for the polarization of the probe (this can also take several hours: from 1 to 24), the probe manufacturer suggests to wait up to 6 hours before performing the calibration;

ATTENTION: if the Pt-Cu probe is used for the determination of free chlorine, it will also be required to perform zero calibration before the DPD test; stabilization times are reduced to about 1 hour.

Access the Calibration menu and follow the instructions on the display: take a water sample and use the DPD test kit and photometer to determine the Chlorine value, modify the value read on the pump display with the value detected by the photometer. Press on the encoder to confirm this value;

3.6 CORRELATION BETWEEN FREE CHLORINE, pH e REDOX

The graph shown below is useful for understanding the correlation between the measurement of free Chlorine the pH and Redox. In a swimming pool system this information is very useful to verify that there is an "alignment" of all the measures to ensure that the chemical-physical parameters are respected; to better understand the graph, a typical example is described:

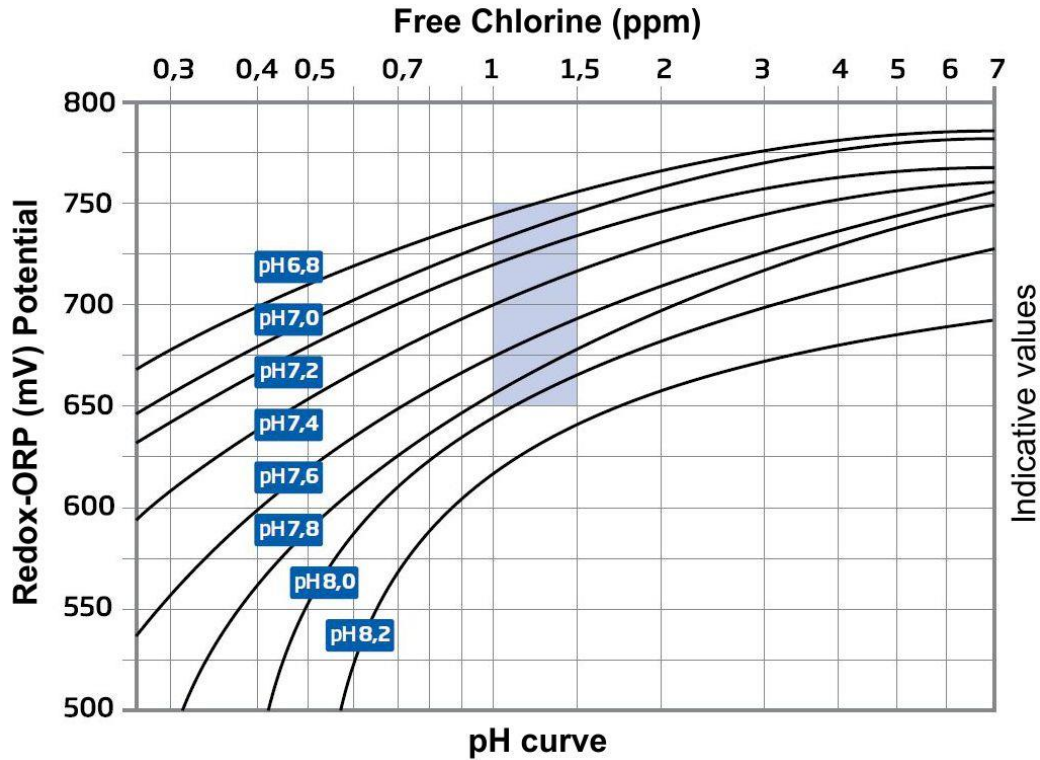

The area highlighted in light blue is the one that indicates the ideal values in a swimming pool system. For example: for pH value of 7.2 (ideal), a Redox value of 725mV corresponds, corresponding to a free Chlorine value of 1.2ppm.

3.7 TIMER SETUP

This menu allows you to operate the dosing pump in order to make it work within a time programmed by the user, each pump function is subject to the activation/deactivation of the timer (if enabled). Here are the steps to set up this feature:

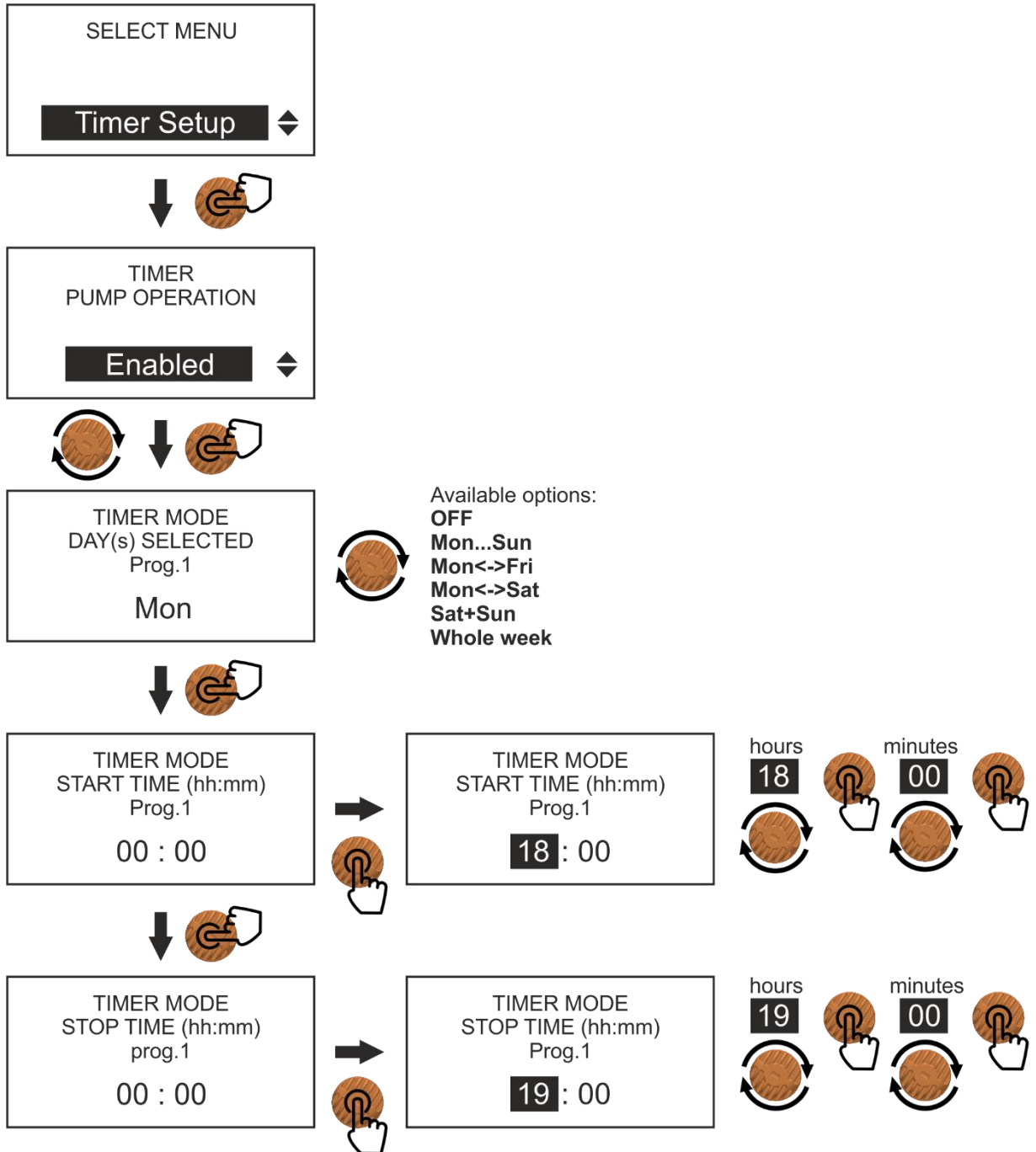

3.8 SETTINGS

3.8.1 General e Security

The settings menu is divided into two categories: **General Settings** and **Security Settings**: in General Settings you will find all those basic settings encountered during the pump initialisation, such as the choice of language, the setting of the date / time, the pump performance, etc. In the Security settings, on the other hand, there are settings such as the choice of the protection password, the delay in activating the level alarm, etc. All possible settings are listed below:

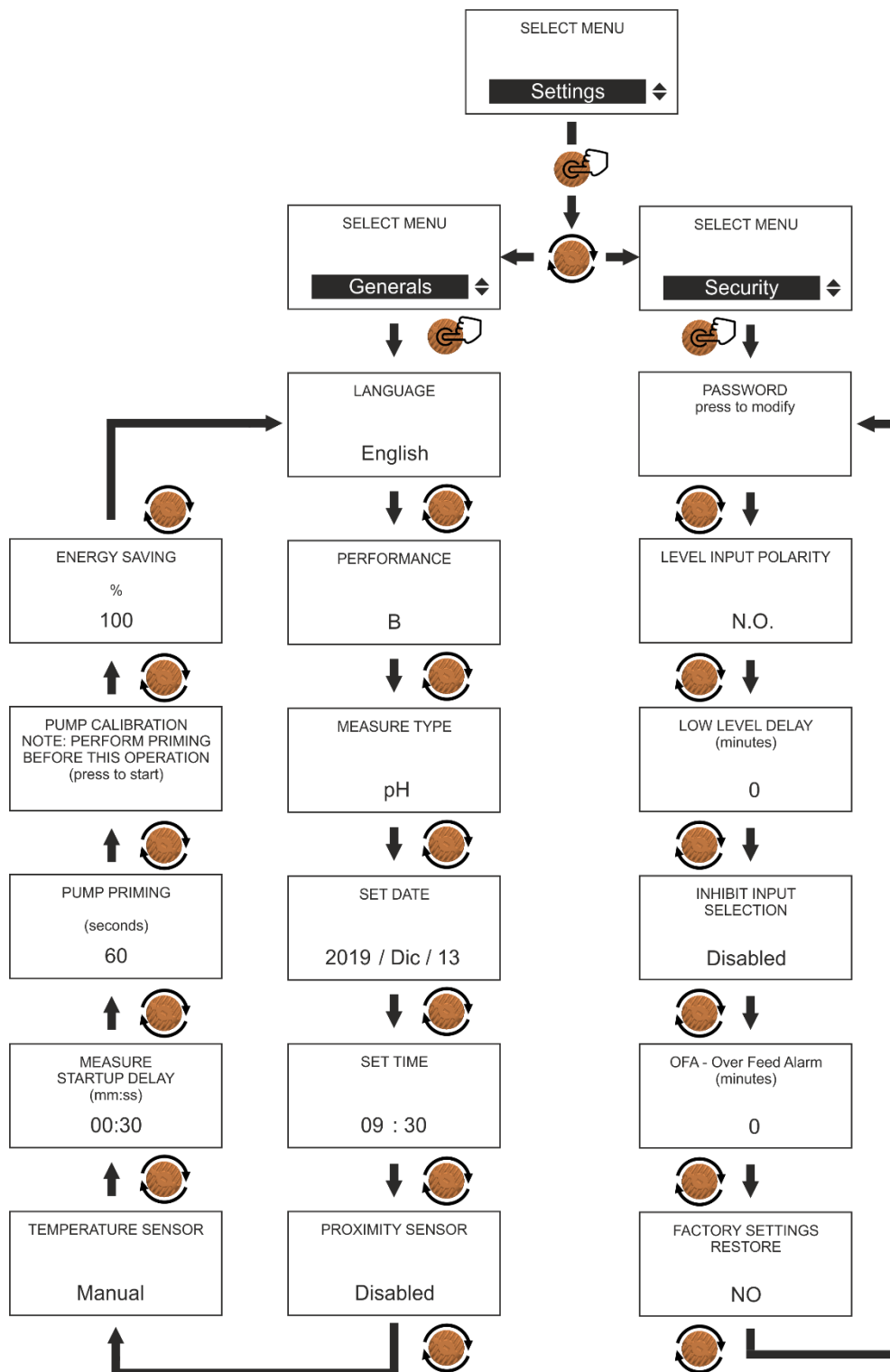

3.8.2 General > Proximity sensor

This function allows you to enable / disable the proximity sensor (not supplied with the pump) which provides, if enabled, the presence or absence of the passage of water inside the electrode holder modules (which need to function correctly of an adequate flow). If there is no flow, the display will show the flashing *FLOW* message.

Here are the steps to set up this feature:

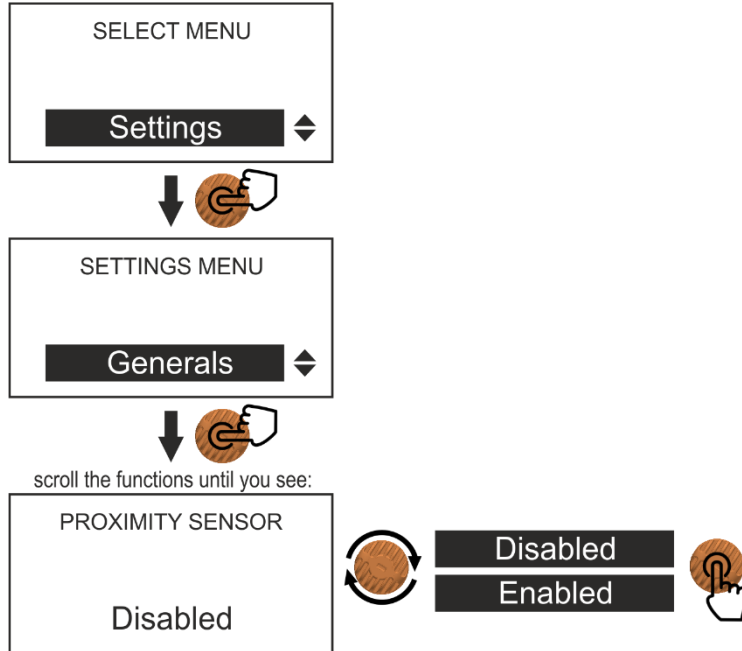

Proximity sensor connection

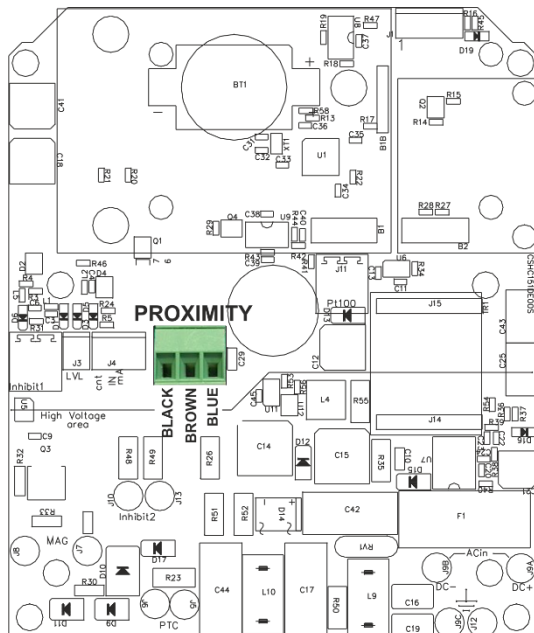

3.8.3 Generals > Temperature probe

This function allows you to enable the temperature sensor (not supplied with the pump) or set a temperature manually. Since the pH of the water in a system is affected by its temperature, there is a need to "compensate" in real time for any changes on the measurement as a function of the detected temperature.

Here are the steps to set up this feature:

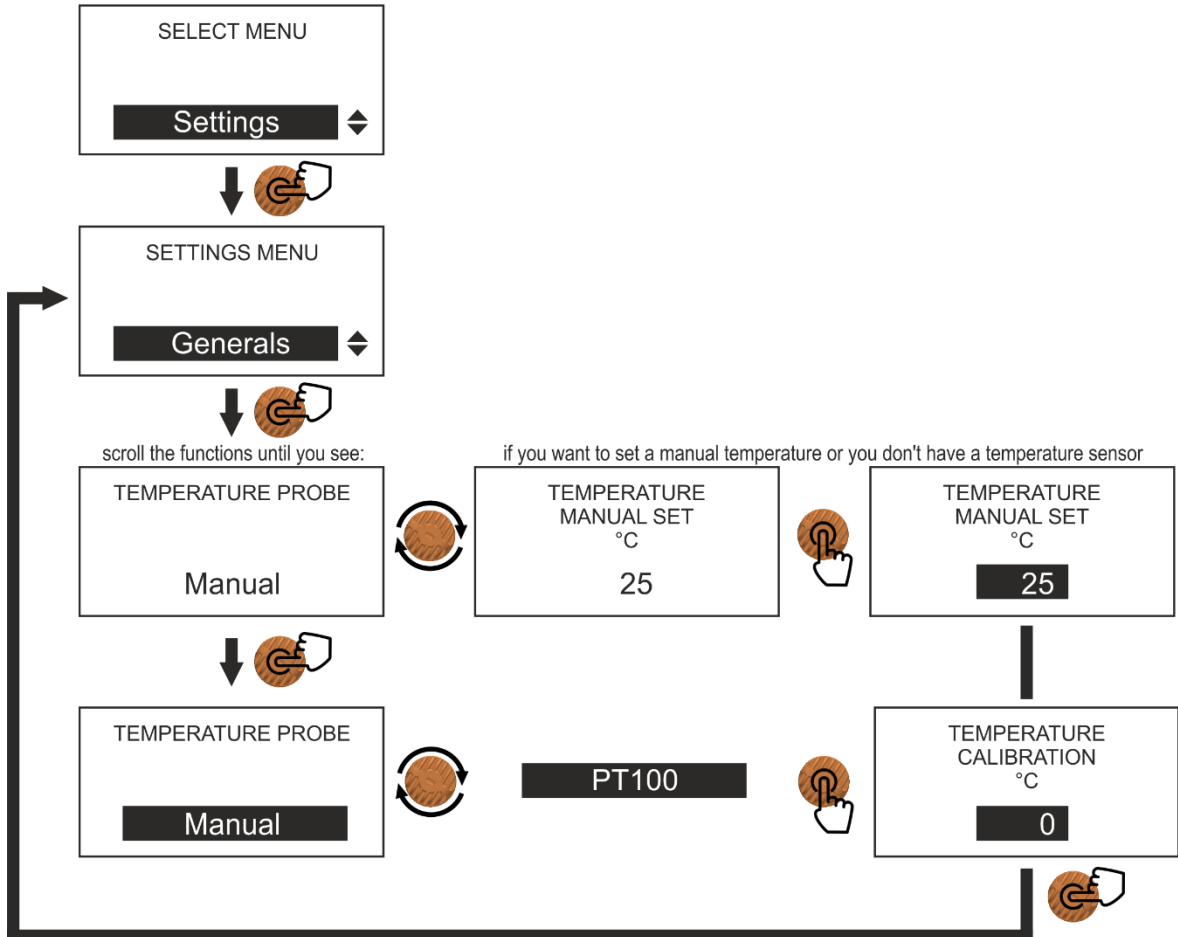

PT100 temperature probe connection

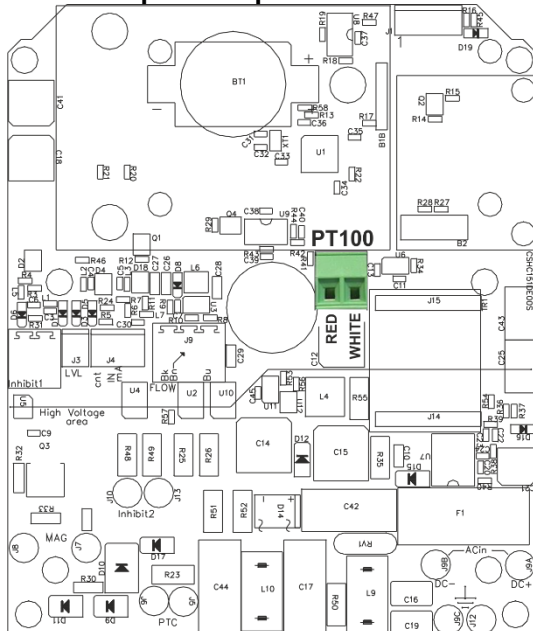

3.8.4 *Generals > Measure startup delay*

Some probes need to polarize before reading the values correctly. If the pump starts dosing during the probe stabilization period, it risks dosing based on incorrect data.

This function allows you to set a time (in minutes or seconds), which allows the probe to stabilize correctly, before the pump starts to dose.

Here are the steps to set up this feature:

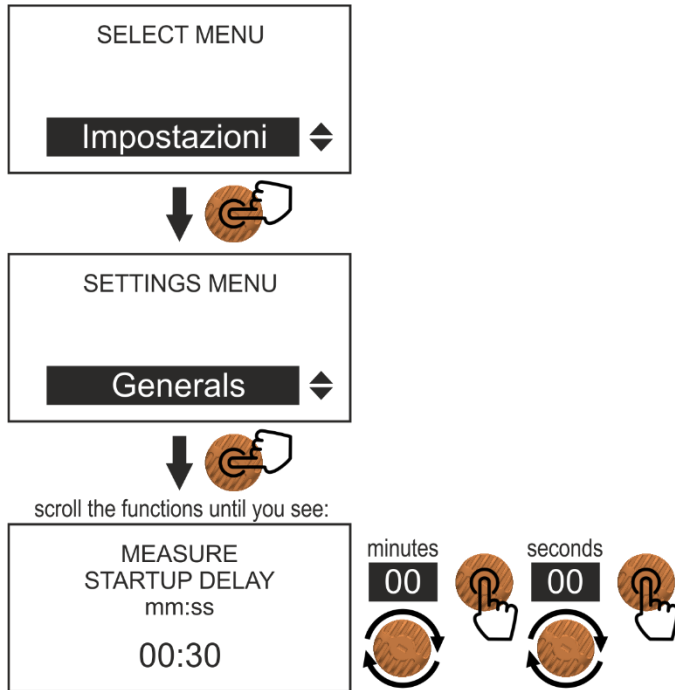

3.7.5 *General > Energy saving*

It is possible to change the brightness of the display during its normal operation, this to limit current absorption and to protect the display from overheating and therefore increase its life. The brightness can be changed from 100% (maximum brightness) to 10% (minimum brightness); once the percentage has been chosen, the display will drop its brightness after 1 minute, if you act on the encoder the brightness will return to the maximum value until it is no longer touched for more than 1 minute. Here are the steps to set up this feature:

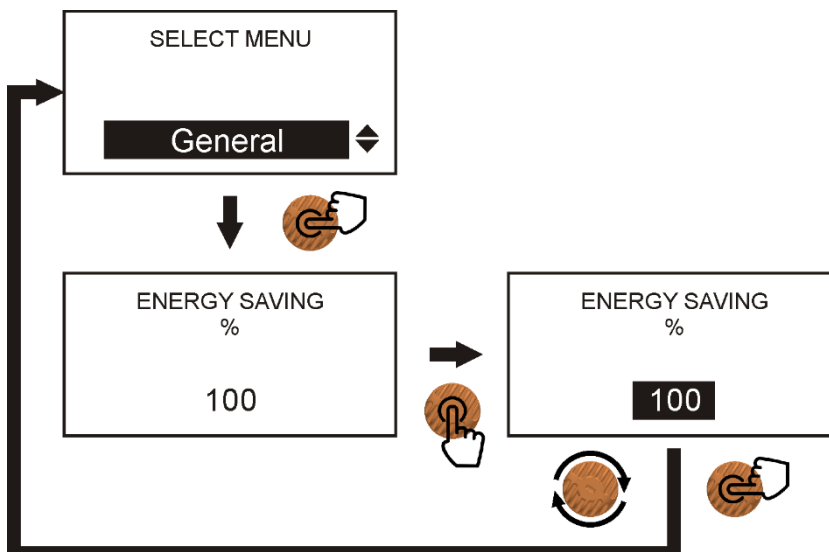

3.8.6 Security > Password

It is possible to set a security password to prevent unauthorized access to the pump configuration menus. **If the user forgets or loses his password, he must contact our Assistance.**

Here are the steps to set up this feature:

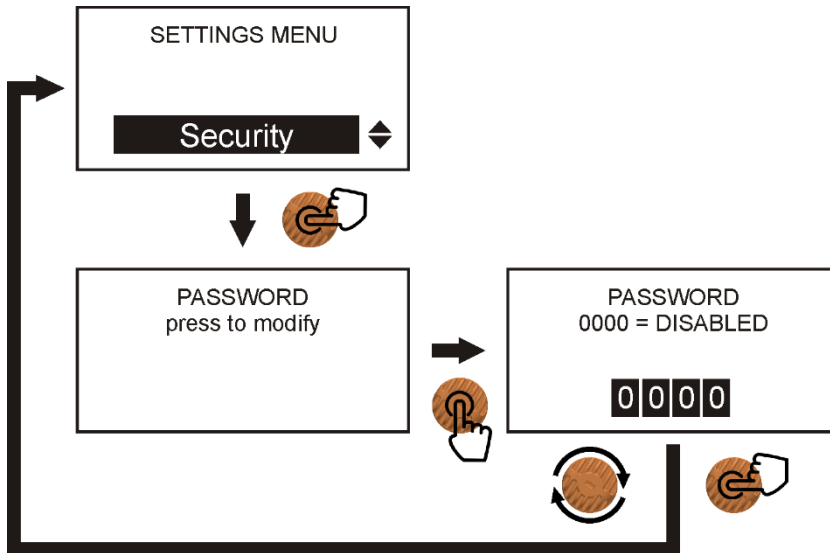

3.8.7 Security > Level Input Polarity

It is possible to invert the polarity of the level probe connected to the pump from Normally Open (N.O.) to Normally Closed (N.C.) and vice versa.

Here are the steps to set up this feature:

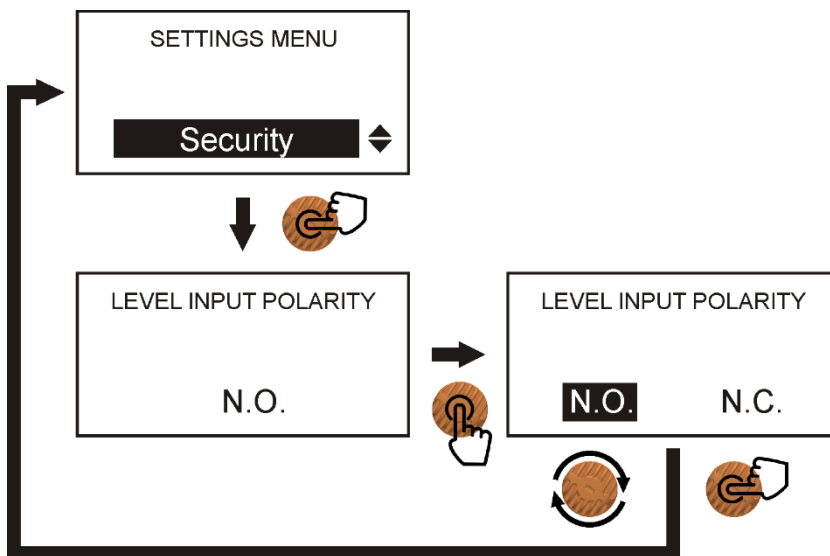

3.8.8 Security > Low Level Delay

With this function it is possible to delay the stop of the pump (and of the dosage) following the activation of the tank level sensor.

When this function is active, and the level of the chemical reaches the minimum, the level alarm is activated on the pump (on display, in the lower right corner, the text * LVL * will appear) but the pump continues to dose for the time set, after which it stops.

When using a suction lance that maintains a safety margin, activating the level (without stopping the dosage) allows you to have time to set up a new tank, without stop the pump dosing. This ensures better continuity of dosage.

ATTENTION: this function must be activated only if you are using the suction lance with safety margin like the LAFL of AQUA SPA (see photo below).

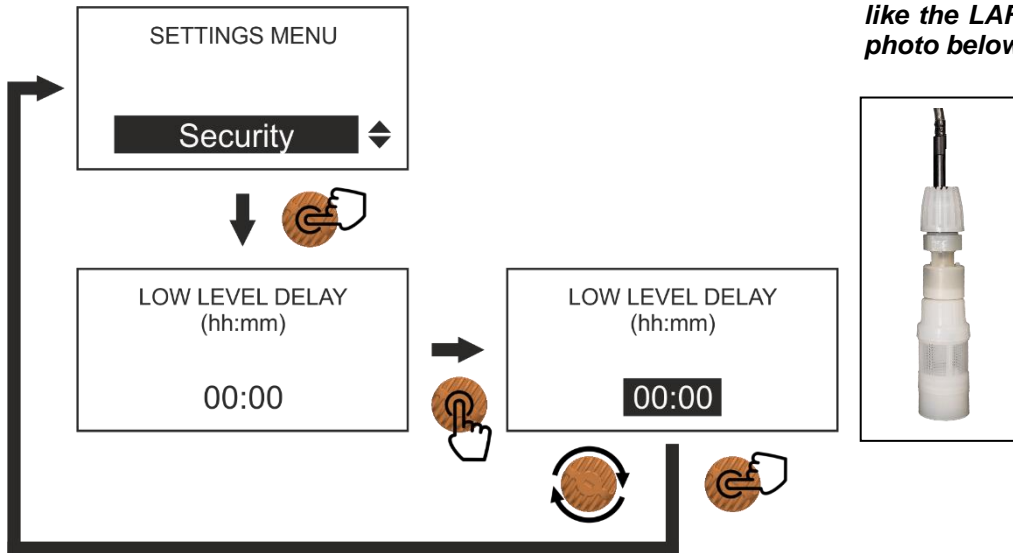

It is possible to set a delay in minutes according to the size of the tank in use and the quantity dosed by the pump.

3.8.9 Security > Inhibit input selection

The HC151+ PHRXCL pump is equipped with two Inhibit inputs (INHIBIT1 and INHIBIT2) which allow it to be connected to a circulation pump, only when this is running, so does the HC151+ pump start dosing. The INHIBIT 1 input is an input with free voltage contacts while the INHIBIT 2 input is live. Below are the steps to set up this feature:

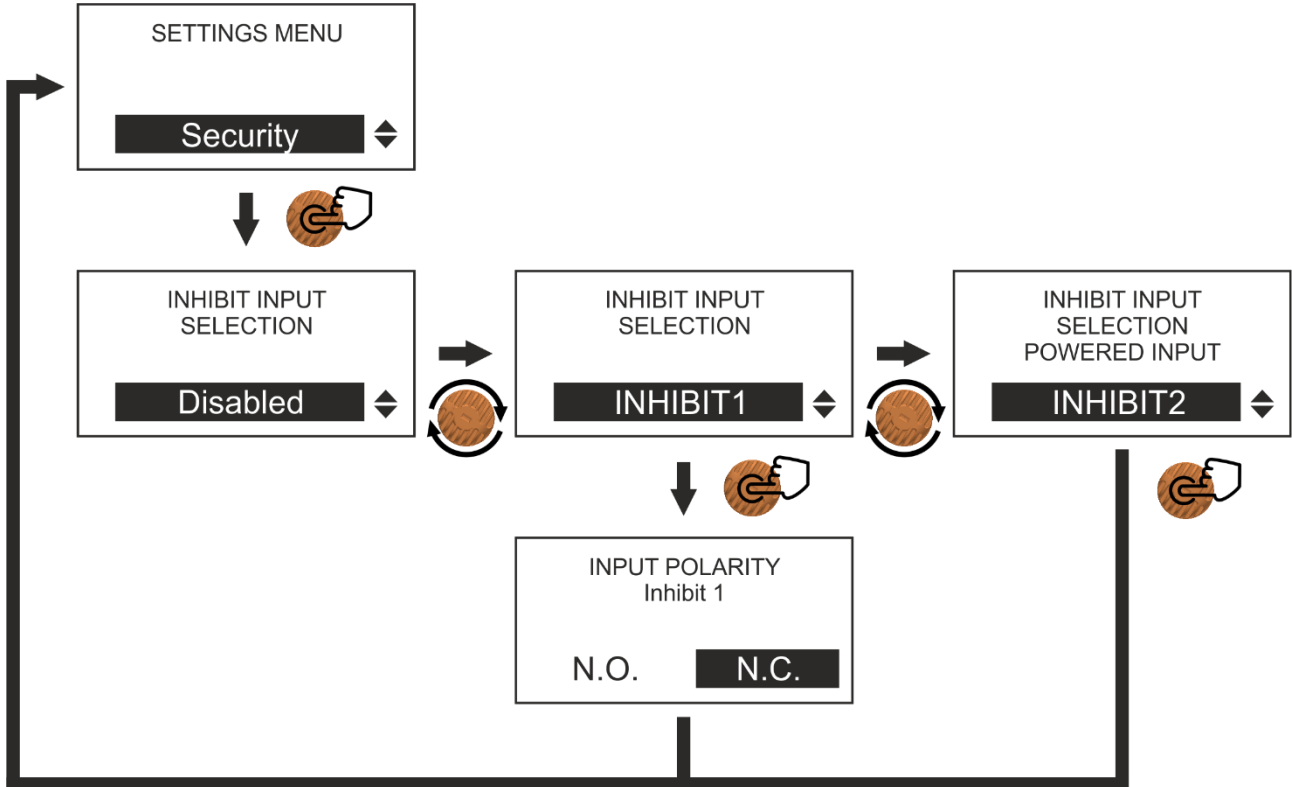

To access the two connectors relating to the INHIBIT inputs 1 and 2 it is necessary to remove the rear cover and identify the connectors as shown in the figures below. **Warning: INHIBIT 2 is a voltage input, before making the connections between the recirculation pump and the dosing pump, disconnect both from the mains. For the connection, use a 2.8x0.8 female faston with faston cover.**

INHIBIT 1 connector location

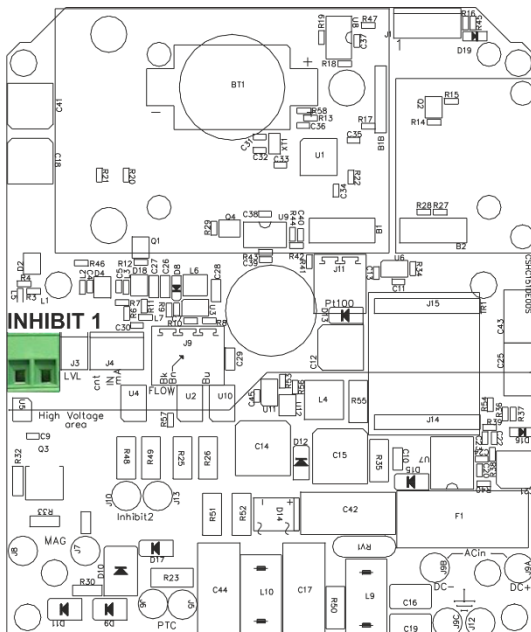

INHIBIT 2 connector location

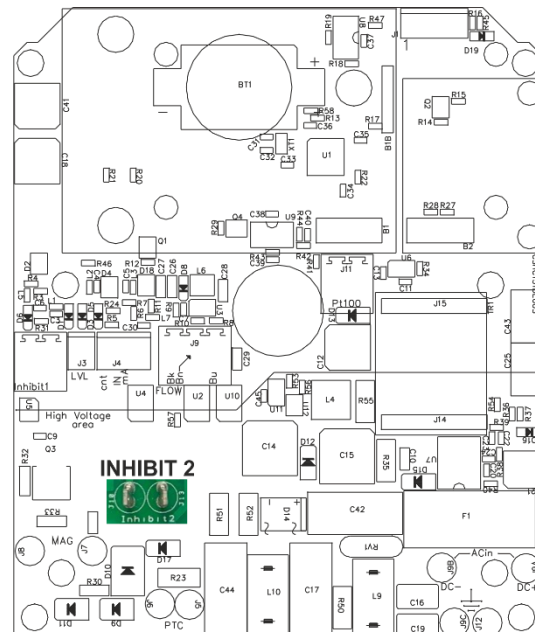

Example of connection with INHIBIT 1 to a circulation pump

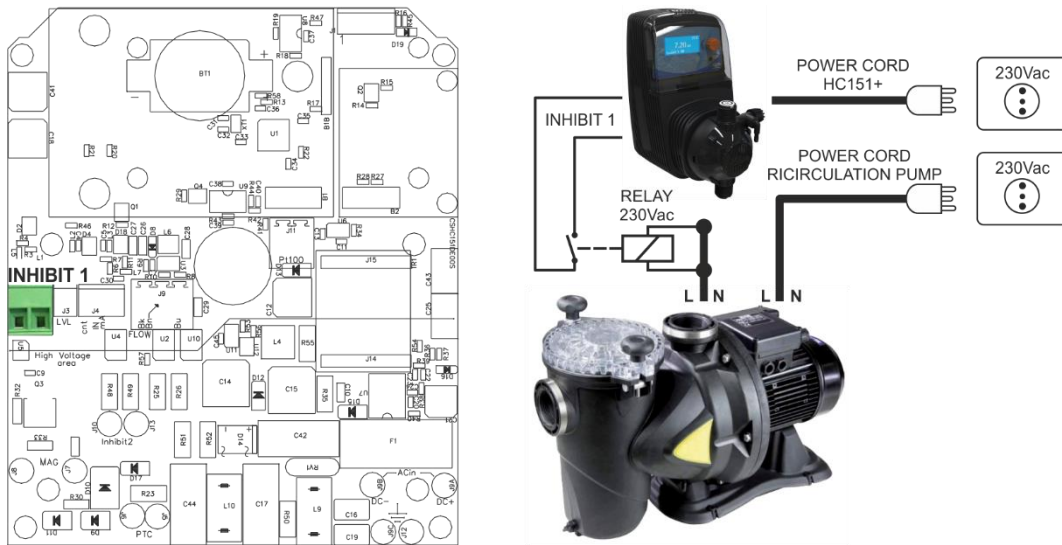

Example of connection with INHIBIT 2 to a circulation pump

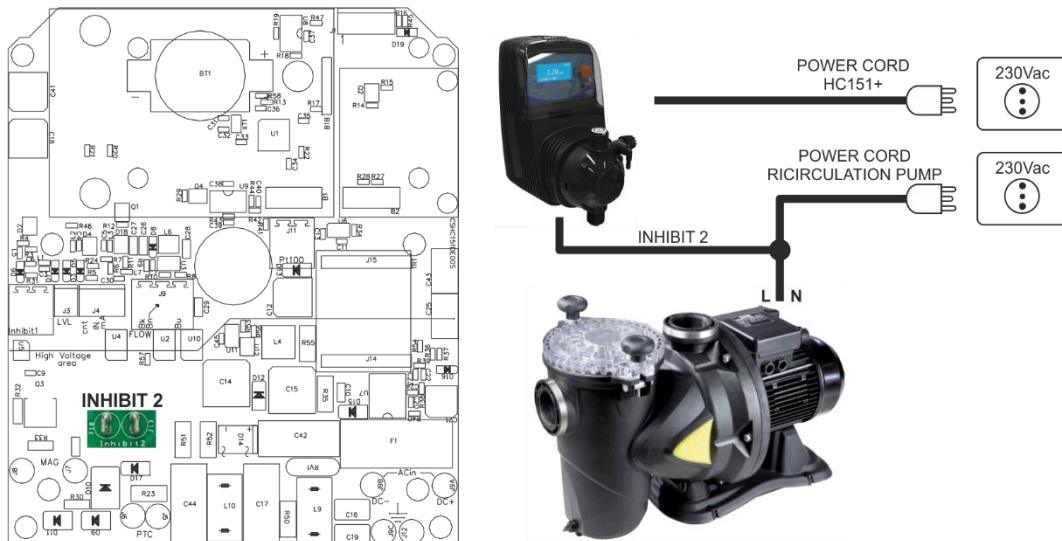

3.8.10 Security > Over Feed Alarm (OFA)

This function, if activated, interrupts the pump operation after the set time, if the setpoint is never reached in this period.

To restore operation, an intervention on the pump is required. It is possible to set a maximum time of 480 minutes

The value "0" corresponds to a disabled function

Here are the steps to set up this feature:

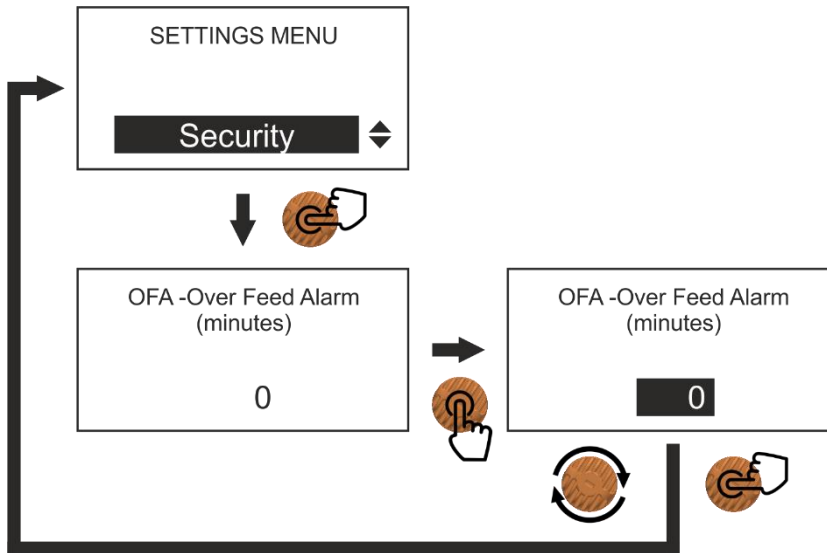

3.8.11 Security > Minimum / Maximum value alarm

It is possible to set an alarm threshold for minimum and maximum measurement values (the alarm does not deactivate the dosage, to reset alarm simply touch the encoder and restore parameters).

Here are the steps to set this function on the pH measurement, but the rule also applies to the Redox and Chlorine measurements:

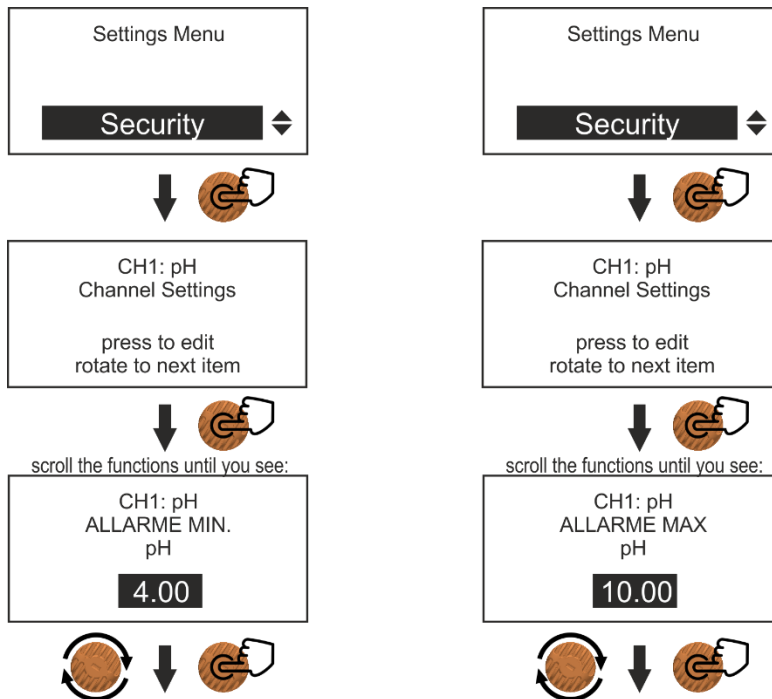

3.8.12 Security > Factory Settings restore

It is possible to reset the pump to factory settings using this function.

ATTENTION: this will delete all the data previously set and all the statistics with the exception of the counter of the total strokes (see paragraph 3.10).

Here are the steps to set up this feature:

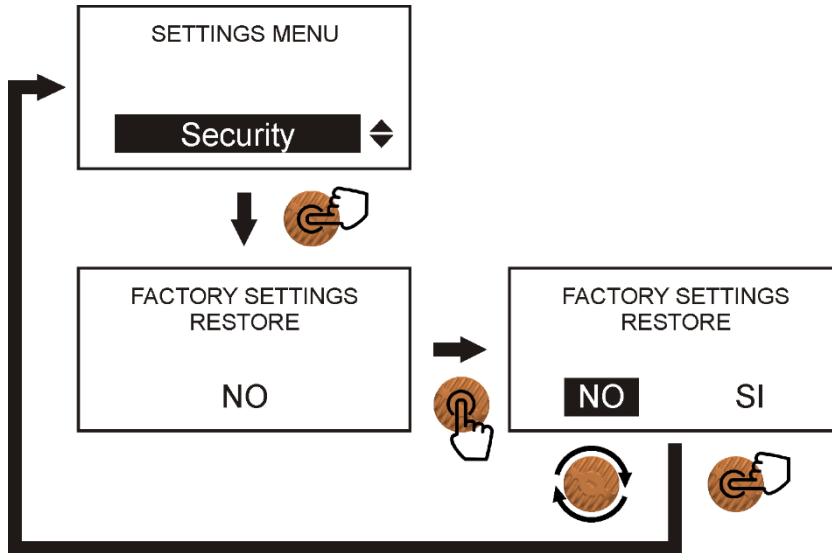

3.9 STATISTICS

During normal pump operation, the electronic board stores some data during its operation; these data can be viewed within the "STATISTICS" menu. In this menu you can find the number of total strokes and the volume delivered (in liters).

Here are the steps to set up this feature:

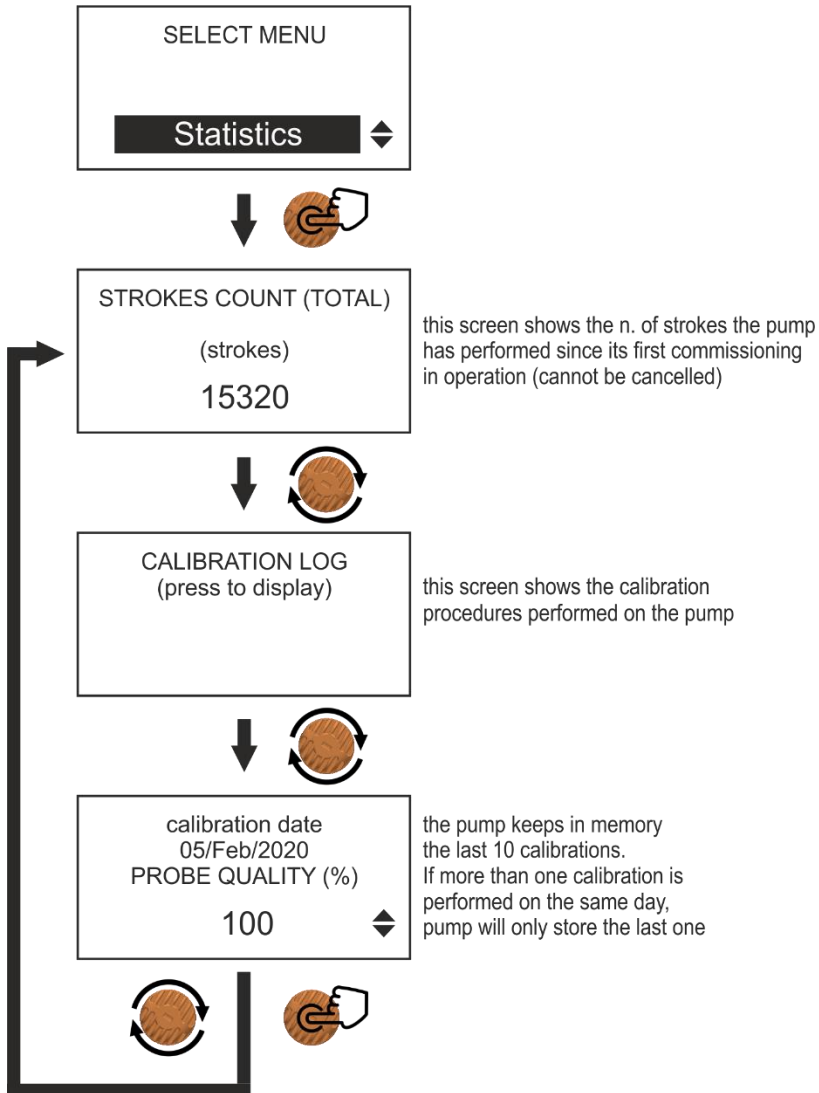

4. DOSING PUMPS INSTALLATION RULES

Strictly follow the instructions for a correct installation of the dosing pump to avoid malfunctions. The most frequent cases are described below:

- Locate the pump as shown in Figure 1, bearing in mind that it can be mounted either below or above the level of the chemical to be dosed within the maximum limit of 2 meters (we suggest 1.5 meters). The injection point must always be placed higher than the chemical to be injected.
- If the system to be treated works at atmospheric pressure and the chemical tank must absolutely be positioned higher than the injection point (Figure 2), periodically check the functionality of the injection valve (I), as its excessive wear could lead to unintentional injection of the chemical into the plant due to gravity (even with the dosing pump stopped). If the problem persists, insert a counter-pressure valve (V) correctly calibrated between the dosing pump and the injection point.
- For chemicals that emit aggressive fumes, do not install the pump on top of the tank unless the tank is hermetically sealed (Figure 3).

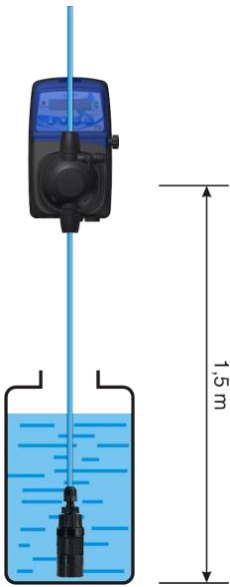

Figure 1

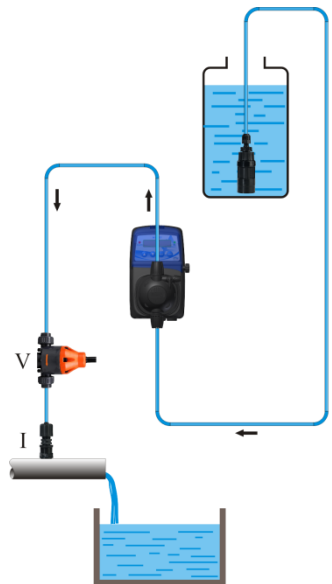

Figure 2

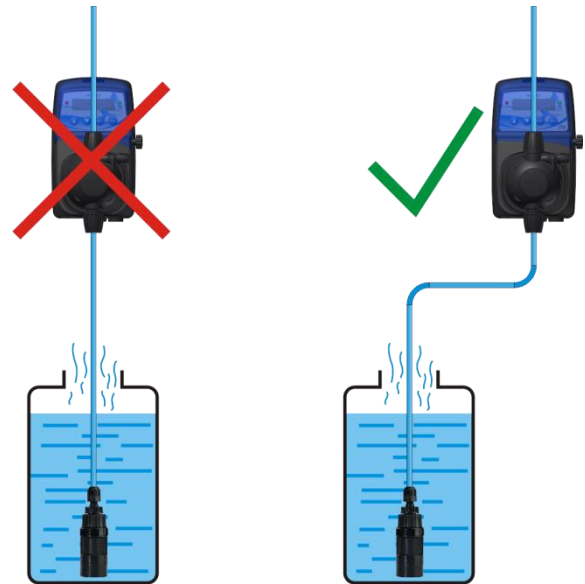
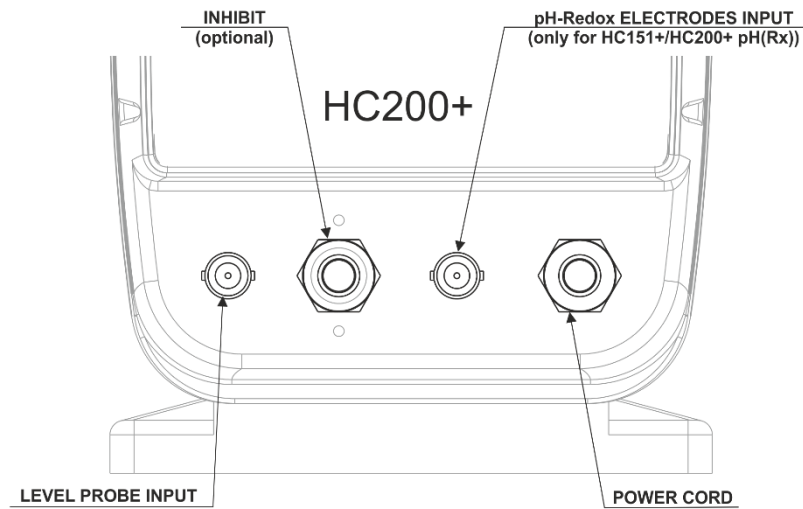
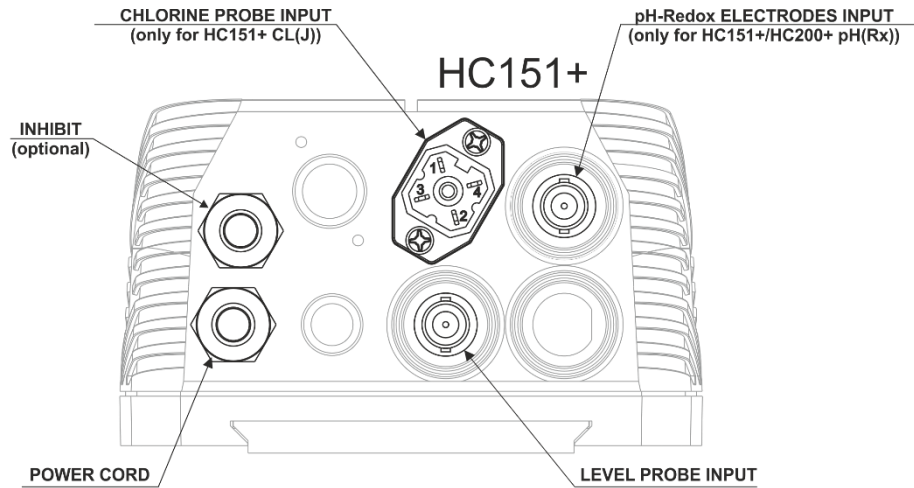

Figure 3

5. ELECTRICAL CONNECTIONS

5.1 HC151+ PlmA model pump

The connector on the bottom of the pump allows the connection of an external signal coming from a pulse emitting water meter or a mA signal. Obviously, if a pulse emitting water meter is connected, a mA signal cannot be connected and vice versa. The pump is also equipped with a BNC connector for connecting a level probe (not included in the package).



HOW TO CONNECT THREE DIFFERENT CHLORINE PROBES

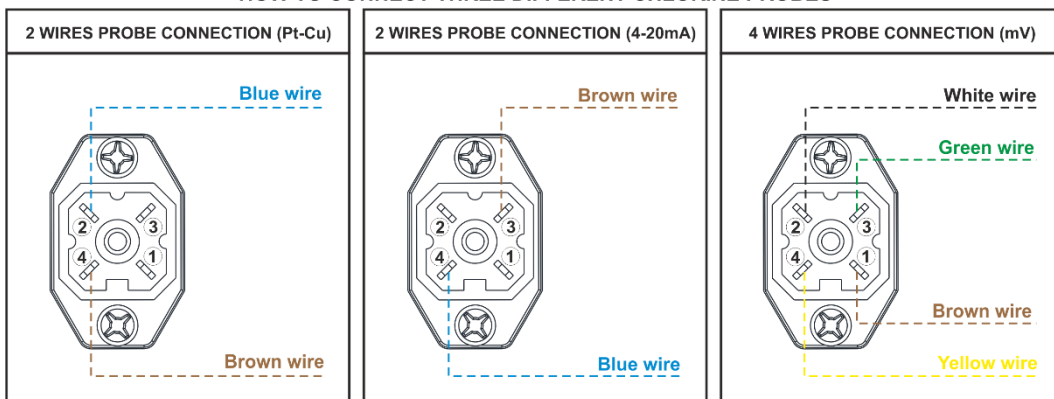

6. TROUBLESHOOTING

The solenoid driven dosing pump is a relatively robust device, therefore the chances of mechanical failures are low. Sometimes chemical leaks may occur from nipples or loose hose nuts of the pump head or simply due to breakage of the discharge pipe. If one of the above cases occurs, user has to first disconnect the unit from the power supply, then replaces the damaged part, cleans the unit from any chemical leaks, then restart the pump.

6.1 PROBLEM – CAUSE – SOLUTION

Below are listed some of the problems that may occur, the causes and solutions

PROBLEM	POSSIBLE CAUSE	SOLUTION
The pump does not switch on	The pump is not powered The protection fuse is blown up. The electronic board is damaged	Connect the pump to the mains. Replace the fuse. Replace the electronic board.
The pump does not dose but the solenoid is working	The foot filter is obstructed. The suction tube is empty, the pump is not primed. Air bubbles in the hydraulic circuit. The chemical in use generates gas	Clean the foot filter. Repeat the priming procedure. Check nipples and hoses Open the bleed valve and let the air goes out. Replace the pump head with automatic bleed version.
The pump does not dose and the solenoid does not works or the stroke is greatly muffled.	Crystals formation, valve occlusion and / or the balls are blocked. The injection valve is obstructed	Clean the valves and try to circulate water instead of the chemical product. Replace the valves of the pump head. Replace the injection valve.

7. MAINTENANCE

7.1 CLEANING THE PUMP

The pump must be periodically cleaned in order to ensure its efficiency. We suggest to carry out regular cleaning during maintenance period.

Before carrying out any maintenance or cleaning operations on the dosing pump, it is necessary to:

1. Make sure that it is electrically disabled (both polarities) by disconnecting the conductors from the contact points of the power supply by opening the omnipolar switch;
2. Eliminate in the most appropriate and gradual way, (paying the utmost attention not to generate splashes), the existing pressure in the pump body and in the delivery pipe, by opening the appropriate air bleed valve.
3. Remove the protective cover of the pump body, to highlight any underlying leaks and encrustations;
4. Clean any incrustations due to leaks or drips on the pump body or on the entire pump structure, paying particular attention to the lower part of the pump where, usually, any incrustations due to drips accumulate;
5. Reassemble the cover of the pump body, the delivery and suction pipes, close the air bleed valve and reconnect the pump electrically;
6. Carry out priming if necessary and restore the normal operating status of the pump.

7.2 PUMP MAINTENANCE

Under normal operating conditions, the metering pump should be checked monthly. To avoid malfunctions or sudden stops, carefully check the following items:

- check that the electrical and hydraulic connections are intact;*
- check for any leaks on the connections of the pump head or the injection valve;*
- check that there are no parts of the pump or pipes corroded.*

Always empty the pump head from chemical, if there could still be presence of dangerous chimica inside the pump head it is mandatory to declare it filling the RETURN MATERIAL AUTHORIZATION module. Always use original spare parts if it is necessary to replace worn parts

All technical assistance operations must be performed only by expert and authorized personnel. If the pump requires direct assistance from the manufacturer, it is necessary to remove all the liquid inside the pump head and dry it BEFORE packing it in its original box!

8. WARRANTY

The product is covered by the manufacturer's warranty for manufacturing defects. The methods and conditions are set forth in the "General Conditions of Sale" document of AQUA SpA.

EXPLODED VIEWS

HC151+

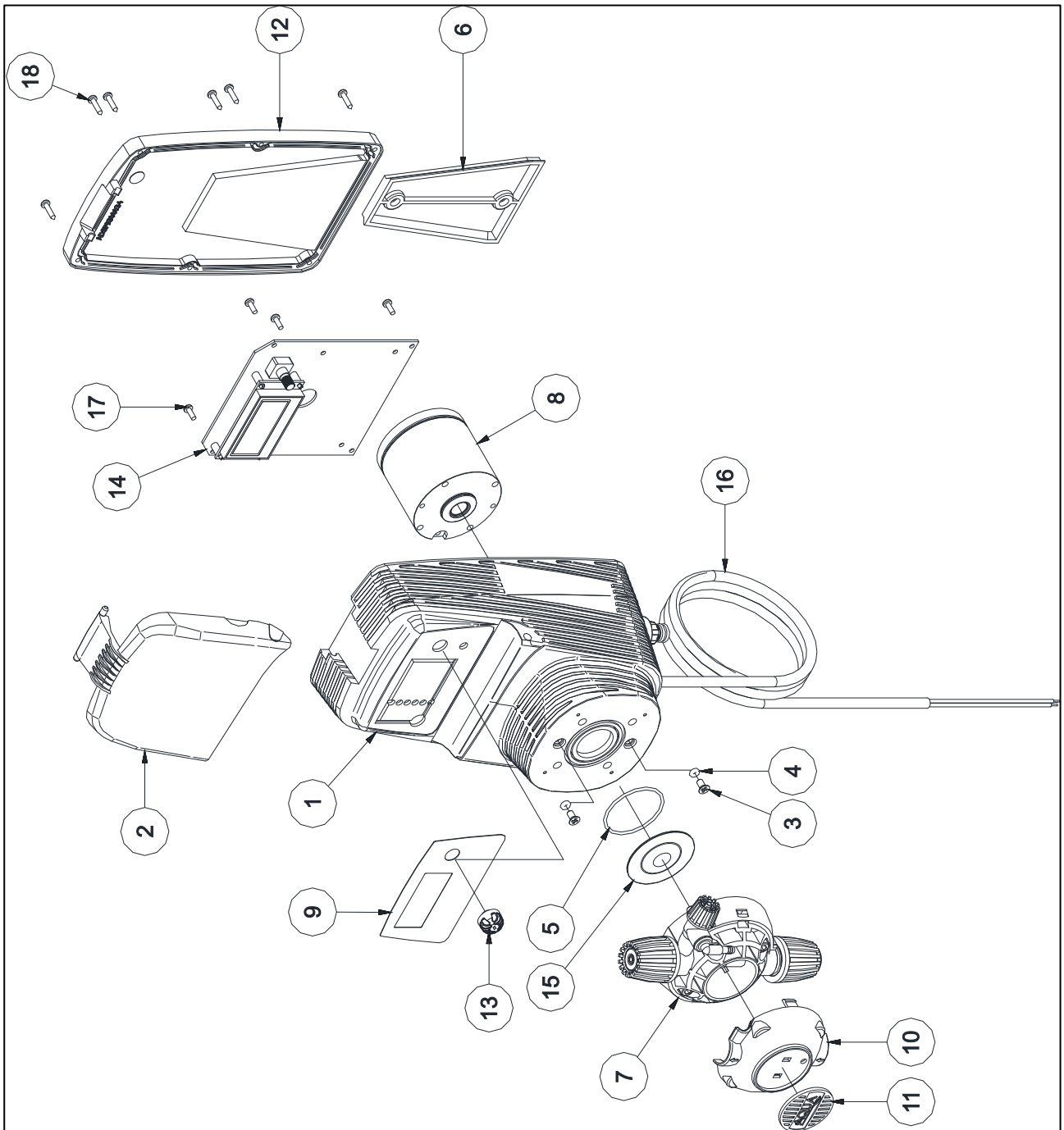

HC151+

N°	Codice Code	Descrizione Description	Quantità Quantities
1	ADSP9300058	CASSA HC151+ PP+20% FV NERA HC 151+ PP+20% GF BLACK HOUSING	1
2	ADSP9300061	VETRINO TRASPARENTE HC151+ HC151+ TRANSPARENT FRONT COVER	1
3	ADSP6000708	VITE M4X8 UNI 7688 (AF-TSTC) INOX A2 M4X8 UNI 7688 (AF-TSTC) SS A2 SCREW	2
4	ADSP5007072	OR "R1" NBR – 2,60X1,90 NBR – 2,60X1,90 O-RING	2
5	ADSP5007117	OR – RIF. 2150 – FPM FPM 2150 ORING	1
6	ADSP6020221	STAFFA FISSAGGIO A PARETE WALL FIXING BRACKET	1
7	ADSP9000105	CORPO POMPA 1-14 PVDF-CE-VT INCOMPLETO 1-14 PVDF-CE-VT INCOMPLETE PUMP HEAD	1
7	ADSP900PI06	CORPO POMPA 1-14 PVDF-CE-DT INCOMPLETO 1-14 PVDF-CE-DT INCOMPLETE PUMP HEAD	1
8	ADSP6000295	MAGNETE COMPLETO D60 VERS.2 230V SILENZIOSO 230V D60 COMPLETE SOLENOID	1
8	ADSP6000287	MAGNETE COMPLETO D70 230V – CORSA CORTA - SILENZIOSO 230V D70 COMPLETE SOLENOID	1
8	ADSP6000536	MAGNETE COMPLETO D80 4I/20bar 230V – (MOD.8) - SILENZIOSO 230V D80 COMPLETE SOLENOID	1
9	ADSP7000772	ETICHETTA POLICARBONATO HC151+ MULTI/PH-RX-CL HC151+ MULTI/PH-RX-CL POLICARBONATE ADHESIVE LABEL	1
10	ADSP9000022	COVER NERO CORPO POMPA 1-14LT HC897 1-14LT PUMP HEAD BLACK COVER	1
11	ADSP9000003	TARGHETTA NERA CON LOGO AQUA PER CORPO POMPA 1-14LT 1-14LT PUMP HEAD BLACK PLATE WITH LOGO AQUA	1
12	ADSP9300034L	COPERCHIO POSTERIORE HC151 DGT PP NERO CON GUARNIZ. HC151 DGT PP BACK COVER WITH GASKET	1
13	ADSP9300072	MANOPOLA ENCODER HC151+ HC151+ KNOB FOR ENCODER	1
14	ADSP9300084	SKD HC151+ PH-RX 100÷240Vac HC151+ PH-RX 10÷240Vac ELECTRONIC BOARD	1
14	ADSP9300085	SKD HC151+ CL(J) 100÷240Vac HC151+ CL(J) 10÷240Vac ELECTRONIC BOARD	1
15	ADSP9200001	DIAFRAMMA PTFE DYNEON 1614/1645 1-14L HC897 M12x1 1614/1645 1-14L HC897 M12x1 PTFE DYNEON DIAPHRAGM	1
16	ADSP6020281	CAVO H05VV-F 3x0,75 METRI 3 + PRESSACAVO PG7 E FASTON FEMMINA 2,8x0,8 H05VV-F 3x0,75 POWER SUPPLY CABLE 3 METERS W/OUT PLUG	1
17	ADSP6000749	VITE 3x8 (TCTC) INOX A2 – SERIE HILO 3x8 SS A2 HILO SERIES SCREW	4
18	ADSP6000714	VITE 2,9x13 UNI 6954 (TCTC) 2,9x13 UNI6954 SCREW	6

HC200+

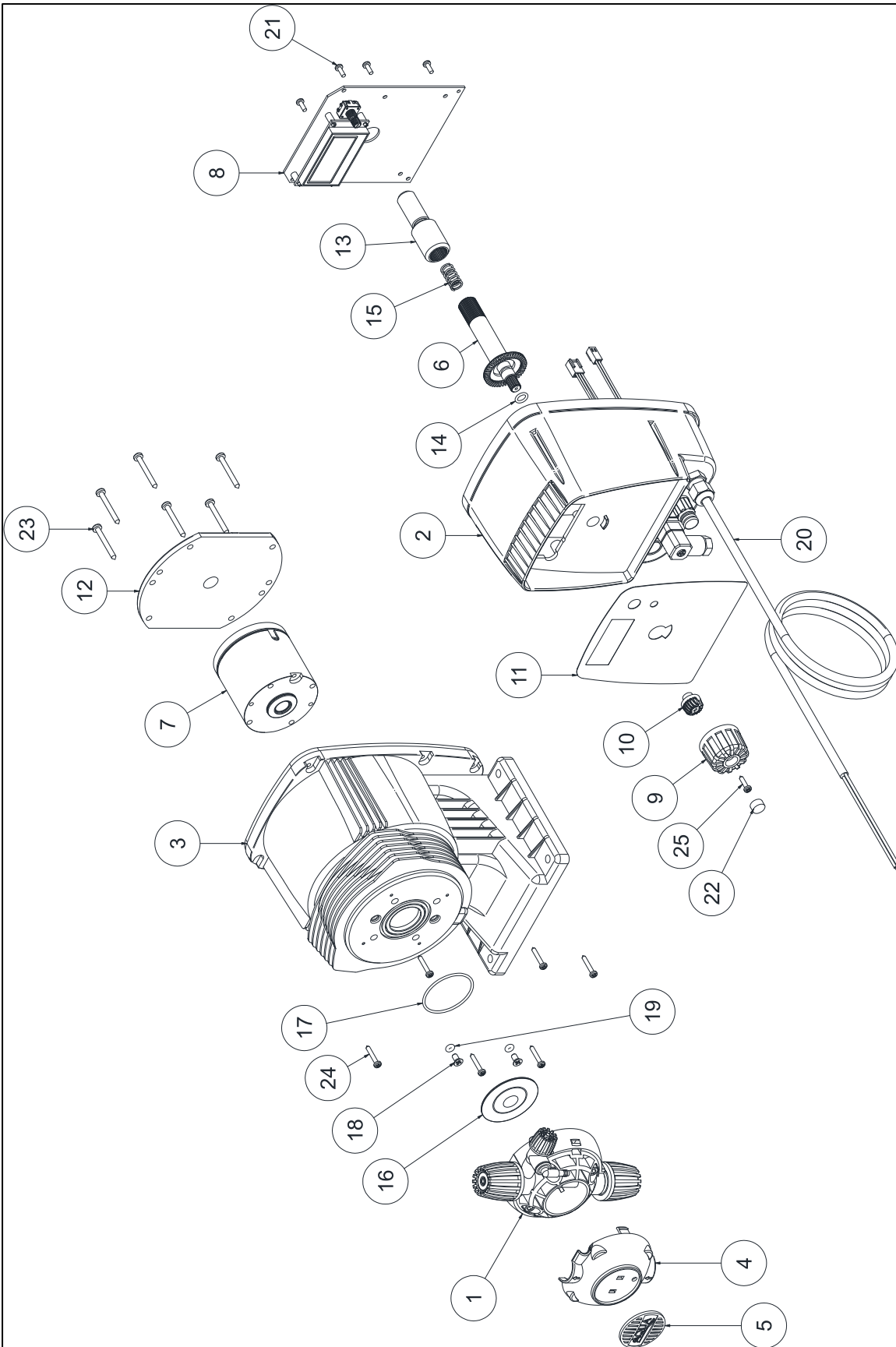

HC200+

N°	Codice Code	Descrizione Description	Quantità Quantities
1	ADSP900PI05	CORPO POMPA 1-14 PVDF-CE-VT INCOMPLETO <i>1-14 PVDF-CE-VT INCOMPLETE PUMP HEAD</i>	1
1	ADSP900PI06	CORPO POMPA 1-14 PVDF-CE-DT INCOMPLETO <i>1-14 PVDF-CE-DT INCOMPLETE PUMP HEAD</i>	1
2	ADSP9300063	CASSA ANTERIORE HC200+ NERA <i>HC200+ FRONT CASING BLACK COLOR</i>	1
3	ADSP9300059	CASSA POSTERIORE HC200+ NERA <i>HC200+ REAR CASING BLACK COLOR</i>	1
4	ADSP9000022	COVER NERO CORPO POMPA 1-14LT HC897 <i>1-14LT PUMP HEAD BLACK COVER</i>	1
5	ADSP9000003	TARGHETTA NERA CON LOGO AQUA PER CORPO POMPA 1-14LT <i>1-14LT PUMP HEAD BLACK PLATE WITH LOGO AQUA</i>	1
6	ADSP6000759	PERNO REGOLAZIONE CORSA LAVORATO <i>STROKE LENGTH SHAFT</i>	1
7	ADSP6000295	MAGNETE COMPLETO D60 VERS.2 230V SILENZIOSO <i>230V D60 COMPLETE SOLENOID</i>	1
7	ADSP6000287	MAGNETE COMPLETO D70 230V – CORSA CORTA - SILENZIOSO <i>230V D70 COMPLETE SOLENOID</i>	1
8	ADSP9300084	SKD HC151+ PH-RX 100÷240Vac <i>HC151+ PH-RX 10÷240Vac ELECTRONIC BOARD</i>	1
9	ADSP6000507	MANOPOLA REGOLAZIONE CORSA AQUA <i>STROKE LENGHT ADJUSTMENT KNOB</i>	1
10	ADSP9300072	MANOPOLA ENCODER HC151+ <i>HC151+ KNOB FOR ENCODER</i>	1
11	ADSP7000774	ETICHETTA POLICARBONATO HC200+ MULTI/PH-RX <i>HC200+ MULTI/PH-RX POLICARBONATE ADHESIVE LABEL</i>	1
12	ADSP6000738	INSERTO REGOLAZIONE CORSA 04-18 CON PIASTRA <i>04-18 STROKE LENGTH ADJUSTMENT INSERT WITH PLATE</i>	1
13	ADSP6000739	VITE REGOLAZIONE CORSA 04-18 <i>04-18 STROKE LENGTH ADJUSTMENT SCREW</i>	1
14	ADSP5007035	OR – RIF. 106 – FPM <i>FPM 106 O-RING</i>	1
15	ADSP5003021	MOLLA RITORNO REGOLAZIONE CORSA HC101 <i>HC101 RETURN SPRING STROKE LENGHT ADJUSTMENT</i>	1
16	ADSP9200001	DIAFRAMMA PTFE DYNEON 1614/1645 1-14L HC897 M12x1 <i>1614/1645 1-14L HC897 M12x1 PTFE DYNEON DIAPHRAGM</i>	1
17	ADSP5007117	OR – RIF. 2150 – FPM <i>FPM 2150 ORING</i>	1
18	ADSP6000708	VITE M4X8 UNI 7688 (AF-TSTC) INOX A2 <i>M4X8 UNI 7688 (AF-TSTC) SS A2 SCREW</i>	2
19	ADSP5007072	OR "R1" NBR – 2,60X1,90 <i>NBR – 2,60X1,90 O-RING</i>	2
20	ADSP6020281	CAVO H05VV-F 3x0,75 METRI 3 + PRESSACAVO PG7 E FASTON FEMMINA 2,8x0,8 <i>H05VV-F 3x0,75 POWER SUPPLY CABLE 3 METERS W/OUT PLUG</i>	1
21	ADSP6000749	VITE 3x8 (TCTC) INOX A2 – SERIE HILO <i>3x8 SS A2 HILO SERIES SCREW</i>	4
22	ADSP6000542	TAPPO IN PVC NERO PER VITE M4 <i>PVC CAP FOR M4 SCREW</i>	1
23	MB010300	VITE 3,5 X 32 UNI 6954 (AF-TCTC) INOX A2 <i>3,5 X 32 STAINLESS STEEL SCREW</i>	6
24	ADSP6000800	VITE 2,9 X 19 UNI 6954 (AF-TCTC) INOX A2 <i>2,9 X 19 STAINLESS STEEL SCREW</i>	6
25	ADSP6000714	VITE 2,9 X 13 UNI 6954 (AF-TCTC) INOX A2 <i>2,9 X 13 STAINLESS STEEL SCREW</i>	1

PUMP HEAD EXPLODED VIEW

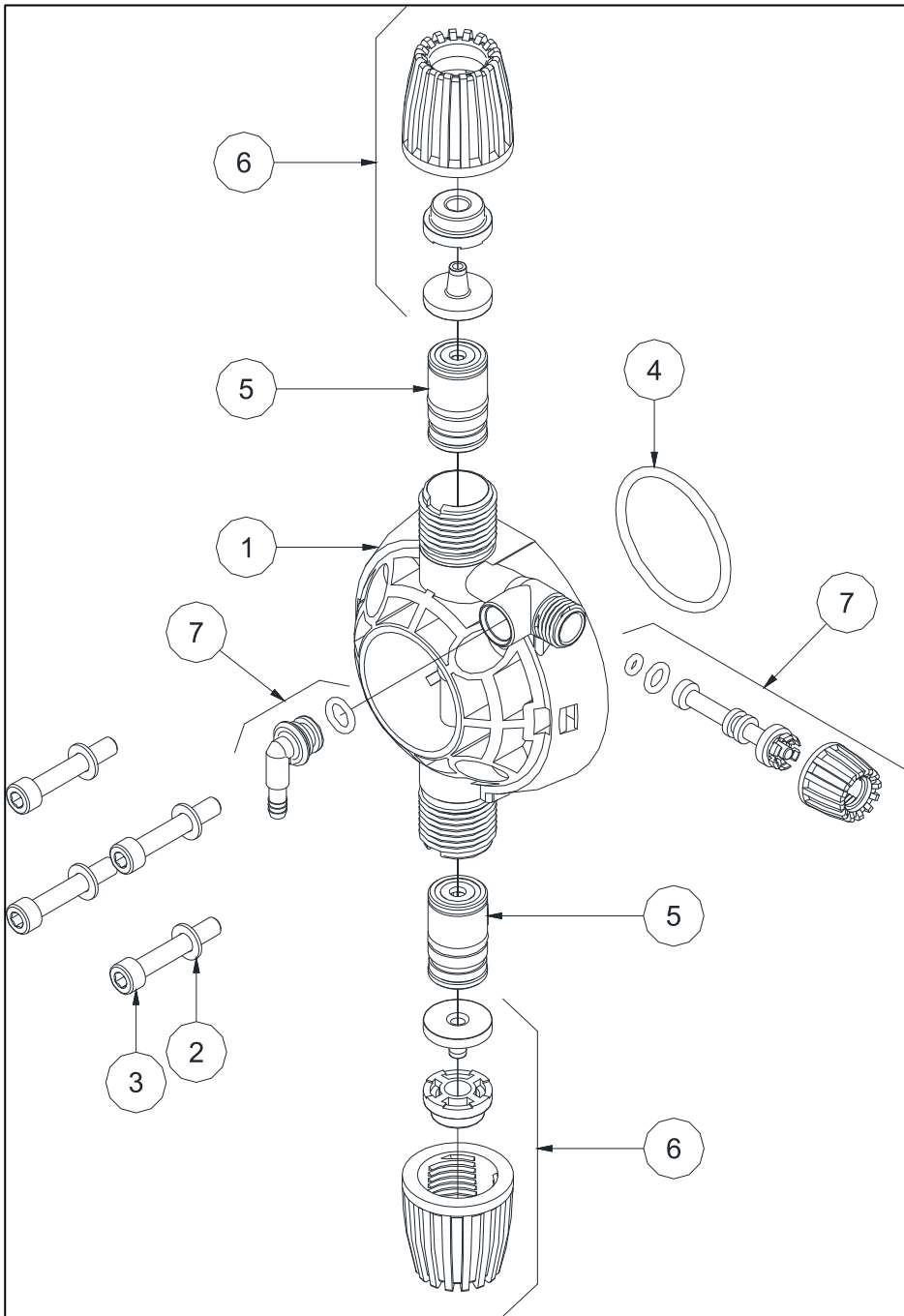

CORPO POMPA PP / PP PUMP HEAD



CORPO POMPA PVDF / PVDF PUMP HEAD



PUMP HEAD EXPLODED VIEW

N°	Codice Code	Descrizione Description	Quantità Quantities
1	ADSP9000001	CORPO POMPA 1-14 PP NERO HC897M (VN) <i>1-14 PP BLACK PUMP HEAD</i>	1
1	ADSP9000001P	CORPO POMPA 1-14 PVDF BIANCO HC897 <i>1-14 PVDF WHITE PUMP HEAD</i>	1
2	ADSP6000701	RONDELLA PIANA D. 5 – UNI 6592 INOX A2 <i>D.5 WASHER – UNI 6592 SS A2</i>	4
3	ADSP9000016	VITE M5x30 UNI 5931 (TCEI) INOX A2 <i>M5x30 UNI 5931 SS A2 SCREW</i>	4
4	ADSP5007200	OR – RIF. 3143 (T.2,62xD.36,14) – FPM NERO <i>FPM 3143 (T.2,62xD.36,14) ORING</i>	1
4	ADSP5007209	OR – RIF. 3143 (T.2,62xD.36,14) – EPDM NERO <i>EPDM 3143 (T.2,62xD.36,14) ORING</i>	1
5	ADSP9005010	KIT GRUPPO VALVOLA ½" PP-GL-VT <i>½" PP-GL-VT VALVE KIT</i>	1
5	ADSP9005011	KIT GRUPPO VALVOLA ½" PP-GL-DT <i>½" PP-GL-DT VALVE KIT</i>	1
5	ADSP9005P12	KIT GRUPPO VALVOLA ½" PVDF-CE-VT <i>½" PVDF-CE-VT VALVE KIT</i>	1
5	ADSP9005P13	KIT GRUPPO VALVOLA ½" PVDF-CE-DT <i>½" PVDF-CE-DT VALVE KIT</i>	1
6	ADSP6500059	KIT FISSAGGIO PP ½" PER TUBO 4x6 <i>½" PP FIXING KIT FOR 4x6 HOSE</i>	1
6	ADSP6500060	KIT FISSAGGIO PVDF ½" PER TUBO 4x6 <i>½" PVDF FIXING KIT FOR 4x6 HOSE</i>	1
6	ADSP6500067	KIT ATTACCO TUBO 6x8 CON GHIERA DA ½" PP NERA <i>6x8 FIXING KIT WITH ½" BLACK PP HOSE NUT</i>	2
6	ADSP6500068	KIT ATTACCO TUBO 6x9 CON GHIERA DA ½" PP NERA <i>6x8 FIXING KIT WITH ½" BLACK PP HOSE NUT L</i>	2
6	ADSP6500063	KIT ATTACCO TUBO 6x10 CON GHIERA DA ½" PP NERA <i>6x8 FIXING KIT WITH ½" BLACK PP HOSE NUT</i>	2
7	ADSP6500072	KIT VITE SPURGO + PORTAGOMMA PP-VT CORPO POMPA <i>AIR BLEED KIT + PP-VT HOSE FITTING FOR PUMP HEAD</i>	1
7	ADSP6500072P	KIT VITE SPURGO + PORTAGOMMA PVDF-VT CORPO POMPA <i>AIR BLEED KIT + PP-VT HOSE FITTING FOR PUMP HEAD</i>	1
7	ADSP6500073	KIT VITE SPURGO + PORTAGOMMA PP-DT CORPO POMPA <i>AIR BLEED KIT + PP-DT HOSE FITTING FOR PUMP HEAD</i>	1
7	ADSP650073P	KIT VITE SPURGO + PORTAGOMMA PVDF-DT CORPO POMPA <i>AIR BLEED KIT + PVDF-DT HOSE FITTING FOR PUMP HEAD</i>	1

AUTO BLEED PUMP HEAD EXPLODED VIEW

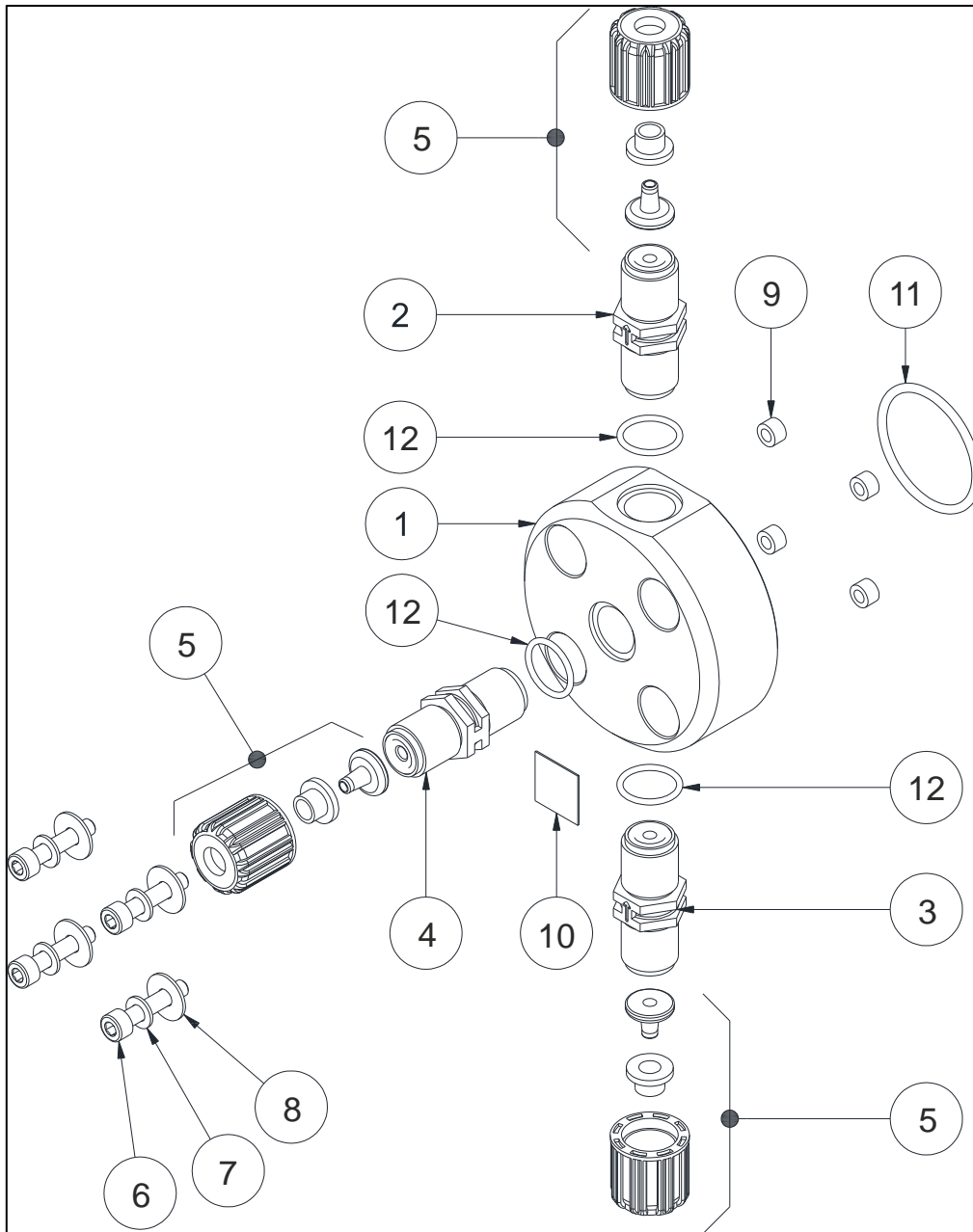

AUTO BLEED PUMP HEAD EXPLODED VIEW

N°	Codice Code	Descrizione Description	Quantità Quantities
1	ADSP9000029	CORPO POMPA 1-14 PVC SPURGO AUTOMATICO 1-14 PVC AUTO BLEED PUMP HEAD	1
2	ADSP5005033	GRUPPO VALVOLA 3/8" PER SPURGO PP-CE-VT 3/8" PP-CE-VT DEGAS VALVE KIT	1
2	ADSP5005133	GRUPPO VALVOLA 3/8" PER SPURGO PP-CE-DT (OR2015 PTFE) 3/8" PP-CE-DT DEGAS VALVE KIT	1
2	ADSP5005036	GRUPPO VALVOLA 3/8" PER SPURGO PVDF-CE-VT 3/8" PVDF-CE-VT DEGAS VALVE KIT	1
2	ADSP5005038	GRUPPO VALVOLA 3/8" PER SPURGO PVDF-CE-DT 3/8" PVDF-CE-DT DEGAS VALVE KIT	1
3	ADSP5005031	GRUPPO VALVOLA 3/8" PP-CE-VT 3/8" PP-CE-VT VALVE KIT	1
3	ADSP5005131	GRUPPO VALVOLA 3/8" PP-CE-DT 3/8" PP-CE-DT VALVE KIT	1
3	ADSP5005034	GRUPPO VALVOLA 3/8" PVDF-CE-VT 3/8" PVDF-CE-VT VALVE KIT	1
3	ADSP5005037	GRUPPO VALVOLA 3/8" PVDF-CE-DT 3/8" PVDF-CE-DT VALVE KIT	1
4	ADSP5005032	GRUPPO VALVOLA 3/8" PP-CE-HAST-VT 3/8" PP-CE-HAST-VT VALVE KIT	1
4	ADSP5005132	GRUPPO VALVOLA 3/8" PP-CE-HAST-DT 3/8" PP-CE-HAST-DT VALVE KIT	1
4	ADSP5005035	GRUPPO VALVOLA 3/8" PVDF-CE-HAST-VT 3/8" PVDF-CE-HAST-VT VALVE KIT	1
4	ADSP5005135	GRUPPO VALVOLA 3/8" PVDF-CE-HAST-DT 3/8" PVDF-CE-HAST-DT VALVE KIT	1
5	ADSP6500048	KIT FISSAGGIO PP 3/8" PER TUBO 4X6 3/8" PP FIXING KIT FOR 4X6 HOSE	3
5	ADSP6500013	KIT FISSAGGIO PVDF 3/8" PER TUBO 4X6 3/8" PVDF FIXING KIT FOR 4X6 HOSE	3
6	MB010040	VITE M5x25 UNI 5931 (TCEI) INOX A2 M5x25 UNI 5931 SS A2 SCREW	4
7	ADSP6000701	RONDELLA PIANA D. 5 – UNI 6592 INOX A2 D. 5 WASHER – UNI 6592 SS A2	4
8	MB010460	RONDELLA PIANA 5x15 – UNI 6592 INOX A2 5x15 WASHER – UNI 6592 SS A2	4
9	ADSP5007011	BUSSOLA PER CORPO POMPA D. 3,2 x 6,45 x 5,5 SANT64A PUMP HEAD SCREW GASKET D. 3,2 x 6,45 x 5,5 SANT64A	4
10	ADSP7000442	ETICHETTA FLOW PER COLLARE PORTASONDA DN50-63 FLOW DIRECTION LABEL	1
11	ADSP5007200	OR – RIF. 3143 (T.2,62 x D.36,14) FPM NERO FPM 3143 (T.2,62 x D.36,14) ORING	1
11	ADSP5007209	OR – RIF. 3143 (T.2,62 x D.36,14) EPDM NERO EPDM 3143 (T.2,62 x D.36,14) ORING	1
12	ADSP5007001	OR – RIF. 2062 – FPM NERO FPM 2062 - ORING	3
12	ADSP5007002	OR – RIF. 2062 – EPDM NERO EPDM 2062 - ORING	3



USE AND MAINTENANCE INSTRUCTIONS MANUAL FOR DOSING PUMP

HC151+ pH(Rx)-CL(J) / HC200+ pH(Rx)