

BTS
ENGINEERING

<https://prom-nasos.pro>

<https://bts.net.ua>

<https://prom-nasos.com.ua>

+38 095 656-37-57,

+38 067 360-71-01,

+38 063 362-12-31,

info@prom-nasos.pro

**USE AND
MAINTENANCE INSTRUCTIONS**

**HC999 MOD. D
PI-MA-CLK CLJ**

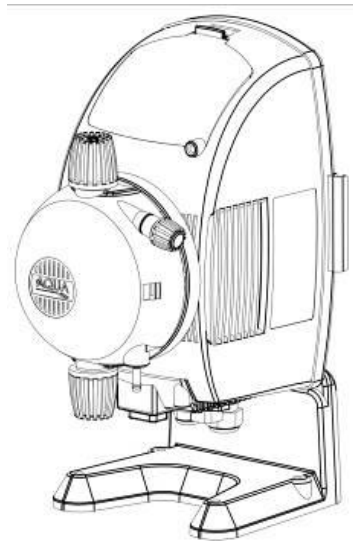

HC999



INDUSTRIAL GROUP





FILTRATION - DOSING - DETERGENT & HYGIENE - POOL EQUIPMENT



DECLARATION OF CONFORMITY

Company:	AQUA S.p.A.
Address:	Via T. Crotti, 1 - 42018 - San Martino in Rio (RE)

Hereby declares that the products named:

- **HC899**
- **HC999**

Responds to the principal features of the following European Directives:

- **2014/30/CE of 26/02/2014** - *Harmonization of the laws of the Member States relating to electromagnetic compatibility – EMC Directive*
- **2014/35/CE of 26/02/2014** - *Harmonization of the laws of the Member States relating to the making available on the market of electrical equipment designed for use within certain voltage limits – Low Voltage Directive*
- **2011/65/UE of 08/06/2011 with subsequent update 2015/863 of 31/03/2015** - *ROHS III Directives*
- **2012/19/UE of 04/07/2012** - *WEEE Directives for electrical and electronic waste*

This declaration is issued under the responsibility of Aqua S.p.A.

San Martino in Rio (RE) - 08 settembre 2020

Davide Vezzani
Certification Manager - Aqua S.p.A. |

AQUA S.p.A.

Società soggetta a direzione e coordinamento di Finanza Cooperativa S.c.p.a. - Cap. Soc. € 10.052.498,00 - Iscritto e Versato
S. Martino in Rio - 42018 - Reggio Emilia - ITALY - Sede legale: Via Crotti, 1 - Sede operativa: Via Bersaglia, 3 - Cod. Fisc. e P.IVA 02026440380 - Reg. Imprese di RE 02026440380
Ph. +39.0522.695805 - Fax +39.0522.646168 - www.aqua.it - email: aqua@aqua.it



1.0 GENERAL COMMENTS	4
1.1 Warnings	4
1.2 Shipping and transporting the pump	4
1.3 Use of the pump	4
1.4 Design standard	5
2.0 INTRODUCTION	5
3.0 TECHNICAL CHARACTERISTICS	5
3.1 General rules	5
3.2 Standard accessories supplied	6
3.3 Electrical Characteristics	6
3.4 Hydraulic Characteristics	6
3.5 Electrical connection	7
3.6 Hydraulic connection	7
3.7 Operation	8
4.0 FUNCTIONING FEATURES	9
4.1 Other functioning features	9
4.2 User interface	10
4.3 Power supply	11
5.0 USER MENU	12
5.1 Pause the pump	12
5.2 Priming the pump	12
5.3 Adjusting the Chlorine setpoint	12
6.0 PROGRAMMING	12
6.1 Enter in programming mode	12
6.2 Programming menu	13
6.3 Programming menu – Constant functioning	13
6.4 Programming menu – Proportional functioning	16
6.5 Programming menu – Timer	22
6.6 Programming menu – Settings and Calibration	24
7.0 DEFAULT PARAMETERS	30
8.0 SIGNALS INPUT	30
9.0 MAINTENANCE	32
9.1 General maintenance comments	32
9.2 Periodic maintenance	32
9.3 Basic maintenance procedures	32
9.4 Replacing worn parts	33
9.5 Commonly reported problems	33
<u>Chemical Compatibility Table</u>	34
WARRANTY CONDITIONS	35
Dimensions	36
Connection and exploded views	37

1.0 GENERAL COMMENTS

1.1 Warnings

The aim of HC999 pump manual is to provide you with all the necessary information for a proper installation and maintenance in order to give you optimum results whilst in operation.

For this reason it is really important reading with attention the instructions given below since they furnish all the indications necessary for the sureness of the installation, use and maintenance



- ◆ This manual has to be preserved with care to be consulted in whatever occasion.
- ◆ At the moment of the receipt you have to check the integrity of the panel and of all its components, in case of anomalies consult skilled staff before making interventions.
- ◆ Before the installation of the pump check that all the data on the pump's label correspond to those of the electrical plant.
- ◆ Do not operate with bare/naked hands or feet
- ◆ Do not leave the equipment exposed to the action of the atmospheric agents.
- ◆ Avoid splashing water
- ◆ The equipment has to be operated from skilled person.
- ◆ In case of improper functioning of the panel switch off and contact our technical assistance for any necessary repairs.
- ◆ For a correct functioning it is necessary to use original spare parts and original accessories. The producer declines whatever responsibility in reference with break down due to tampering or the use of not original spare parts and accessories.
- ◆ The electrical plant has to be in conformity with the rules of the country where it is realised.
- ◆ The room temperature of utilisation can't over take 45° C

1.2 Shipping and transporting the pump

The equipment must be transported in its original packaging, organized and built in such a way as to minimize shocks and to protect the protruding parts that can be damaged. If there is a need for transport after the equipment has already been installed (e.g. for a return for repair or replacement), reuse the original packaging or a sufficiently sturdy packaging with the equipment protected with absorbent material (eg bubble wrap). The external packaging must be such as to ensure the safety of the equipment in the event of a fall from 1 meter in height.

1.3 Use of the pump

The use of this pump must comply with the methods and instructions set out in this manual. The pump can dose chemicals that can be harmful to human health and for this reason it is essential that must be used by qualified personnel who adopt the appropriate safety methods and personal protective equipment.

AVOID IMPROPER USE of the equipment in order to avoid damage to things and people, due to uncontrolled splashes, drips, electrical contacts, etc.

The following uses can be considered improper uses, in indicative and non-exhaustive form:

- Dosing of products not consistent with the materials with which the pump is made;
- Dosing of explosive and / or flammable products;
- Dosing of fluids with excessive viscosity (1000 cps), such as to prevent the priming of the pump itself;

- Dosage of food liquids, if intended to maintain such use;
- Avoid inverting the pump delivery and suction;
- Avoid powering the pump with voltages other than those indicated in the technical specifications;
- Avoid connecting any equipment other than specific equipment to the signal outputs (level, pulse counter, current signal, etc.);

1.4 Design standard

Our pumps are built according to the actual general directives endowed with CE mark in conformity with the following European directives:

- n° 2014/30/CE “Electromagnetic compatibility – ECM”
- n° 2014/35/CE “DBT Low Voltage Directive” e s.m.i.
- n° 2011/65/UE , 2012/19/UE “direttive RoHs e WEEE” e s.m.i.

Granted this we think that in order to obtain an high trustworthiness and a lasting functioning of the pump it is necessary to follow with attention our manual particularly in reference with the maintenance!

The Producer declines all responsibility in reference with whatever intervention on the equipment from not skilled personnel!

2.0 INTRODUCTION

The HC999 pump is a metering solenoid pump that can work in constant or proportional by an external signal. In the bottom of the enclosure there are located an ON/OFF switch and an internal terminal block to connect the different signals (level probe input, water meter input, flow sensor input, 4÷20mA input and relay output)

Once the pumps is switched on the display show an user menu and is possible to read some information regarding the functioning mode and the possibility to pause and prime the pump. Thanks to the digital technology with the microcontroller and an LCD display the HC999 pump is easy to program and to save all the statistics.

3.0 TECHNICAL CHARACTERISTICS

3.1 General rules

Install the pump:



- ◆ On an horizontal reinforcement (ex: stoking tank) or on the pump shelf (optional) so that the pump head stays always in vertical position +/-15°.
- ◆ Far from an hot source in dry places at maximum temperature of 45°C and minimum 0°C.
- ◆ In a ventilated place and easily accessible by an operator for periodical maintenance.
- ◆ At a suitable height above the chemical up to a maximum height of 1.5 meters. If for exigency of the plant it's necessary to install the pump under the level of the chemical, you need to use an injection valve or an anti siphon valve.
- ◆ Do not install the pump over the tank in presence of liquids that emanate fumes unless it is hermetically closed.

ENGLISH

3.2 Standard accessories supplied

- ◆ 1 Foot valve / Strainer.
- ◆ 1 Injection fitting / pressure loading valve.
- ◆ 2 meters opaque PE delivery tubing.
- ◆ 2 meters PVC clear suction tubing.
- ◆ 2 meters PVC clear priming tubing

3.3 Electrical Characteristics

Power supply: 230 VAC 50/60 HZ

3.4 Hydraulic Characteristics

MODEL	Max flow rate @ Max pressure		Strokes Frequency (max)	Volume per stroke	Consumption (max)	Size tubing	Head pump connections
	<i>L/h</i>	<i>bar</i>	<i>per min.</i>	<i>ml / stroke</i>	<i>watt</i>	<i>mm</i>	<i>model</i>
HC999 - 3	20	5	150	2,22	35	4x6/6x 9	½" – PP
	25	3	150	2,78	35	4x6/6x 9	½" – PP
	35	1	150	3,89	35	4x6/6x 9	½" – PP
HC999 - 4	35	2	150	3,89	35	10X14	½" – PVC
	45	1	150	5	35	10X14	½" – PVC
	50	0,5	150	5,56	35	10X14	½" – PVC

3.5 Electrical connection

CAUTION !!!!!



Verify that the earth system is perfectly functional and complies with the applicable regulations. Ensure the unit is connected to a circuit protected by a highly sensitive (0.03A) RCCB circuit breaker. If unsure please consult a competent electrician. Verify that the rated values of the pump are compatible with those of the mains. Never install the pump directly in parallel with inductive loads (e.g. motors/solenoid valves) if necessary, use an isolating relay. There are 2 protection devices inside the pump: a varistor and a fuse.

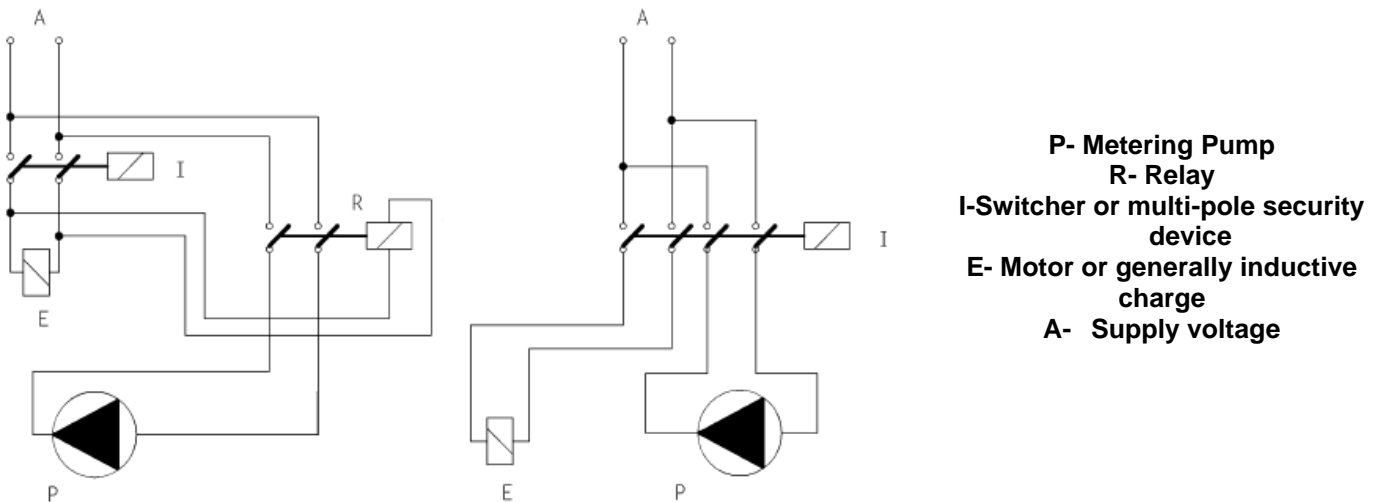

3.6 Hydraulic connection

After the exact installation of the pump (see generalities), proceed with the connection.

Suction: connect the suction tube (PVC soft cristal) to the foot filter that is supplied and put it in the hose clamp, lock the tube closing the nut. If it utilises a level probe, this one has to be connected to the filter through the support that is supplied. Put the foot filter into the liquid suction lift tank. Connect the other extremity to the suction of the pump (lower part of the pump head), unscrew the nut from the nipple, take off the rubber white disk situated on the tube connection. Let pass the tube through the nut and the adaptor for the 4x6 tube with a simultaneous action of pressing and rotating, put the tube on the nipple conical connection (hose clamp) till the end; lock up everything by closing the nuts well. See fig. 9

Delivery: connect the pump to the plant always through the injection valve (1/2"Gm) that is supplied with the installation Kit. Fit a Gf 1/2" nipple on your water supply line and after that fitting, to the point where you require chemical injection, the injection valve out with teflon and put in into the pipe. Unscrew the nut, put well the discharge tube (stiff Polyetilene) on the hose clamp of the nipple's valve, lock everything by closing the nut well. Connect the other extremity to the delivery of the pump (upper part of the pump head), by repeating the instructions above. See fig. 9

Purge: connect another tube's extremity for the manual purge (2 mt PVC crystal) in the hose clamp situated on the pump head lower to the right, while the other extremity is to be put into the suction lift tank. See fig. 10

ENGLISH

INSTRUCTION FOR PRIMING

For the priming of the pump in case of high against pressure in the injection, turn the purge knob for a quarter or a half of round (see fig. 10) until the head pump is completely full. Screw down again the knob.

ATTENTION!!



If it is necessary to take the pump off the plant, it is important to put the white disk in again, so as to avoid any exit of the liquid contained in the pump head from dripping out. - During the installation ensure that the discharge tubing is fixed correctly to avoid that it does not rub against hard bodies. Avoid also use less bends both on discharge and suction tubing.
- Connect the pump to the plant always through the injection valve (1/2" Gm) supplied with the installation kit.
- Connect the soft PVC tubing only in suction (on the foot filter side), instead connect the PE tubing in delivery by verifying that the cut of the tubing is clean and that lateral crushing is not caused; it is advisable to utilise a cutter instead of scissors.

3.7 Operation

The metering pump is activated by a Teflon diaphragm mounted on a piston enclosed into a electromagnet, which is fed by continuous current producing a square wave moving the piston thus, a pressure is produced in the pump body with an expulsion of liquid from the discharge valve. Once the electric impulse is over, the return of the piston is spring assisted thus producing the suction action to the initial position, with a recall of liquid through the suction valve. The material used for the construction of the pump makes it particularly suitable for aggressive liquids. We suggest you in any case to use the compatibility tables or our technical department.

Dimensions

Series HC999 pump - wall mounting (Fig. 1)

Series HC999 pump - base mounting (Fig.2)

Connection and exploded views

Tubing connections on pump head (Fig. 3)

Manual purge (Fig. 4)

Low level switch connection (HC999) (Fig. 6)

HC999 series description (Fig. 7)

HC999 Pump head ball (Fig. 8 - Fig. 9)

4.0 FUNCTIONING FEATURES

Constant

The pumps can work in four constant modes:

1. Capacity

When powered, the pump doses in constant mode at the selected frequency.

2. Period

When powered, the pump doses in constant mode at the selected frequency and for "X" amount of time (sec. or min.) set. (ex: 10 sec at 90% frequency rate)

Quantity to dose

When powered the pump doses a fixed amount of product at the set time (ex. 20 ml. in 10 min.), then pump stops. This cycle is repeated every time the pump is powered.

3. Cyclical

When powered the pump works in a time/cycle mode;

Proportional 1xN

The pump for each pulse received on the "**INPUT PULSE**" will perform "N" strokes at the set frequency.

Proportional 1xN (M)

The pump for each pulse received on the "**INPUT PULSE**" will perform "N" strokes and can save the extra strokes.

This mode can be programmed as follows:

1. Proportional: 1xN (M) Prop.

the pump save the extra strokes and perform them at the end of the current dosing at a proportional frequency span on the time of the last two pulses received from the water meter.

2. Instantaneous: 1xN (M) Ist.

The pump gives instantly the remaining strokes at the set frequency and the extra strokes at the proportional frequency span on the time of the last two pulses received from the water meter.

Proportional 1:N

The pump performs 1 stroke every "N" pulses received by the water meter on the "**INPUT PULSE**"

PPM

The pump calculates automatically the strokes to inject for each pulse received from the water meter.

Proportional in current – mA

The pump doses proportionally to a 4-20 mA signal received on the "**INPUT mA**".

Proportional in Cl- J (A – J Probe)

The pump doses proportionally by Chlorine reading (range 0,01- 5,00 ppm) on Chlorine A- J probe input.

Timer

The pump can be controlled by a daily or weekly timer and it's possible to program up to 7 ON/OFF operations per day.

4.1 OTHER FUNCTIONING FEATURES

Level alarm

The pump goes in low level alarm when on the "**INPUT LEVEL**" there is a dry contact (ON/OFF). This alarm has a filter of 5 seconds.

ENGLISH

Flow alarm

The pump goes on flow alarm when there is a OFF contact (flow mode) or when it doesn't receive a certain number pulses (impulses mode) on the flow input sensor.
If the alarm is programmed in flow mode, it will have a filter of 5 seconds.

Buzzer

It's possible to enable or disable the internal buzzer.

Relay setting

It's possible to set the output relay alarm "**OUT RELAY**" as Open with the alarm or Close with the alarm.

Language

It's possible to choose the pump's language among *Italian – English – French – Spanish – German*.

Clock and data

It's possible to set the clock and the data.

Statistics

It's possible to read the statistics of the pump as the number of strokes total and partial and the quantity of dosed chemical total and partial.

Restore default parameters

This function allows to restore the default parameters.

Units of measurement

This function allows to set the units of measurement of the pump's flow rate.

%: in percentage of maximum flow rate

SPM: strokes per minute

L/H: litres per hour – only after the calibration

ml/min: ml per minute – only after the calibration

Adjust the display contrast

This functions allows to adjust the contrast of the LCD display.

4.2 USER INTERFACE

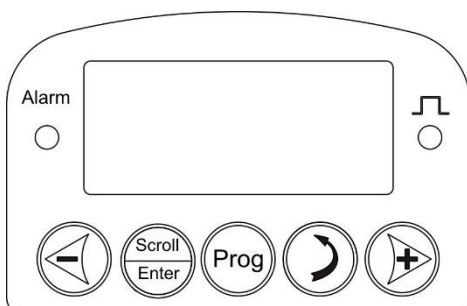

- Back light 2x12 LCD
- Red L.E.D. for alarm
- Green L.E.D. for stroke's pump
- 5 keys

4.3 POWER SUPPLY





⚠ CAUTION: Always disconnect power when servicing the unit.

The pump is supplied, as standard, with a three-pole power cable, but without a plug. Connect the cable to a suitable 230 Vac 50/60 Hz power supply, which can be with plug or with direct connection to the electrical panel.

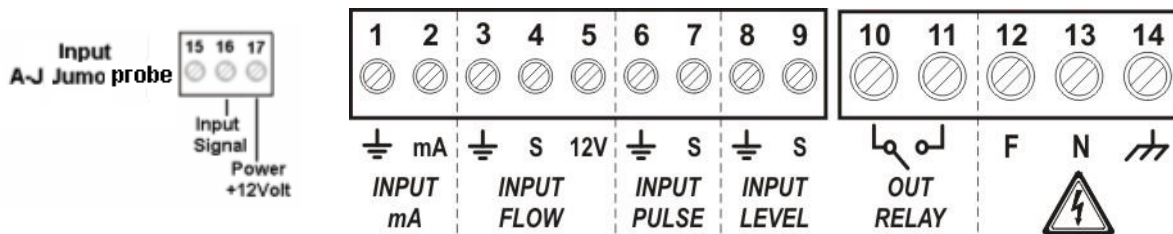
If it is necessary to replace the power cable, this must be done by specialized personnel. Open the pump by removing the 4 screws located on the down of the case and connect the cable, through the cable gland, exactly like the existing cable, using cable H05VV-F 3x0.75 mm². Close the pump after connection.

Inside the pump there is a terminal block for connecting the accessories not supplied, which must be connected, by specialized personnel, according to the indications of the following diagram:



INPUT	PINS	DESCRIPTION	WHAT CONNECT
INPUT mA	1-2	Input to connect a 0÷20mA current signal that comes from a controller.	
INPUT FLOW	3-4-5	Input to connect a flow sensor.	
INPUT PULSE	6-7	Input to connect a water meter.	
INPUT LEVEL	8-9	Input to connect a level probe.	
INPUT CHLORINE JUMO	16-17	Input to connect a chlorine A- J probe.	

5.0 USER MENU

Once the pumps is switched on the display show an user menu and is possible to read some information regarding the functioning mode and the possibility to pause and prime the pump.

Moreover from the standby menu is possible to enter in the user menu to perform some functions.

5.1 PAUSE THE PUMP

From the standby menu press the  key, the display will show:

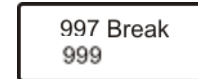

Press twice the  key to go back at the standby menu.

5.2 PRIMING THE PUMP

From the standby menu press twice the  key, the display will show:

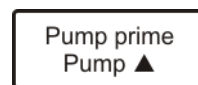

Keep pressed the  key to activate the pump.

Press the  key to go back at the standby menu

3.3 ADJUSTING THE CHLORINE SETPOINT

From the standby menu press three timer the  key, the display will show the current setpoint.

Press the   keys to set the desired values ant then the  key to confirm.

Press twice the  key to go back at the standby menu.





 After 10 seconds the pump automatically goes back to the standby menu if no key is pressed.

6.0 PROGRAMMING

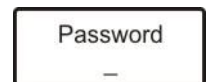
6.1 ENTER IN PROGRAMMING MODE

From the user menu, keep pressed the  key for three seconds, the display will show:



To enter press the following key's combination:    

6.2 PROGRAMMING MENU

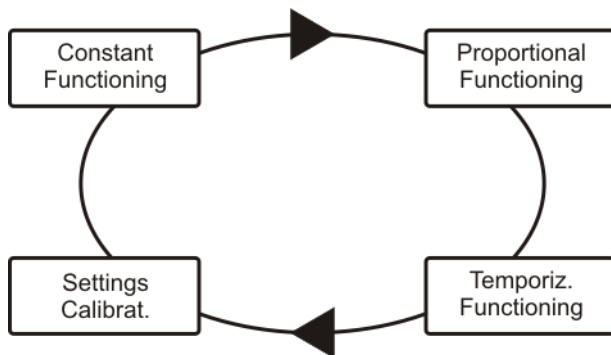

With the   keys is possible scroll the menu's choices.

To select the desired choice press  key

***ATTENTION: TO CONFIRM AND SAVE THE PROGRAMMING PRESS THE BUTTON**  **FOR 5 SECONDS.**

6.2.1 PROGRAMMING MENU DESCRIPTION

Constant functioning menu

It allows to select among the following functioning modes:

Capacity – Period – Quantity to dose – Cyclical

Proportional functioning menu

It allows to select the following functioning modes:

- proportional by external pulses from a water meter 1:N mode
- proportional by external pulses from a water meter 1xN mode
- proportional by external pulses from a water meter 1xN mode with memory
- proportional by external 4÷20 mA current signal
- PPM
- Proportional by pH
- Proportional by Rx

Timer functioning menu

It allows to programming the pump in daily or weekly timer mode.

Setting menu – Calibration

This menu allows to set all the functioning parameters of the pump and moreover to calibrate the pump.

6.3 PROGRAMMING MENU – CONSTANT FUNCTIONING

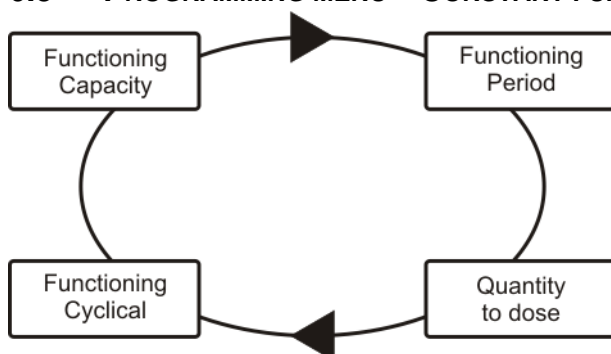



Press the   keys to scroll the entries of the menu.

Press the  key to choice the entry desired.

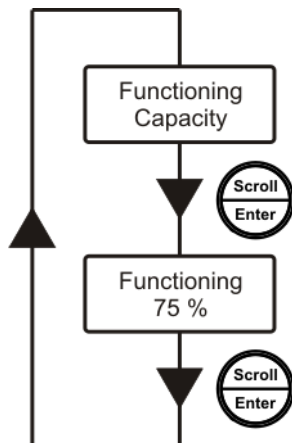
6.3.1 Functioning Capacity



The pump doses at a constant flow rate set in different unit of measurements (% , SPM, ml/min, L/h) – see the setting menu. When the pump is powered, it performs a continuous dosing at the programmed flow rate.

Press the   keys to set the desired values.

Press the  key to go at the previous menu.

6.3.2 Functioning Period

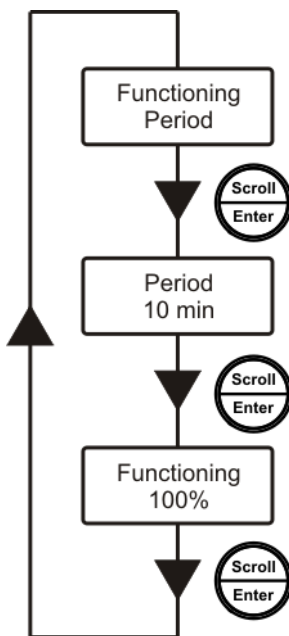



The pump doses for programmed time and flow rate.

In this functioning mode there are two parameter to set:

- Period (working time)
Setting from 1 to 240 minutes at steps of 1 minute.
- Functioning that can be in different units of measurement (% , SPM, ml/min, L/h) – see the settings menu.

Example: Period = 10 minutes Functioning = 100%
The pump doses per 10 minutes at the 100% of the maximum flow rate.

Press the   keys to set the desired values.

Press the  key to go at the previous menu.

6.3.3 Quantity to dose

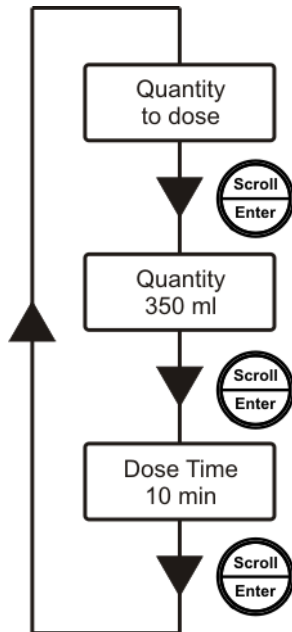



The pump doses a desired quantity in the programmed time.

In this functioning mode there are two parameter to set:

- The quantity of the chemical to dose.
Setting from 1 to 2000 ml at steps of 1 ml.
- Dose time.
Setting from 1 to 240 minutes at steps of 1 minute.

*Example: Quantity = 350 ml Dose Time = 10 minutes.
The pump doses 350ml in 10 minutes.*

Press the   keys to set the desired values.

Press the  key to go at the previous menu.

 **Perform the calibration of the pump before to use this functioning mode.**

The pump automatically calculate the minimum dosing time after set the quantity.

6.3.4 Functioning Cyclical

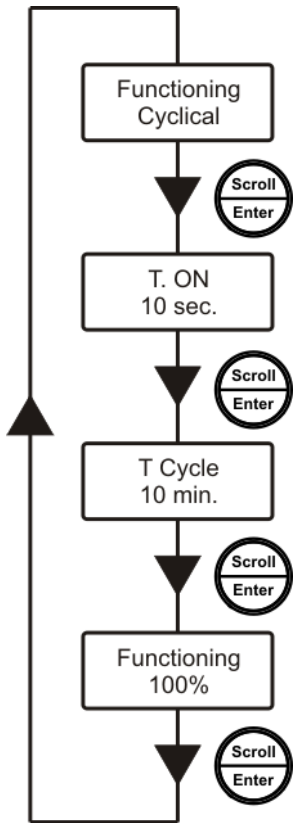

When the pump is powered, it perform a dosing at the set flow rate for a programmed time (T_{ON}) every cycle time (T_{Cycle}).

In this functioning mode there are three parameters to set:

- T_{ON} (working time).
Setting from 0 to 90 minutes at steps of 1 second.
- T_{Cycle} (cycle time)
Setting from 0 to 24 hours at steps of 1 hour.
- Functioning that can be in different units of measurement (% , SPM, ml/min, L/h) – see the settings menu.

*Example $T_{ON} = 10$ seconds $T_{Cycle} = 10$ minutes Functioning = 50%
The pump doses 10 seconds every 10 minutes at the 50% of the maximum flow rate.*

Press the keys to set the desired values.

Press the key to go at the previous menu.

6.4 PROGRAMMING MENU – PROPORTIONAL FUNCTIONING

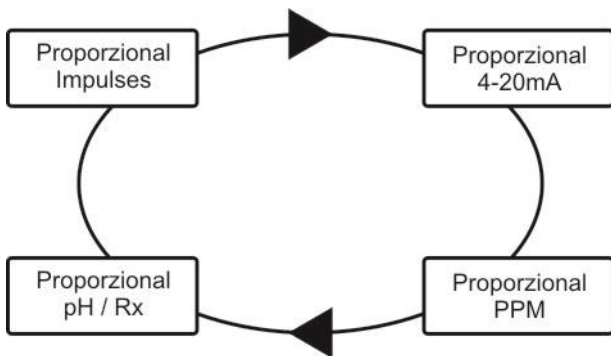

Press the keys to scroll the menu entries.

Press the key to select the desired entry.

6.4.1 Proportional functioning by external pulses

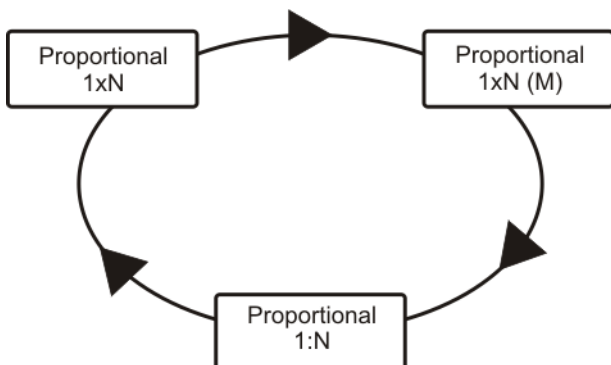

Press the keys to scroll the menu entries.

Press the key to select the desired entry.

6.4.2 Proportional functioning by external pulses 1xN

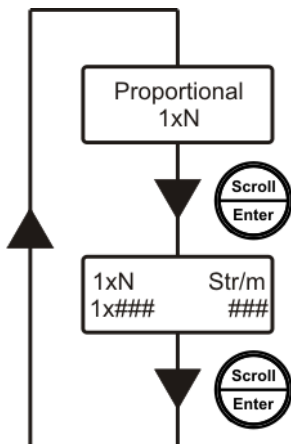

In this functioning mode there are two parameters to set:

- Number of strokes to perform.
Setting from 0 to 250.
- Frequency of the strokes per minute (Str/m).
Setting from 1 to 150 or 180 (depends on the model).

Every time the pump receives a pulse from the water meter it perform the desired strokes at the programmed frequency.

Example 1xN = 1x15 Str/m = 60

The pumps gives 15 strokes at 60SPM frequency every time it receives a pulse from the water meter.

Press the keys to set the desired values.

Press the key to go at the previous menu.

6.4.3 Proportional functioning by external pulses 1xN (M)

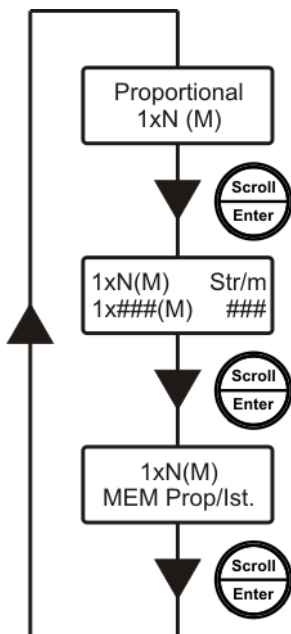

Every time the pump receives a pulse from the water meter it perform the desired strokes at the programmed frequency.

If the pump receives pulses from the water meter when it's performing a dosing the pump manages this situation in two modes: **proportional** or **instantaneous**.

Instantaneous, the pump gives instantly the remaining strokes at the set frequency and the extra strokes at the proportional frequency spans on the time of the last two pulses received from the water meter.

Proportional, the pump save the extra strokes and perform them at the end of the current dosing at proportional frequency spans on the time of the last two pulses received from the water meter.

In this functioning mode there are three parameters to set:

- Number of strokes to perform.
Setting from 0 to250.
- Frequency of the strokes per minute (SPM).
Setting from 1 to 150 or 180 (depends on the model).
- Type of memory proportional or instantaneous.

Example: 1xN (M) = 1x15 Bat/m = 60

The pumps gives 15 strokes at 60SPM frequency every time it receives a pulse from the water meter.

Press the keys to set the desired values.

Press the key to go back at the previous menu.

6.4.4 Proportional functioning by external pulses 1:N

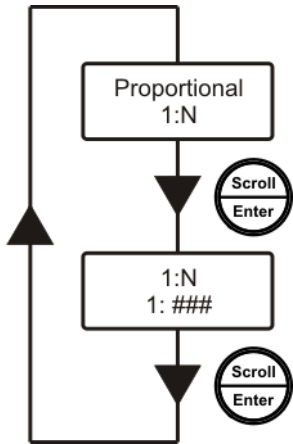

Every time that the pump receive “N” pulses from the water meter, the pump performs a stroke.

In this functioning mode there is only one parameter to set:

- Number of strokes to divide (N).
Setting from 0 to 250.

Example: 1:N = 1:15

The pump performs a stroke every 15 pulses received from the water meter.

Press the keys to set the desired values.

Press the key to go back at the previous menu.

6.4.5 Proportional functioning in 4-20mA current signal

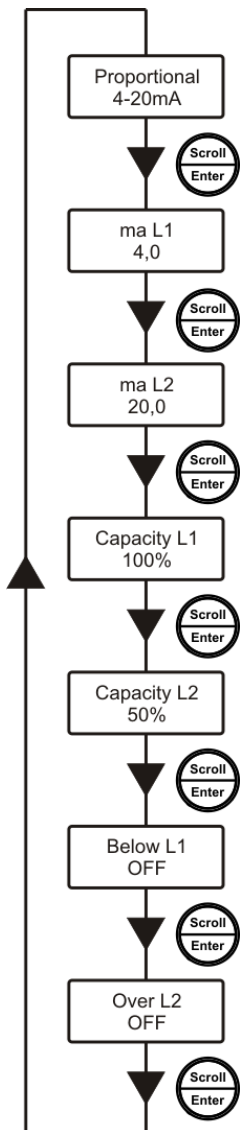

The pump performs a dosing proportional at the current value on its input.

In this functioning mode there are seven parameters to set:

- Lower limit L1
Setting from 0 to 20mA at steps of 0,1mA.
- Upper limit L2
Setting from 0 to 20mA at steps of 0,1mA.
- Capacity L1
Setting from 0 to 100%.
- Capacity L2
Setting from 0 to 100%.
- Below L1
Setting OFF or ON.
- Over L2
Setting OFF or ON.

Example: L1=4mA L2 = 12mA Capacity L1 = 10% Capacity L2 = 50%
Below L1= OFF Over L2 = ON

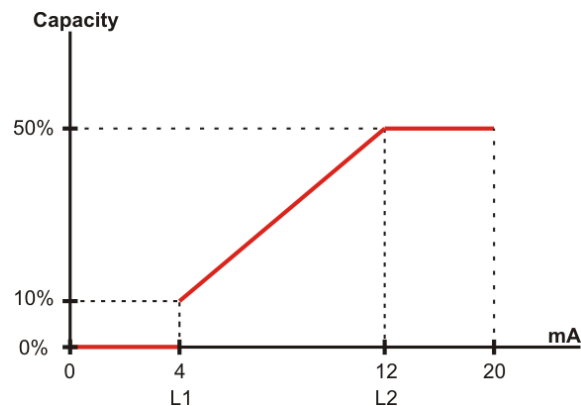

If in input there is a current of 8mA the pump performs a dosing at 30%.



Press the keys to set the desired values.

Press the key to go back at the previous menu.

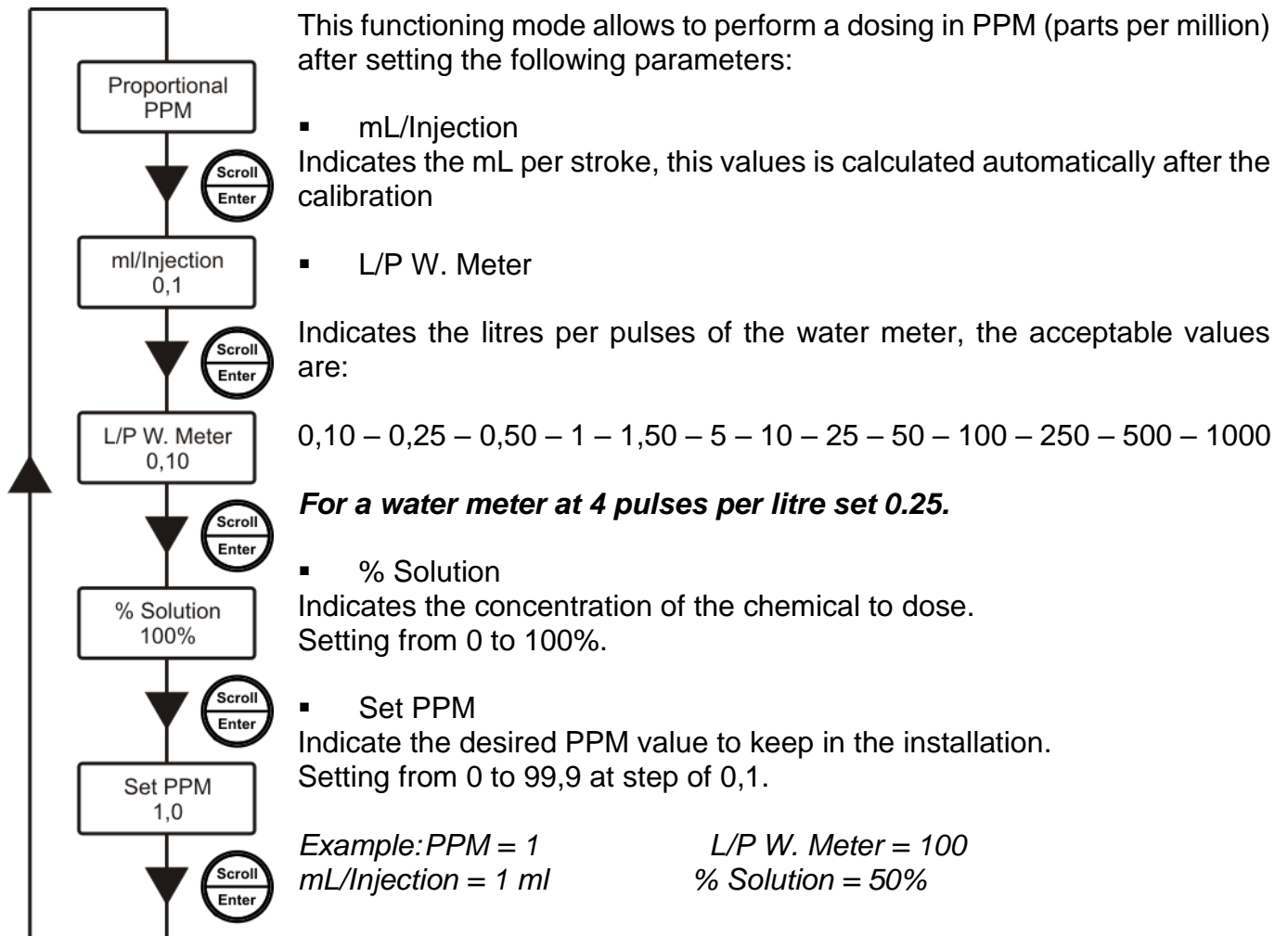
6.4.6 Proportional functioning in PPM



In this case $N=0,2$ that means that every 5 pulses from the water meter the pump performs a stroke..

Press the   keys to set the desired values.

Press the  key to go back at the previous menu.

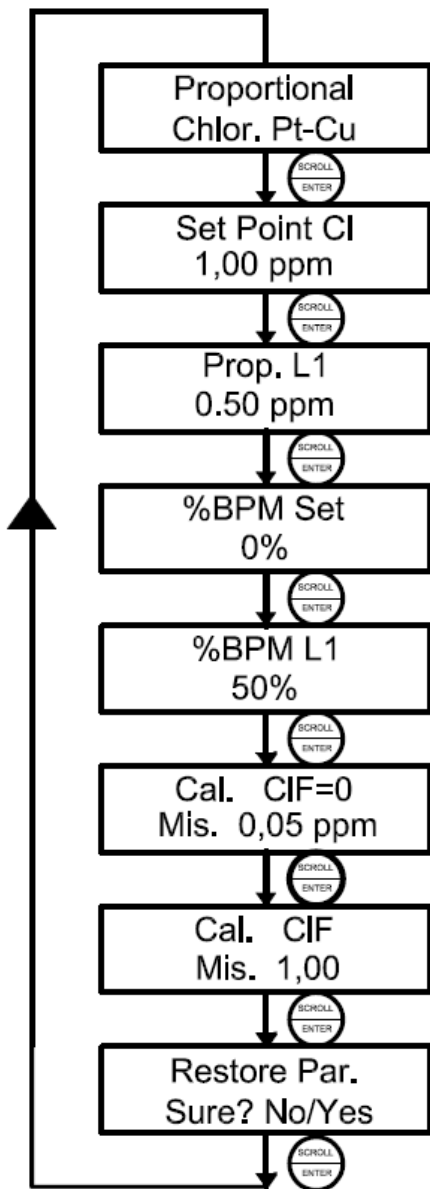

4.4.7 Functioning proportional chlorine (A – J probe)



The pump doses proportionally by chlorine A – J probe reading In this functioning, the parameters to set are the following:

- A – J ppm
Indicates the range of work Cl –J probe
Setting from 0 to 100.000 ppm.
- Set point A - J
Indicates the Cl value to maintain constant.
Setting from 0,01 to 5,00 ppm at step of 0,01.
- Prop. L1
Indicates the Cl value that together with the Setpoint value make the proportional dosing band.
Setting from 0,01 to 5.00 ppm at step of 0,01.(See par. 4.4.8).
- % SPM Set
Indicates the dosing frequency of the pump at the Setpoint value.
Setting from 0 to 100%.
- % SPM L1
Indicates the dosing frequency of the pump at the Setpoint value.
Setting from 0 to 100% (See par. 4.4.8).
- Calibration Gain
The Probe A-J don't require zero calibration, wait until the measure stabilized maintain the speed flow between 30 and 90 l / h. and measure the ppm whit DPD chlorine free test Kit.

Press the  keys to adjust the measured value.

Make corrections using the buttons  

- Restore Par.
Restoring the default parameters of the chlorine functioning.

Press the  key to go back at the previous menu.

4.4.8.1 Diagram of the proportional functioning by CL signal

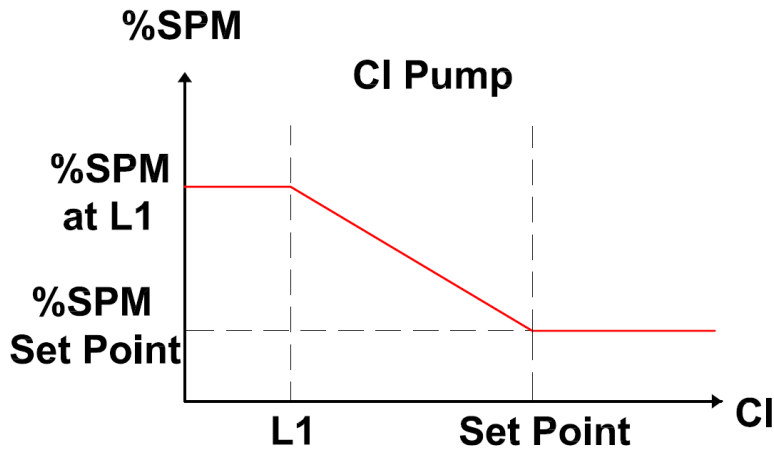

6.5 PROGRAMMING MENU - TIMER

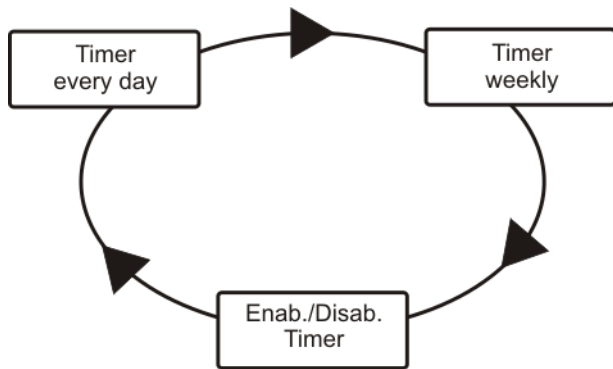

This mode allows to program the pump as a daily or weekly timer up to 7 ON/OFF operations

Press the   keys to scroll the menu entries.

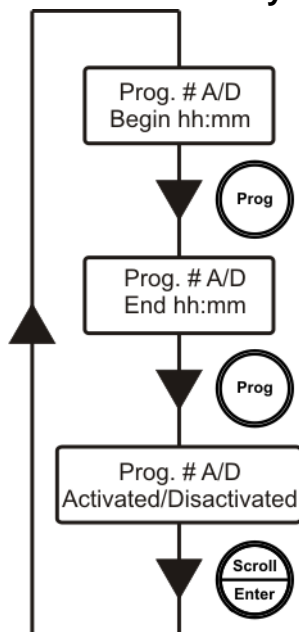

Press the  key to select the desired entry.

6.5.1 Timer every day programming



The pump can be activated every day and it is possible to set up to 7 ON/OFF operations with the start and end time. Moreover the timer can be disabled.

The minimum dosing time is 1 minute.

Press the   keys to set the desired values.

Press the  key to go back at the previous menu.



Press the  key to go at the next program.

6.5.2 Timer weekly programming

The pump can be activated weekly and it is possible to set up to 7 ON/OFF operations with the start and end time. Moreover the timer can be disabled.

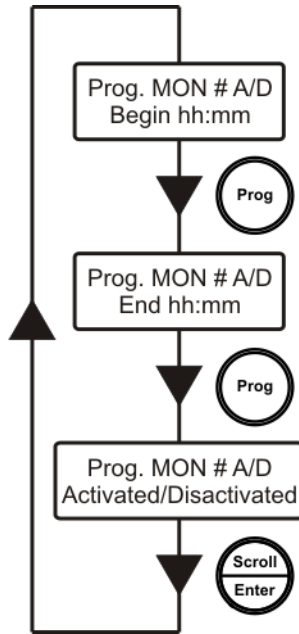
The minimum dosing time is 1 minute.





Press the   keys to set the desired values.

Press the  key to go back at the previous menu

Press the  key to go at the next program.

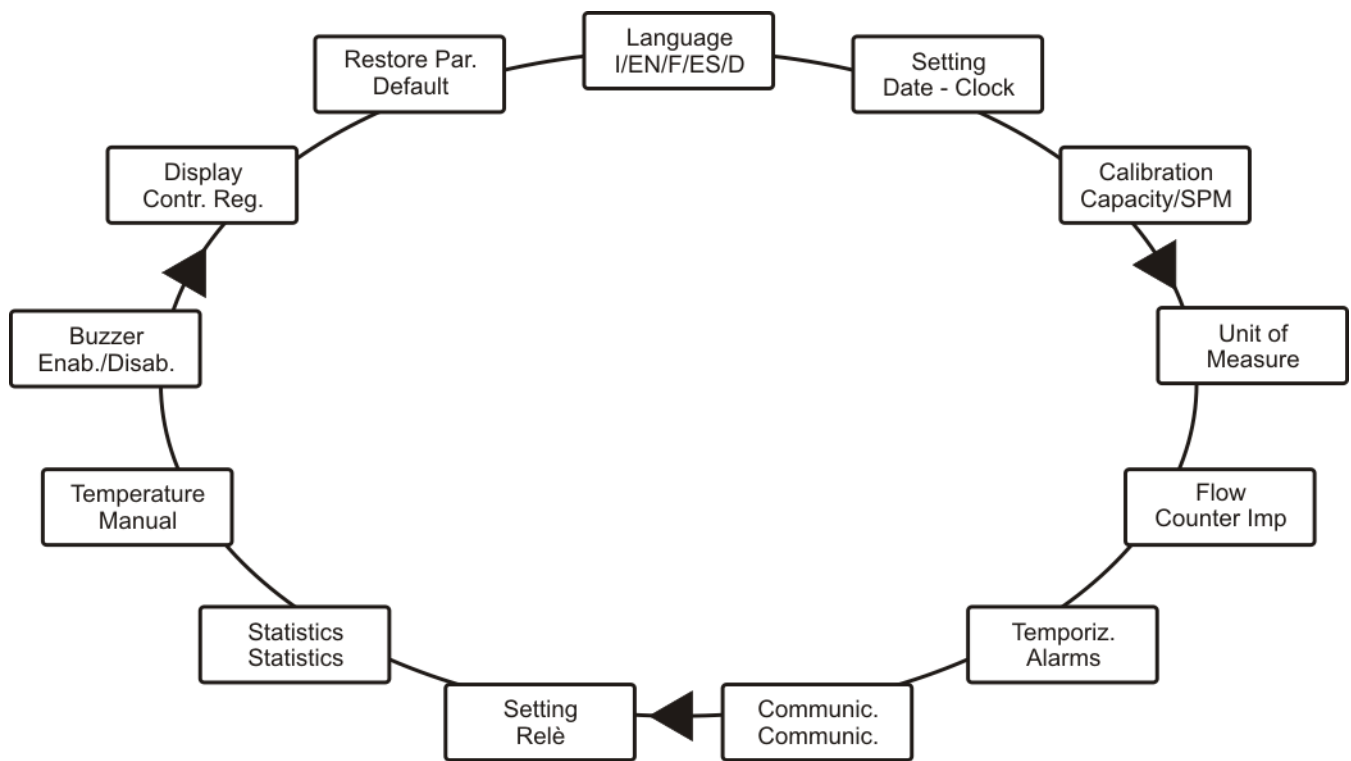
6.6 PROGRAMMING MENU – SETTINGS AND CALIBRATION





Press the   keys to scroll the menu entries.

Press the  key to select the desired entry.

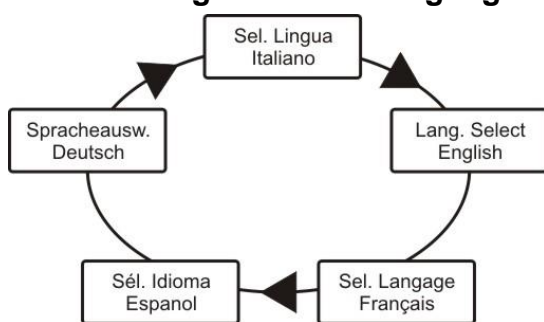
6.6.1 Settings menu – Language



This menu allows to select the programming language of the pump.

Press the   keys to scroll the menu entries.

Press the  key to select the desired entry.

6.6.2 Settings menu – Date and clock

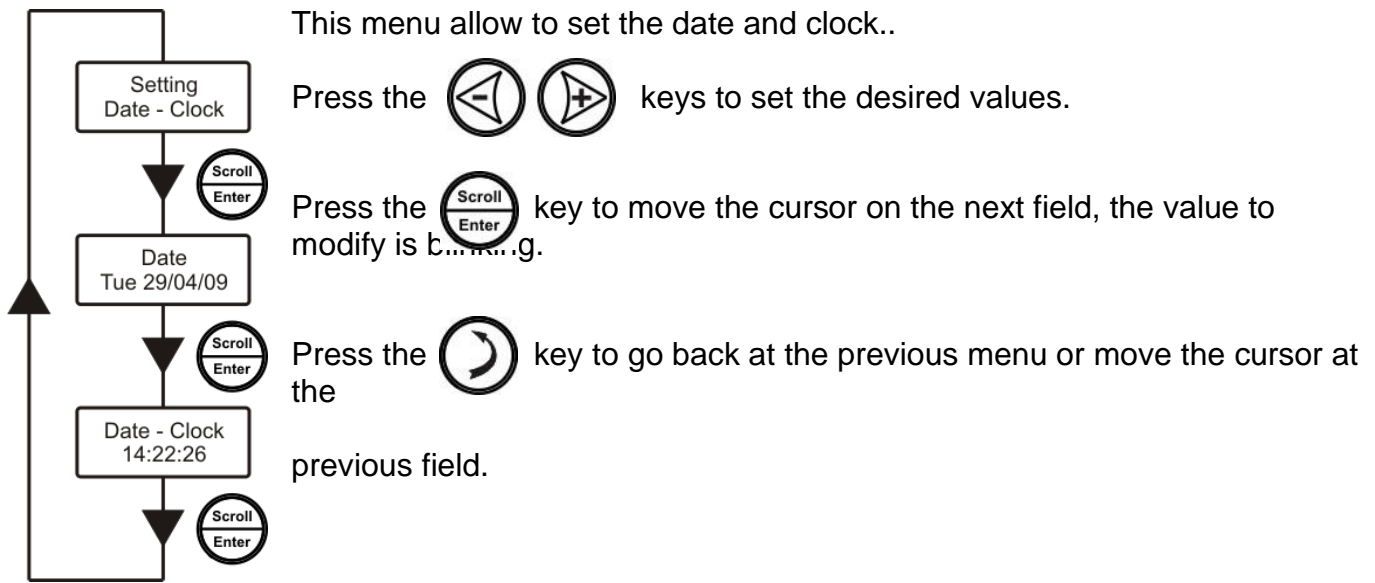

6.6.3 Settings menu – Calibration

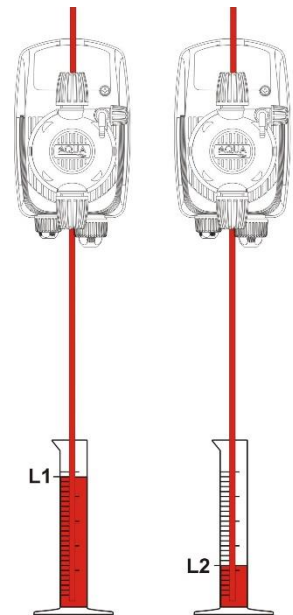
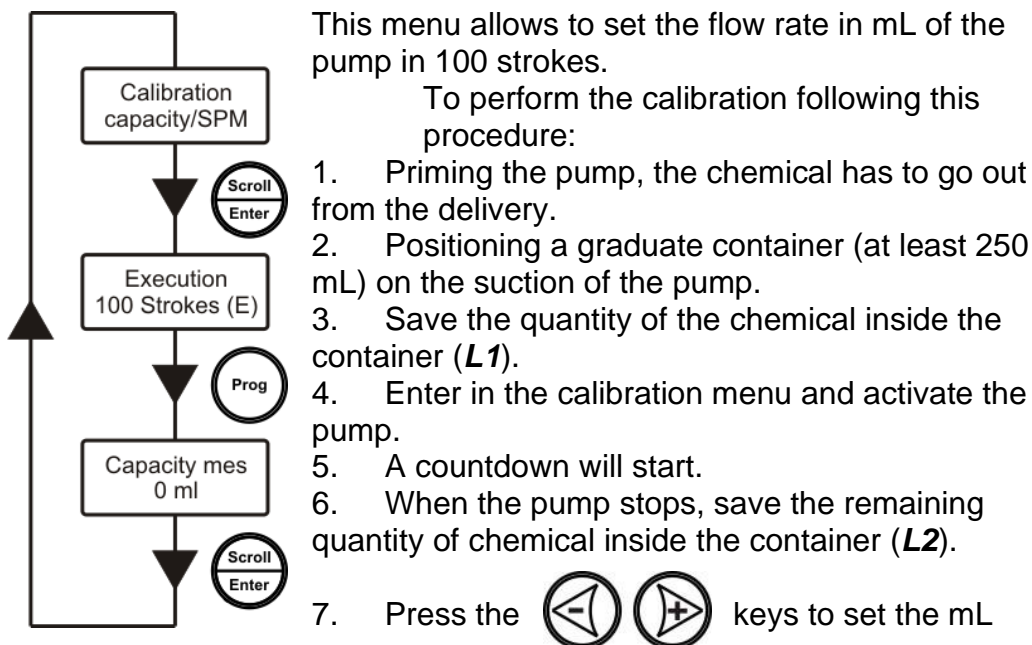

drawn that is the difference between **L1- L2** and then press the key to confirm.

6.6.4 Settings menu – Units of measurement

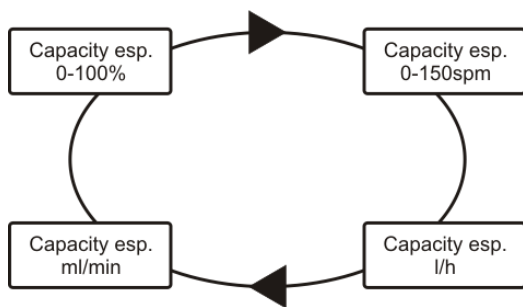

This menu allows to set the units of measurement of the pump's flow rate. The units of measure L/h e mL/min are active only after the calibration.

Press the keys to scroll the menu entries..

Press the key to select the desired entry.

6.6.5 Settings menu – Flow alarm

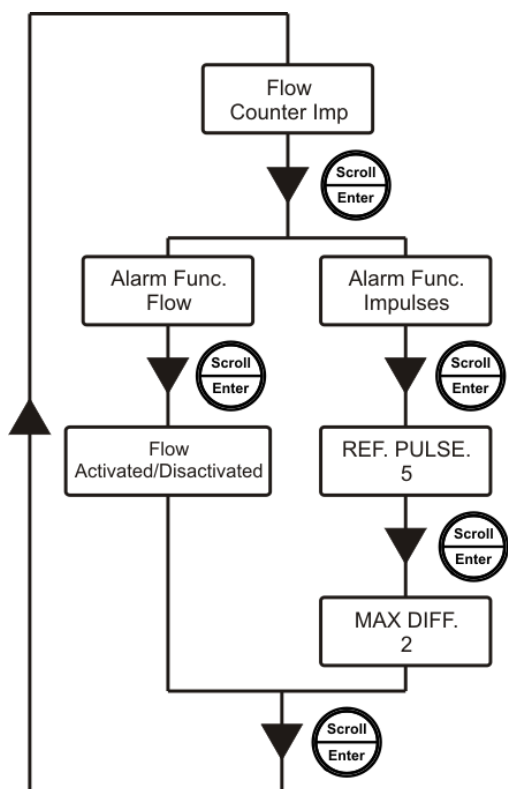

This menu allows to set the alarm function of the flow sensor.

It can be:

1. Impulses

There are two parameters to set:

- Reference pulses (REF. PULSE)
Indicates the number of pulses that the pump must receive.
Setting from 2 to 250 at steps of 1.
- Max difference (MAX DIFF.)
Indicates the maximum difference that the pump can accept between the received pulses and the reference pulses.
Setting from 1 and the value set on reference pulses at steps of 1.

2. Flow

In this case, it's possible enable or disable the alarm and the flow signal is considered as a dry contact (ON/OFF).

Press the keys to set the desired values.

Press the key to go at the previous menu.

6.6.6 Settings menu – Timing alarms

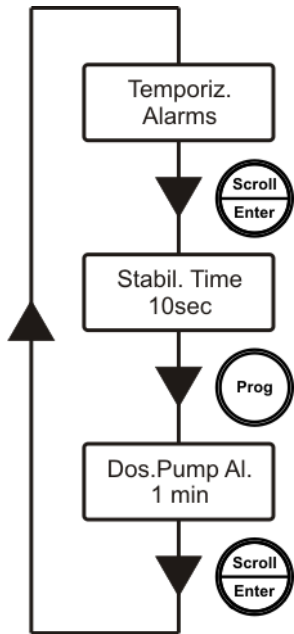



This menu allows to set some parameters to manage the alarm signals of the pump.

The parameters are the following:

- **Stabilization time**
Indicates the minimum time that an alarm signal must last before to be recognize as a valid alarm.
Setting from 1 to 59 seconds at steps of 1 second or from 1 to 60 minutes at steps of 1 minute

- **Dosing pump alarm**
Setting from 1 to 60 minutes at steps of 1 minute.



Press the   keys to set the desired values.

Press the  key to go at the previous menu.

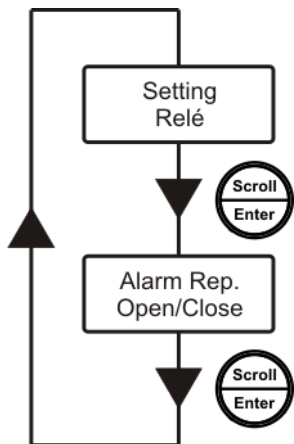
6.6.7 Settings menu – Relay output



This menu allows to set the functioning of the relay output (**OUT RELAY**) that can be normally open or normally closed.

Press the   keys to choose between Open or Close.

Press the  key to go at the previous menu.

6.6.8 Settings menu – Statistics

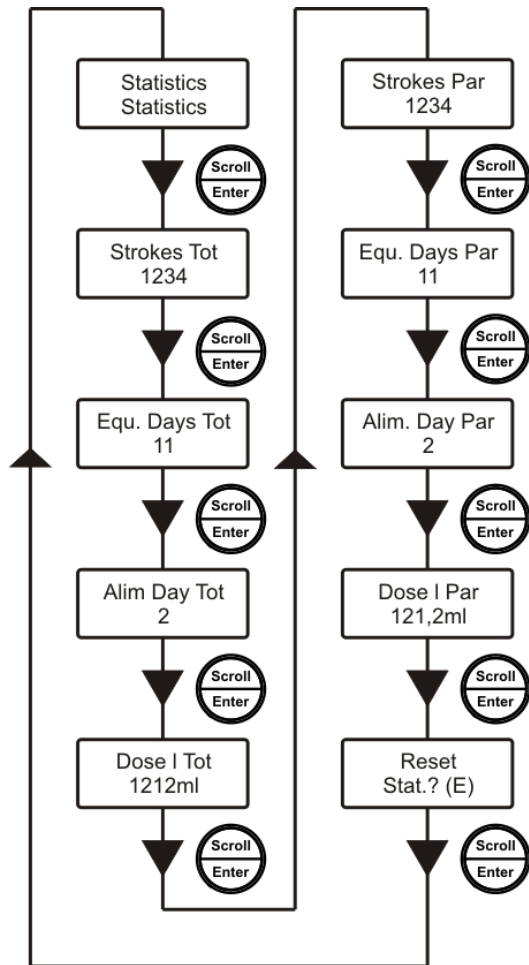

This menu allows to read the statistics: total (Tot) and partial (Par).

N. Strokes Tot

Indicates the total strokes performing by the pump.

Equ. Days Tot

Indicates the total working days of the pump.

Alim Day Tot

Indicates the total days that the pump has been powered.

Dose I Tot

Indicates the total mL dosed by the pump.

Strokes Par

Indicates the number of strokes performed by the pump since the last reset.

Equ. Days Par

Indicates the working days of the pump since the last reset.

Alim Day Par

Indicates the days that the pump has been powered

since the last reset.

Dose I Par

Indicates the mL dosed by the pump since the last reset.

The reset erase only the partial statistics.

Press the  key to go back at the previous entry or menu.

6.6.9 Settings menu – Buzzer

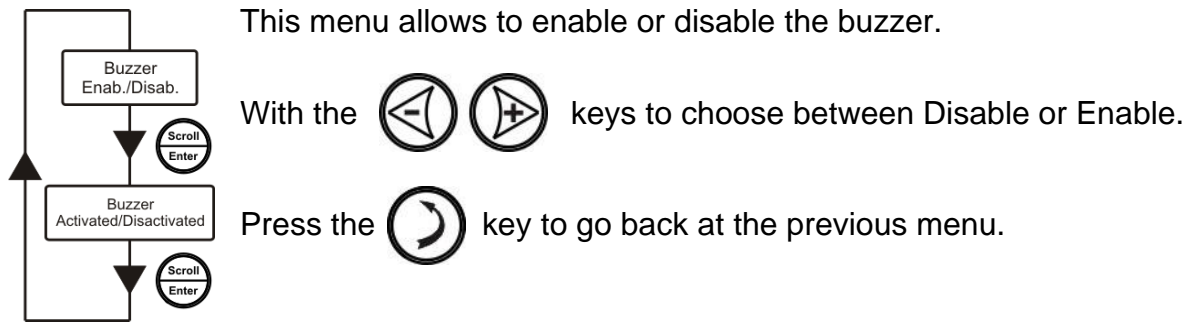

6.6.10 Settings menu – Display Contrast

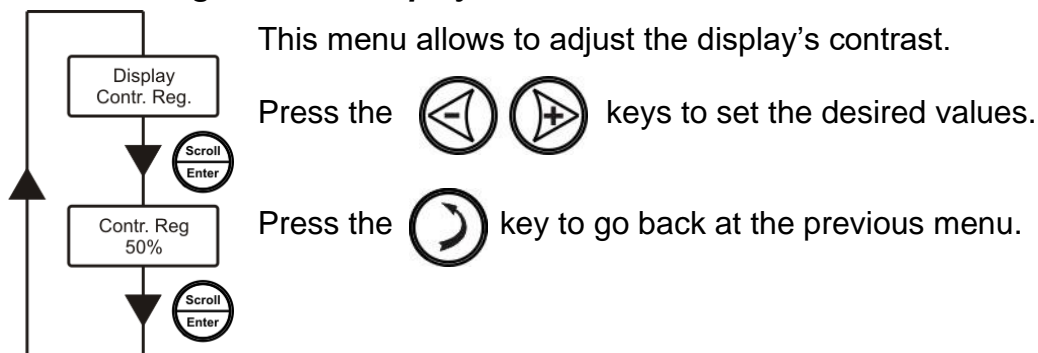

6.6.11 Setting menu – Restore default parameters

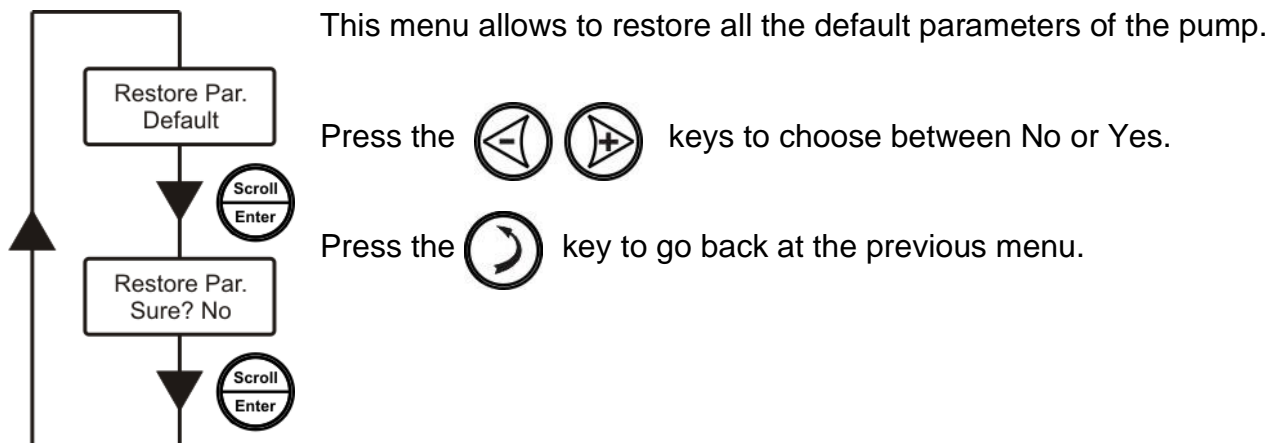

7.0 DEFAULT PARAMETERS

Functioning Capacity – Capacity	100%	Proportional CI – L1	0,50
Functioning period – Period	10 min	Proportional CI – %SPM CI=Set	0%
Functioning period – Functioning	100%	Proportional CI – %SPM CI=L1	50%
Quantity to dose – Quantity	Cal Capacity	Timer every day – Begin	12:00
Quantity to dose – Dose Time	3 min	Timer every day – End	12:00
Functioning Cyclical – T ON	10 sec	Timer weekly – Begin	12:00
Functioning Cyclical – T cycle	10 min	Timer weekly – End	12:00
Functioning Cyclical – Functioning	100%	Language	Italian
Proportional impulses 1xN – 1xN	10	Date and clock	Automatic
Proportional impulses 1xN – Str/m	90	Calibration	NA
Proportional impulses 1xN (M) – 1xN	1	Units of measure	0-100%
Proportional impulses 1xN (M) – Str/m	90	Flow counter impulses	Flow/Enable
Proportional impulses 1xN (M)	MEM Prop	Flow counter impulses – Impulses – REF. PULSE	10
Proportional impulses 1:N – 1:N	10	Flow counter pulses flow – Impulses – MAX DIFF.	10
Proportional 4-20mA – mA L1	4 mA	Temporiz. Alarms – Stabil. Time	10 sec
Proportional 4-20mA – mA L2	20 mA	Temporiz. Alarms – Dos. Pump. Al.	OFF
Proportional 4-20mA – Capacity L1	0%	Setting relè – Alarm Rep.	Open
Proportional 4-20mA – Capacity L2	50%	Statistics – Strokes Tot	NA
Proportional 4-20mA – Below L1	OFF	Statistics – Equ. Days Tot	NA
Proportional 4-20mA – Over L2	OFF	Statistics – Alim Day Tot	NA
Proportional PPM – ml/injection	0,01	Statistics – Dose I Tot	NA
Proportional PPM – L/P water meter	0.10	Statistics – Strokes Par	0
Proportional PPM – % Solution	100%	Statistics – Equ. Days Par	0
Proportional PPM – Set PPM	1,0	Statistics – Alim Day Par	0
Proportional CI – Setpoint CI	1.00		0

8.0 SIGNALS INPUT

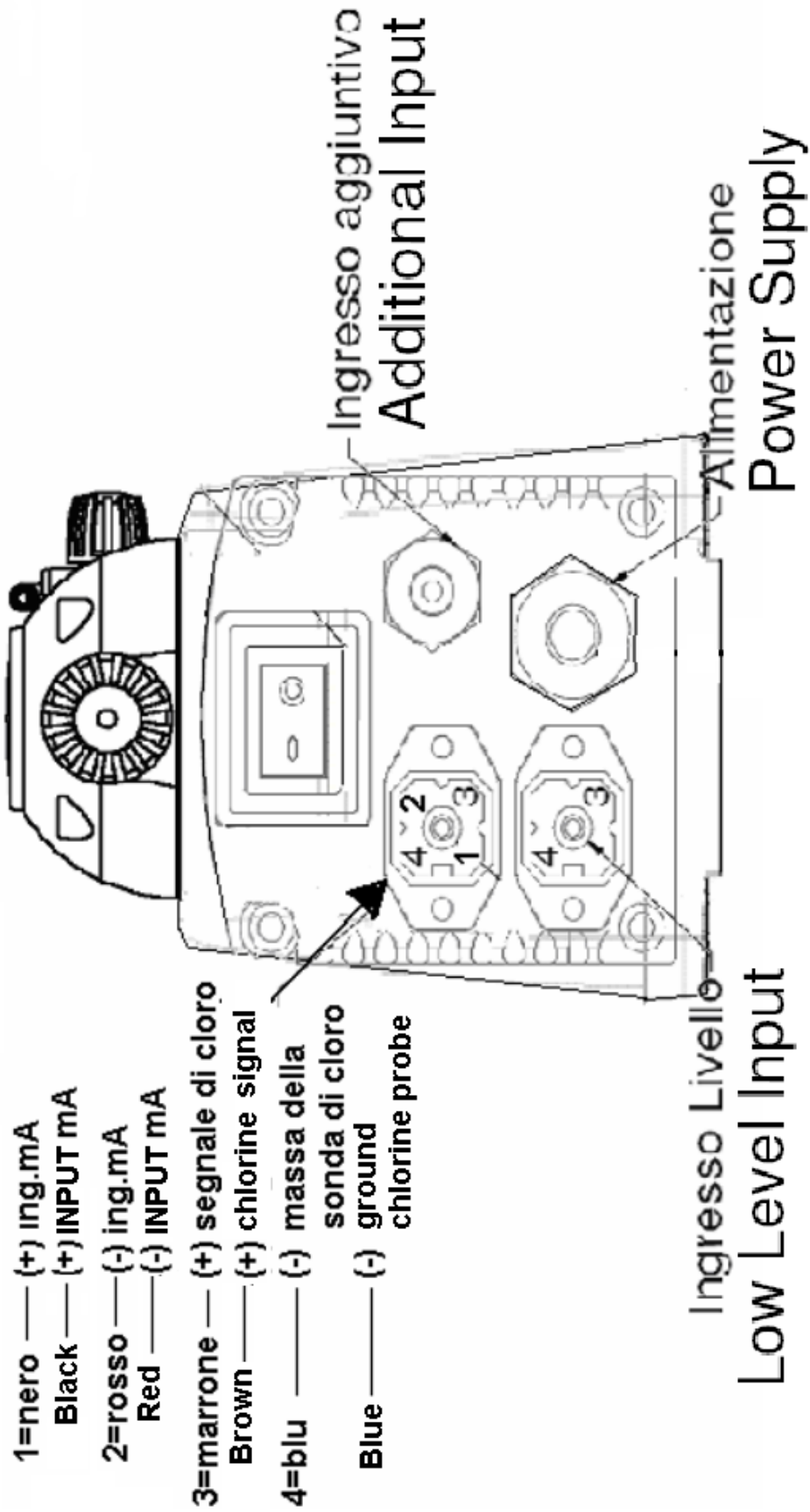

ENGLISH: Signals Input

The pulse input (signal input contact 3-4) is suitable for :

- ◆ Relè input without voltage
- ◆ Digital input Type NPN with maximum voltage < 1 V (the polarity must be respected 3 -, 4 +)

The mA input (signal input contact 1-2) must be connected with the following polarity:

1 Negative – 2 Positive

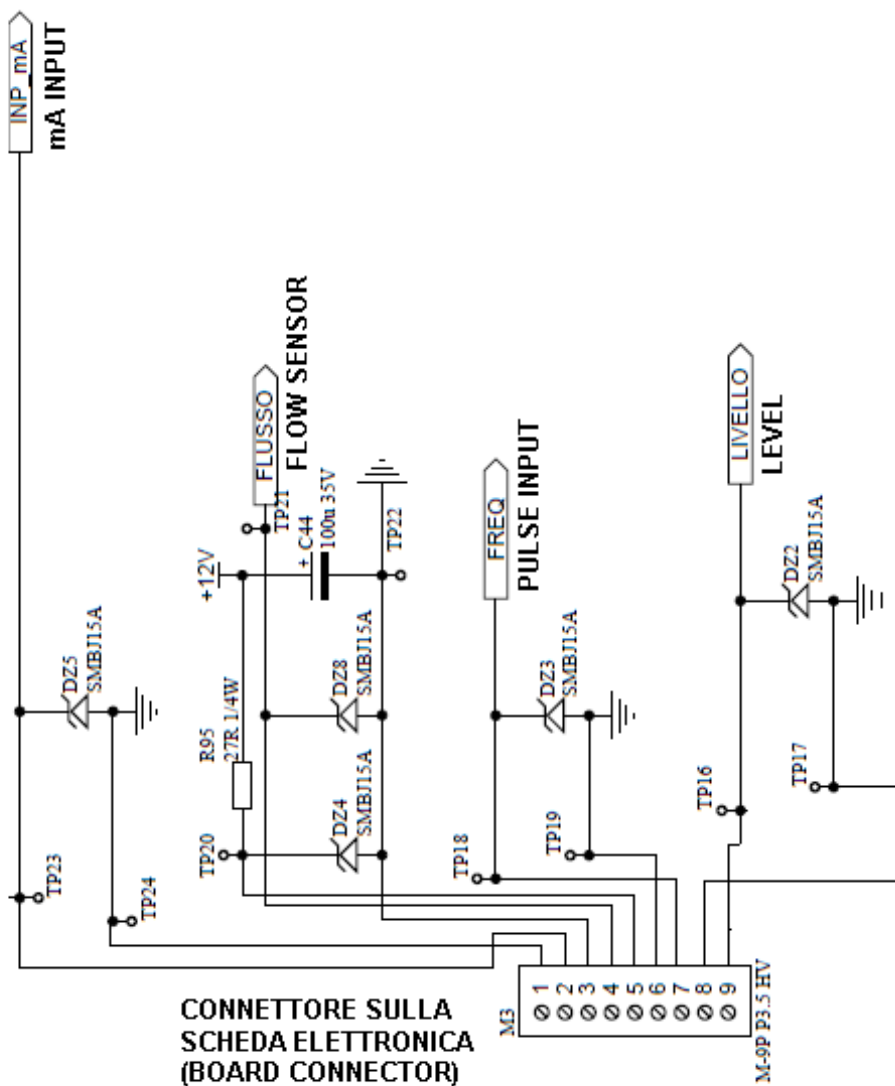

9.0 MAINTENANCE

9.1 General maintenance comments



Regular maintenance is essential if the pump has to give good service over a long period.

The following advice should be strictly followed:

It is difficult to estimate the periods between maintenance operations, because of the pumps operating conditions and the chemicals employed.

It is therefore the basic responsibility of the operator to check regularly the appearance and condition of the pump and to clean and service it according to his findings

9.2 Periodic maintenance



Liquid's level in the tank should be monitored regularly and the tank refilled a necessary to avoid the running dry of the pump. Wet parts of the pump, foot valve, suction/delivery valves and the head and diaphragm should be inspected and cleaned at least every 3 months. Where very aggressive chemicals are being dosed, (Sodium Hypo chlorite is particularly difficult) this period may need to be reduced and cleaning be carried out more frequently. If pumps are not used for long periods, scale, sediment and encrustation deposits can build up causing the pump to malfunction. We highly recommend careful maintenance of the valves by running them under clean water after long periods of non use. Alternatively, if the pump has not been used for long periods, before re-setting up the operations, we strongly recommend operating it for at least 30 minutes with the foot filter immersed in clean water to flush the pump.

9.3 Basic maintenance procedures

Before doing any maintenance read with attention the technical and safety characteristic of the dosing chemicals and follow the next procedures:

1 Turn off the pump and immerse the foot filter and the injection tube in clean water. Turn on the pump to let the water go through the pump head. If there are some crystals to be cleaned follow the next procedures:

2 Immerse the foot filter and the injection tube into an adequate solution to remove the crystals (ex. Chloridric Acid for Sodium Hypochlorite crystals); let the pump work for some minute. Then repeat the action with water and connect the pump to the plant.

ATTENTION!!!!



It's necessary to effectuate all the operations with gloves and glasses suitable for the product used then consult the supplier of the chemical product.

9.4 Replacing worn parts

Fuse replacement.

Proceed as follows:

1. Put at minimum the knob of the piston regulation of the run (in the pump where it is present)
2. Unscrew the fixing screws of the box
3. Open the front and the back part of the box minding the spring of the knob where it is present.
4. Replace the fuse that is well visible.
5. Assemble all the parts paying attention that the piston regulation knob (where it is present) is at the minimum position and that the spring is in.

Valves cleaning HC797- HC897- HC899 - HC997- HC999

Proceed as follow:

1. With a little tool extract the valve cartridges from their seats
2. Pay attention not to loose the oring at the bottom of the cartridge
3. Clean the valve cartridge with clear water
4. For a complete cleaning it is possible to open the valve cartridge, be carefull with all the internal parts
5. Assemble again the valve cartridge following drawing fig. 13-14-15-16
6. Insert again the valves cartridges in their seats

Diaphragm and O-rings replacement

Proceed as follows:

1. Undo the 4 bolts with an hexagonal key.
2. Remove the pump head.
3. Remove the old O-ring from the head carefully using a small screw driver.
4. By hand, or with pliers if necessary unscrew the diaphragm, and replace with the new one. Hand tight only. Before screwing the diaphragm into place, add a small quantity of Loctite® 222 onto the thread.
5. Refit the dosing head, tightening the head bolts sequentially and carefully to ensure an even airtight seal. Caution do not over tighten. We also recommend adding a few drops of Loctite® 222 on to the thread of the screws that hold the head.
- 6.0 Position the pump body and screw in the 4 screws, tightening them crosswise for a perfect seal, to avoid accidental unscrewing of the screws it is recommended to add a drop of Loctite® 222 on the thread of each screw.

9.5 Commonly reported problems

THE PUMP DOES NOT FUNCTION AND THE GREEN LED IS NOT LIT.

Solutions

1. Check that the electrical connection is correctly made.
2. Check that the fuse has not blown
3. Replace the electronic circuit with a new one.

THE PUMP FUNCTION CORRECTLY BUT NO LIQUID IS INJECTED IN THE PLANT

Solutions

1. Check the product level in the tank.
2. Check the foot filter which could be closed.
3. Check the injection valve is not closed.
4. Effectuate a maintenance of the suction and delivery valves. Parts showing any chemical attack, should be replaced, with alternative materials if necessary.

CHEMICAL LEAKS FROM THE DOSING HEAD.

Solutions

1. Check that the hose clamps are correctly fitted and tightened.
2. Check that the head bolts are tight and that the O-ring is in its correct position.
3. Parts showing any chemical attack, should be replaced, with alternative materials if necessary.

Chemical Compatibility Table



Dosing pumps are widely used for dosing chemical products. It is important to select the most suitable material for the liquid to be dosed. The CHEMICAL COMPATIBILITY TABLE is a precious aid to that end.

The following Table must be used as an indicative instrument. Modifications in the transported fluid composition or particular service conditions can reduce the resistance of the materials.

Product	Formula	Ceram.	PVDF	PP	PVC	Hastelloy	PTFE	FPM (Viton)	EPDM (Dutral)	NBR	PE
Acetic Acid, Max 75%	CH ₃ COOH	2	1	1	1	1	1	3	1	3	1
Concentrated hydrochloric acid	HCl	1	1	1	1	1	1	1	3	3	1
Hydrofluoric acid 40%	H ₂ F ₂	3	1	1	2	2	1	1	3	3	1
Phosphoric acid, 50%	H ₃ PO ₄	1	1	1	1	1	1	1	1	3	1
Nitric acid, 65%	HNO ₃	1	1	2	3	1	1	1	3	3	2
Sulphuric acid 85%	H ₂ SO ₄	1	1	1	1	1	1	1	3	3	1
Sulphuric acid 98.5%	H ₂ SO ₄	1	1	3	3	1	1	1	3	3	3
Amines	R-NH ₂	1	2	1	3	1	1	3	2	3	1
Sodium bisulphite	NaHSO ₃	1	1	1	1	1	1	1	1	1	1
Sodium carbonate (Soda)	Na ₂ CO ₃	2	1	1	1	1	1	2	1	1	1
Iron chloride	FeCl ₃	1	1	1	1	1	1	1	1	1	1
Calcium hydroxide	Ca(OH) ₂	1	1	1	1	1	1	1	1	1	1
Sodium hydroxide (Caustic soda)	NaOH	2	1	1	1	1	1	2	1	2	1
Calcium hypochlorite	Ca(OH) ₂	1	1	1	1	1	1	1	1	3	1
Sodium hypochlorite, 12.5%	NaOCl + NaCl	1	1	2	1	1	1	1	1	2	2
Potassium permanganate 10%	KMnO ₄	1	1	1	1	1	1	1	1	3	1
Hydrogen peroxide, 30%	H ₂ O ₂	1	1	1	1	1	1	1	2	3	1
Aluminium sulphate	Al ₂ (SO ₄) ₃	1	1	1	1	1	1	1	1	1	1
Copper sulphate	CuSO ₄	1	1	1	1	1	1	1	1	1	1

Component with *excellent resistance* -1-
 Component with *fair resistance* -2-
 Non-resistant component -3-

Construction materials of pump and accessories
 Polyvinylidene fluoride (PVDF): Pump body, valves, fittings, tubes
 Polypropylene (PP): Pump body, valves, fittings
 PVC: Pump body
 Hastelloy C-276 (Hastelloy): Injection valve spring

Disclaimer

The information included in these tables has been obtained from highly qualified sources which we deem reliable and they are provided without any guarantee, explicit or implicit, concerning their exactness.

Conditions or methods for handling, storage and use of the material are beyond our control and/or knowledge.

For this reason and for other reasons we will not be held liable thereof and we expressly waive obligations of claim for damages or relating to the information contained herein.

WARRANTY CONDITIONS

The pumps are warranted to be free from defects in workmanship and material for a period from the delivery date to the first purchaser.

Within the above stated period the producer will supply free of charge any part that upon examination by the producer or by an authorised dealer, is disclosed to have been defective in workmanship or material, or at its option, it will repair the parts directly or through authorised workshops. It remains anyway excluded from whatever responsibility and obligation for others costs, damages and direct or indirect losses that come from the use or the not use availability, either total or partial.

The reparation or the supply in substitution will neither extend nor renew the period of guarantee. They remain anyway at charge of the purchaser the costs of plant pumps mounting and disassembling, transport cost and using materials (filters, valves, and so on).

Producer's duties, as above, are not valid when:

- ◆ **The pumps are not used according to the producer instructions as in the operating manual and maintenance instructions;**
- ◆ **The pumps are repaired, disassembled, modified by workshop not authorised;**
- ◆ **They have used not original spare parts**
- ◆ **The injection plants are damaged by products that are not suitable;**
- ◆ **The electric plants have been damaged because of external causes such as whatever type of over tensions.**

AT THE END OF THE WARRANTY PERIOD FROM THE DELIVERY DATE, THE PRODUCER WILL BE FREE FROM ANY LIABILITY AND FROM ALL THE DUTIES AS ABOVE!

**DIMENSIONI - DIMENSIONS - DIMENSIONS - DIMENSIONES
РАЗМЕРЫ**

Fig. 1 SERIE "HC999" A MURO / WALL MOUNTING / VERSION A PAROI / VERSION A PARED / WANDMONTAGE / НАСТЕННЫЙ

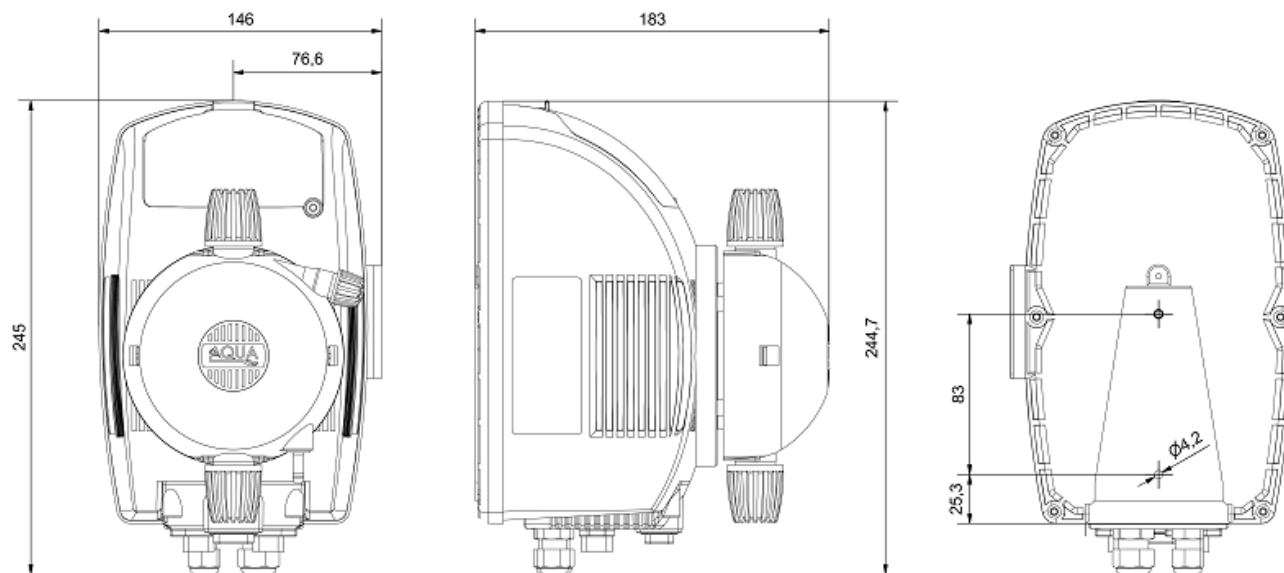

**Fig. 2 SERIE "HC999" CON BASE / BASE MOUNTING / VERSION AVEC BASE
VERSION CON SOPORTE PARA MONTAJE ORIZONTAL / MIT BASIS / С ПОДСТАВКОЙ**

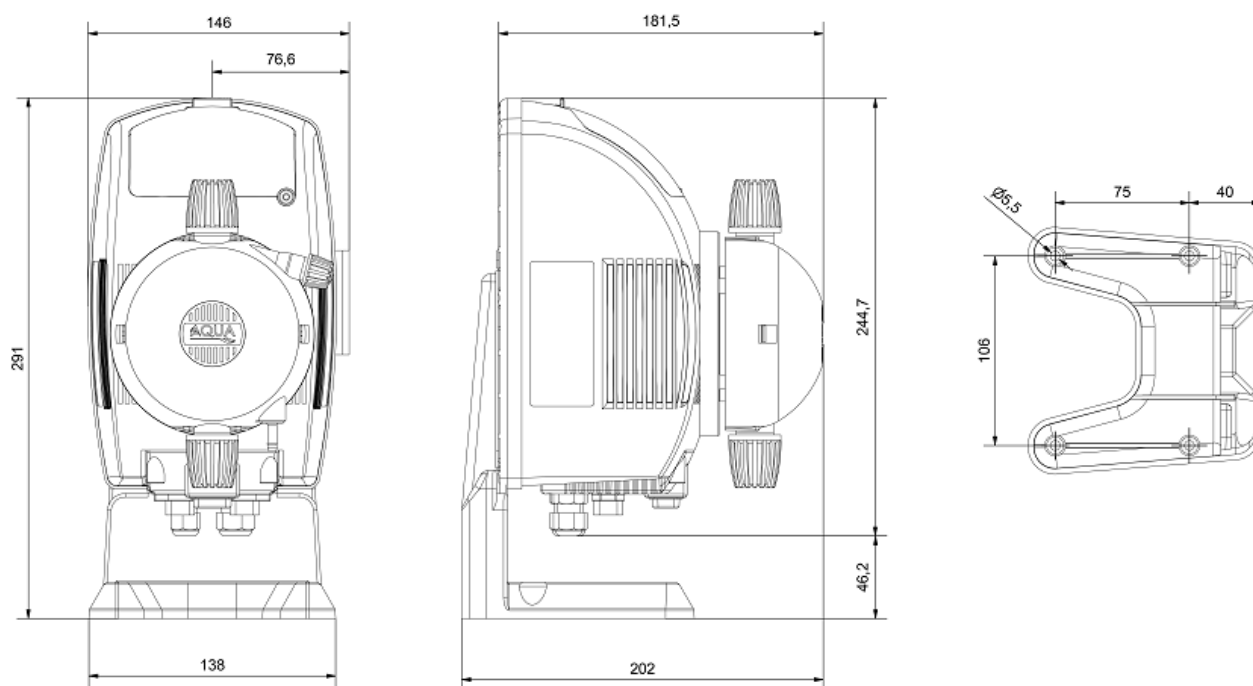

**COLLEGAMENTI ED ESPLOSI - CONNECTION AND EXPLODED VIEWS -
 CONNECTIONS ET EXPLOSE - DIBUJOS - ANSCHLÜSSE UND
 EXPLOSIONSZEICHNUNGEN - СОЕДИНЕНИЯ И ЧЕРТЕЖИ**

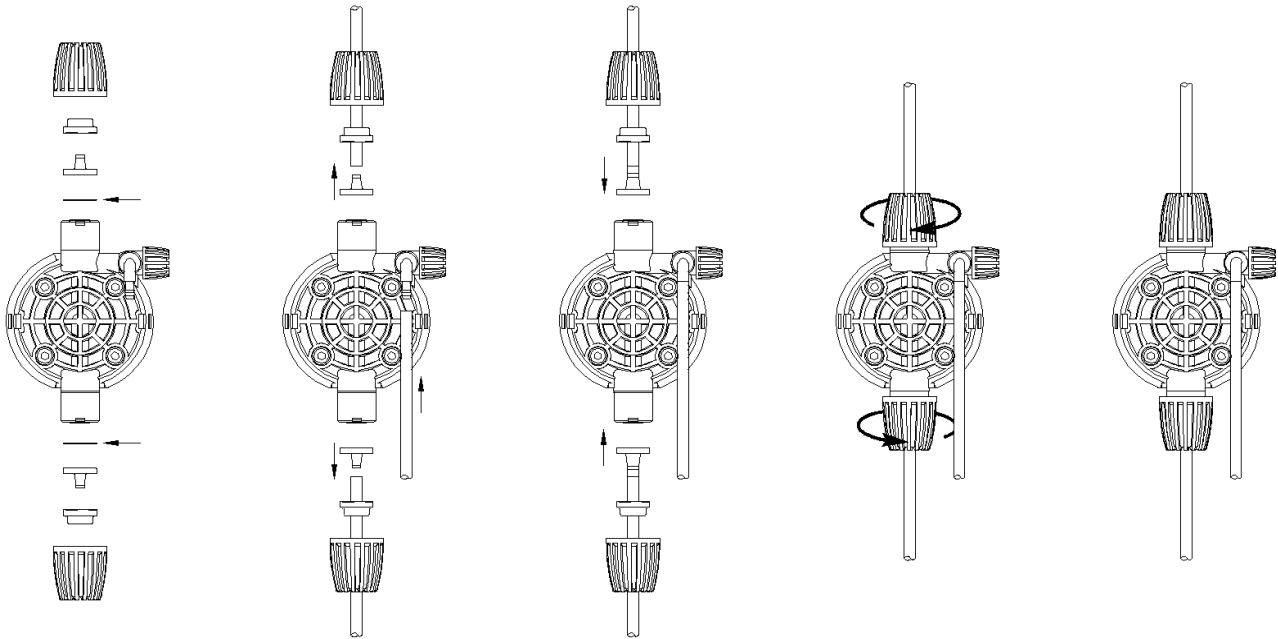

Fig. 3 COLLEGAMENTI TUBI SUL CORPO POMPA - PUMP HEAD TUBING CONNECTIONS

SCHÉMA DE MONTAGE CONNECTIONS EXTERNES - ESQUEMA DE MONTAJE CONNEXIONESTERNAS - SCHLAUCHANSCHLÜSSE AM PUMPENKÖRPER - СОЕДИНЕНИЯ ШЛАНГОВ НА ГОЛОВКЕ НАСОСА

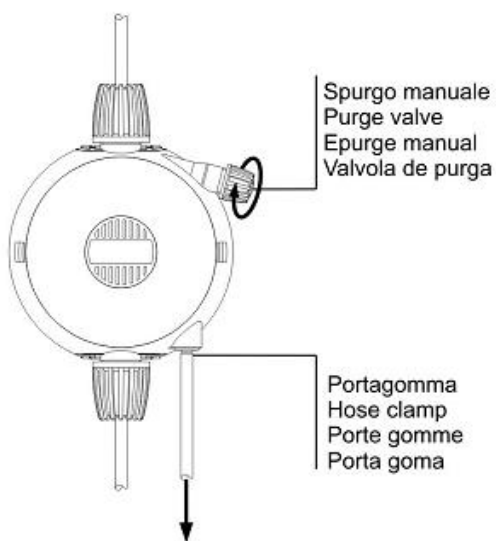

Fig. 4 SPURGO MANUALE - MANUAL RGE

EPURGE MANUELLE - ESPURGO MANUAL- MANUELLE SPÜLUNG - РУЧНОЙ СЛИВ

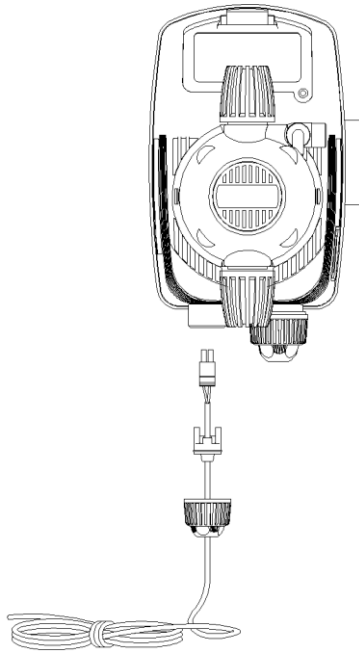

Fig. 5 HC999 COLLEGAMENTO SONDA DI LIVELLO - LOW LEVEL PROBE CONNECTION - SCHÉMA DE MONTAGE SONDE DE NIVEAU - ESQUEMA DE MONTAJE SONDA DE NIVEL - OPTIONAL- ANSCHLUSS DER NIVEAUSONDE - ПОДСОЕДИНЕНИЕ ДАТЧИКА УРОВНЯ – ДОПОЛНИТЕЛЬНАЯ ОПЦИЯ

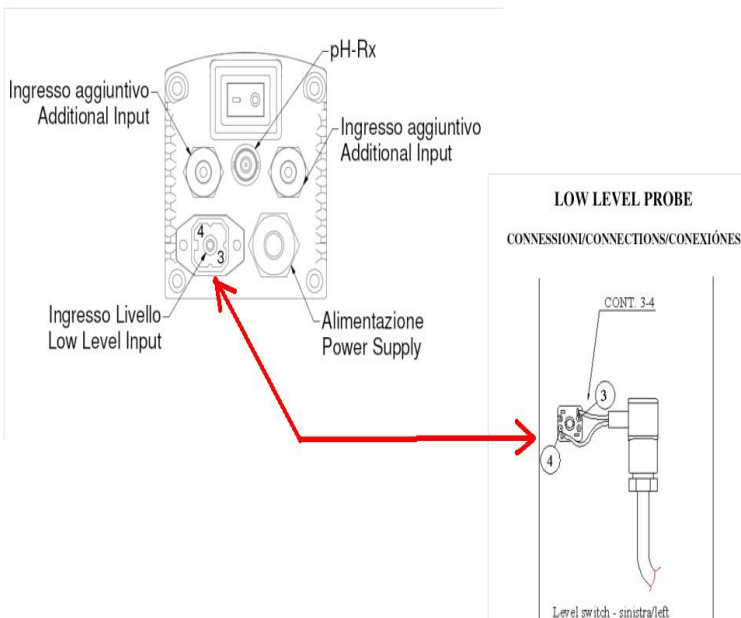
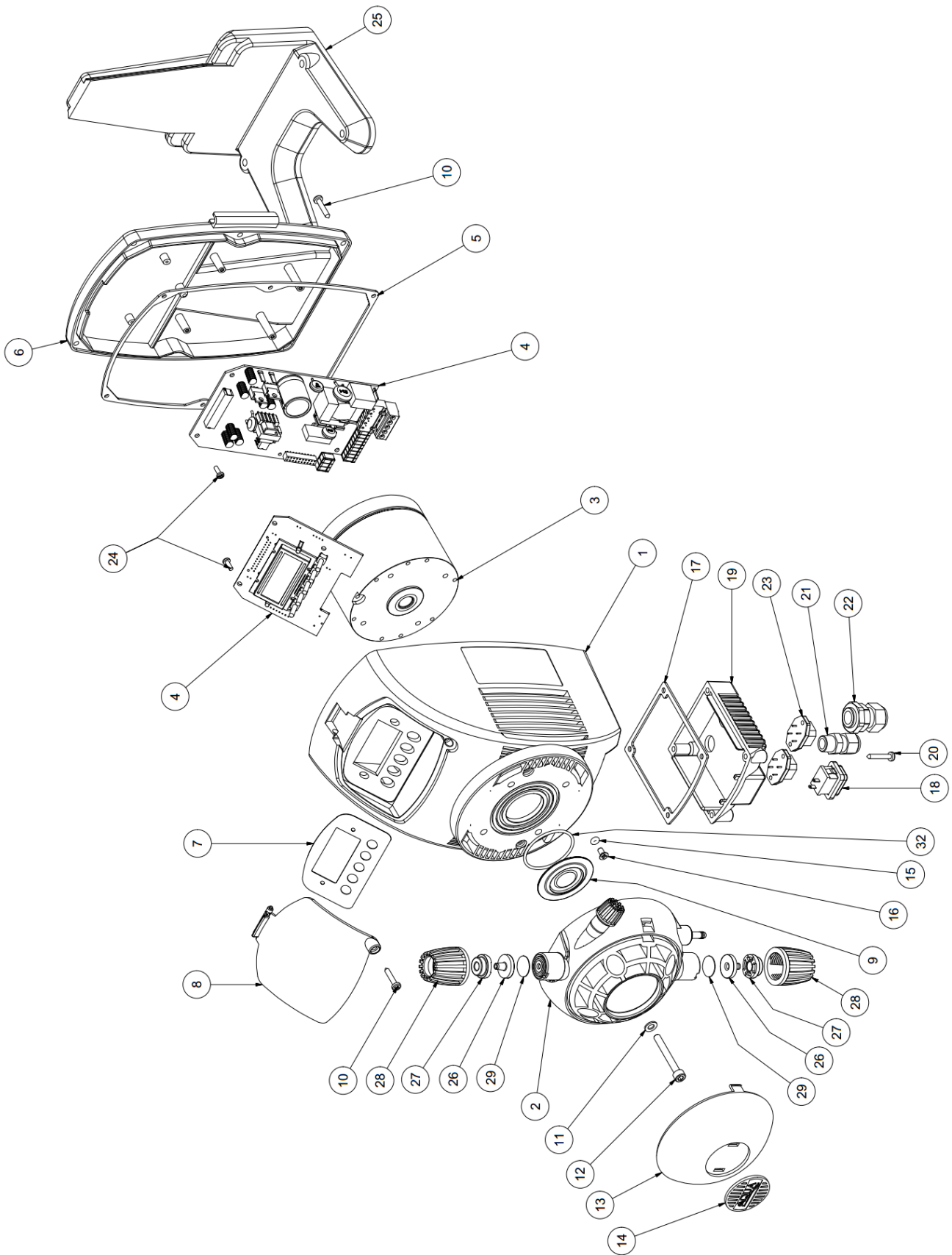

Fig. 6 HC999 COLLEGAMENTO SONDA DI LIVELLO - LOW LEVEL PROBE CONNECTION - SCHÉMA DE MONTAGE SONDE DE NIVEAU - ESQUEMA DE MONTAJE SONDA DE NIVEL - OPTIONAL- ANSCHLUSS DER NIVEAUSONDE - ПОДСОЕДИНЕНИЕ ДАТЧИКА УРОВНЯ – ДОПОЛНИТЕЛЬНАЯ ОПЦИЯ

Fig. 7 SERIE HC 999 - Esploso / Description / Explose / Dibujo / Explosionszeichnung /Чертеж



SERIE HC 999

IT	Codice	Modello	Descrizione	Q.tà
1	ADSP9300030		CASSA HC999 ARNITE NERA D31	1
2	ADSP6000112	1A-2A	CORPO POMPA 4-20/10-10 PP-GL-DT INCOMPLETO - HC999	1
	ADSP6000117	3A	CORPO POMPA 20-05 PP-GL-VT INCOMPLETO - HC999	
3	ADSP6000096	1A - 2A	MAGNETE COMPLETO D90 VERS.1 230V - SILENZIOSO	1
	ADSP6000166	3A	MAGNETE COMPLETO D90 VERS.2-3 230V - SILENZIOSO	
4	ADSP9300040		SKD HC999 PI-MA-CL (EL202+EL202A) 90-260V	1
5	ADSP9300031		GUARNIZIONE HC999 IN GOMMA NBR SP.1,5MM	1
6	ADSP9300023		COPERCHIO HC 999 ARNITE NERA	1
7	ADSP9300027		ETICHETTA POLICARBONATO HC999 NEUTRA	1
8	ADSP9300026		COPERCHIO FRONTALE TRASPARENTE HC999	1
9	ADSP9200001	1A - 2A	DIAFRAMMA PTFE DYNEON 1614 1-14L HC897 M12X1	1
	ADSP6000891	3A	DIAFRAMMA - MEMBRANA IN PTFE D.60X19 - PER 20L-5BAR HC999	
10	ADSP6000767		VITE M 3,5 X 19 UNI 6954 (AF-TCTC) INOX A2	7
11	ADSP6000701		RONDELLA PIANA D. 5 - UNI 6592 INOX A2	4
12	ADSP9000016		VITE M 5 X 30 UNI 5931 (TCEI) INOX A2	4
13	ADSP9300041		COVER IN PP-NERO PER CORPO POMPA HC999	1
14	ADSP9000003		TARGHETTA NERA CON LOGO AQUA PER CORPO POMPA 1-14LT HC897	1
15	ADSP5007072		OR "R1" NBR - 2.60X1.90	2
16	ADSP6000708		VITE M 4 X 8 UNI 7688 (AF-TSTC) INOX A2	2
17	ADSP9000035		GUARNIZIONE COPERCHIETTO ALIMENTAZIONE HC999 GOMMA NBR	1
18	ADSP6000503		INTERRUTTORE BIPOLARE 250V A BILICO SIMBOLO 1/0 CON PROTEZIONE IN GOMMA	1
19	ADSP9300025		COPERCHIO CONNETTORI HC999 ARNITE NERA	1
20	ADSP6000887		VITE M 3,5 X 22 UNI 6954 (AF-TCTC) INOX A2	4
21	ADSP6000424		PRESSACAVO PASSO PG7 - 1900.07 - NERO	1
22	ADSP6000581		PRESSACAVO + DADO PG9 NERO (vn)	1
23	ADSP6000836		CONNETTORE MASCHIO 4 VIE G4A5M CABLATO LIVELLO PANDUIT 2 VIE	2
24	ADSP6000749		VITE M 2,9 X 9,5 UNI 6954 (AF-TCTC) INOX A2	8
25	ADBAS100		BASE SOSTEGNO POMPA HC100 NERA	1
26	ADSP9000014	1A - 2A	ATTACCO TUBO 4X6 GHIERA 1/2" PP	2
	ADSP6000134P	3A	ATTACCO TUBO 6X9 RACCORDO 3/8" PVDF	
27	ADSP9000013	1A - 2A	ADATTATORE TUBO 4X6 GHIERA 1/2" PP	2
	ADSP6001001	3A	ADATTATORE TUBO 6X8 GHIERA 1/2" PVC	
28	ADSP9000012		GHIERA 1/2" PP PER VALVOLA A SFERA NERA	2
29	ADSP9000019		RONDELLA D16X0.5 PE NAT	2
30	ADSP6300910	3A	FLANGIA PISTONE PORTATE MEDIE D.43 - SIL.	1
31	ADSP5007200	1A - 2A	OR - RIF. 3143 - VITON NERO	1
	ADSP5007214	3A	OR - RIF. 3212 - VITON NERO	
32	ADSP5007133	1A - 2A	OR - RIF. ORM0380-20 - VITON NERO	1
	ADSP5007119	3A	OR - RIF. 2212 - VITON NERO	

Fig. 8 HC999 - Corpo pompa valvole a labbro e sfera / Pump head lip and ball valves / Corps pompe et clapets à lèvres et bille / Cuerpo de la bomba valvulas a labio y a esfera / Pumpenkörper Lippen- und Kugelventile / Головка насоса, губчатый и шариковый клапан

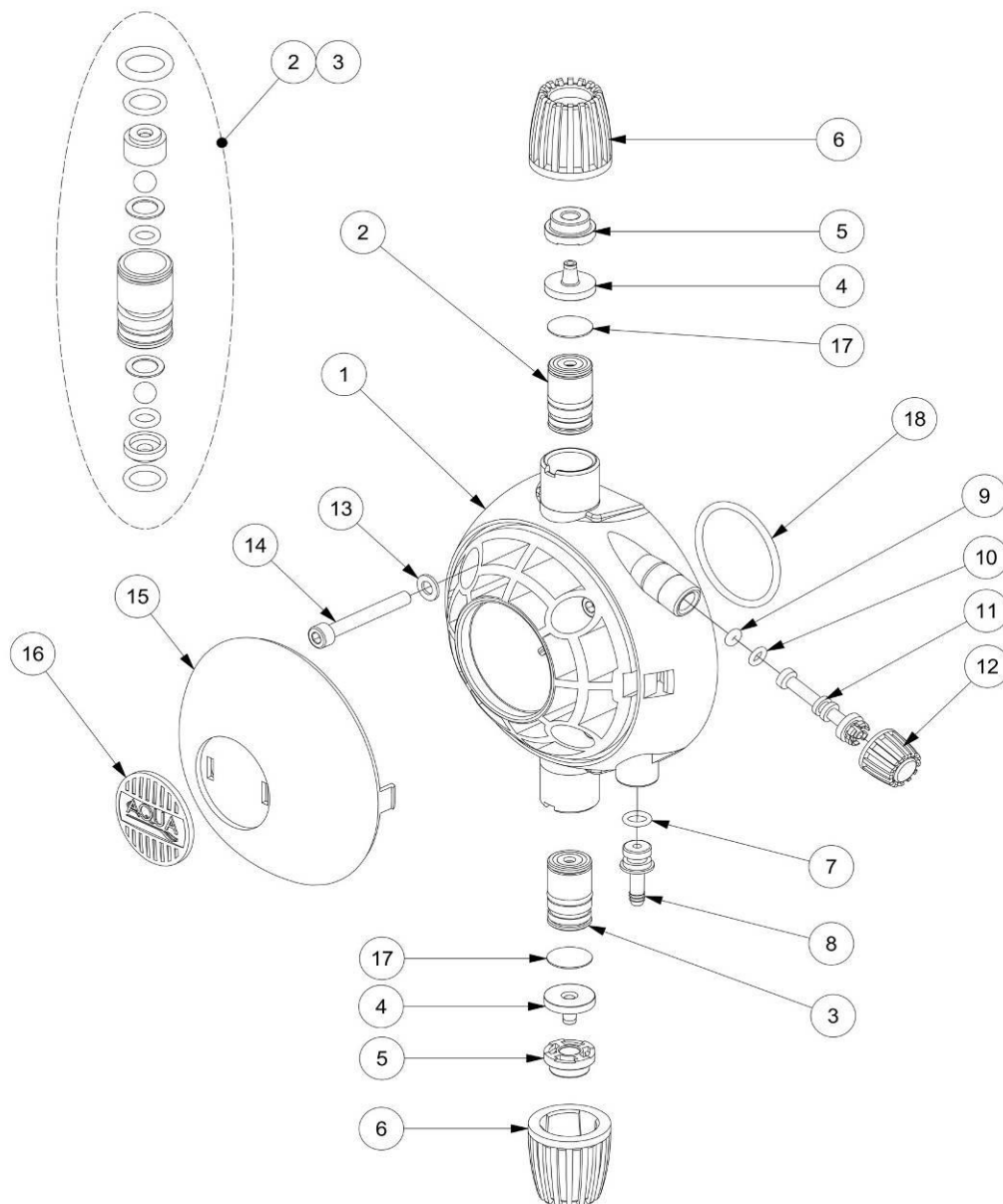

SPARE PARTS HC999 PUMP HEAD

N°	CODICE	Modello	DESCRIZIONE	QTÀ
1	ADSP6000077	1A-2A	CORPO POMPA 4-20/10-10 PP - HC999	1
	ADSP6000794	3A	CORPO POMPA 20-05 PP - HC999	
2	ADSP9005000		GRUPPO VALVOLA 1/2" PP-GL-VT CARTUCCIA ASPIRAZIONE	1
3	ADSP9005001		GRUPPO VALVOLA 1/2" PP-GL-VT CARTUCCIA MANDATA	1
4	ADSP9000014		ATTACCO TUBO 4X6 GHIERA 1/2" PP	2
5	ADSP9000013		ADATTATORE TUBO 4X6 GHIERA 1/2" PP	2
6	ADSP9000012		GHIERA 1/2" PP PER VALVOLA A SFERA NERA	2
7	ADSP5007035		OR RIF. 106 - 1.78x6.75 - VITON NERO	1
8	ADSP6000785		PORTAGOMMA SPURGO CORPO POMPA PP	1
9	ADSP5007072		OR "R1" 2,60X1,90 - NBR	1
10	ADSP6200006		OR - RIF. 2018 - VITON NERO	1
11	ADSP9000004		STELO OTTURATORE PER SPURGO CORPO POMPA HC897 PP	1
12	ADSP9000005		GHIERA 1/4" PER SPURGO CORPO POMPA HC897 PP	1
13	ADSP6000701		RONDELLA PIANA D. 5 - UNI 6592 INOX A2	6
14	MB010700		TCEI - UNI5931 VITE M 5 X 40 UNI 5931 (TCEI) INOX A2-00 00/00/0000	6
15	ADSP9300041		COVER IN PP-NERO PER CORPO POMPA HC999	1
16	ADSP9000003		TARGHETTA NERA CON LOGO AQUA PER CORPO POMPA 1-14LT HC897	1
17	ADSP9000019		RONDELLA D. 16 X 0,5 PE NAT	1
18	ADSP5007200	1A - 2A	OR - RIF. 3143 - VITON NERO	1
	ADSP5007214	3A	OR - RIF. 3212 - VITON NERO	

Fig. 9 Corpo pompa valvole a sfera / Pump head ball valves / Corps pompe à lèvres et bille / Cuerpo de la bomba valvulas a esfera / Pumpenkörper Lippen- und Kugelventile / Головка насоса, губчатый и шариковый клапан

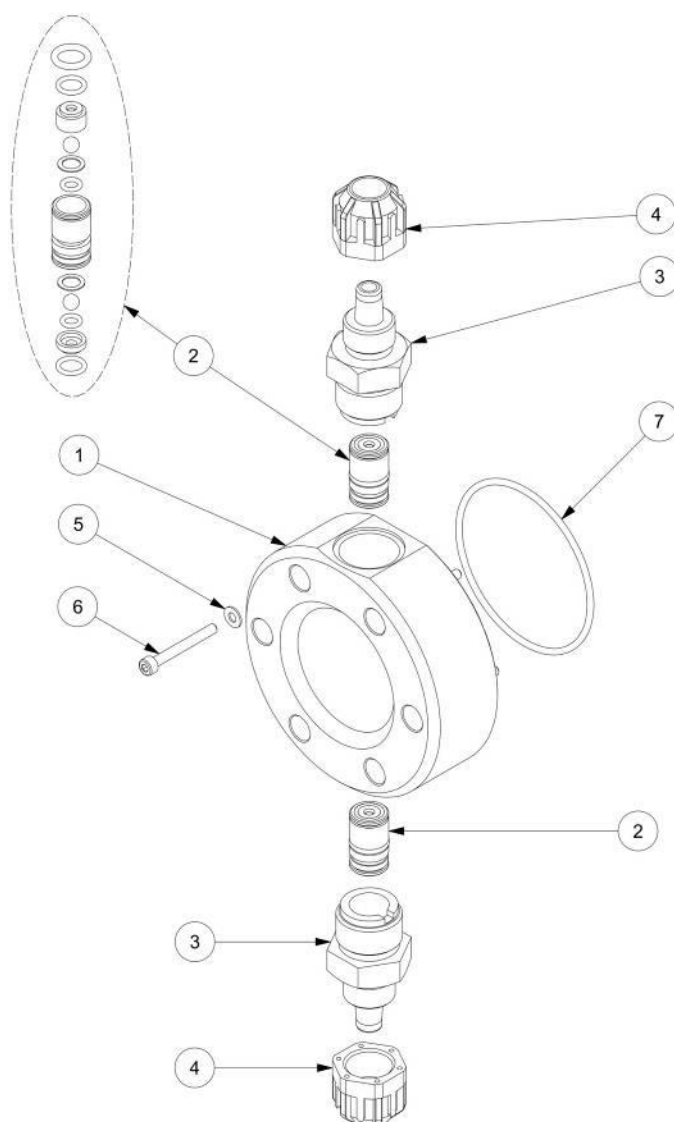

Livello	Codice componente	Descrizione componente	1 [^] Quantita' necessaria
1	ADSP6000776	CORPO POMPA 30-02/50-05 PVC NERO - HC999	1
2	ADSP9005000	GRUPPO VALVOLA 1/2" PP-GL-VT CARTUCCIA ASPIRAZIONE	2
3	ADSP6000781	RACCORDO TUBO 10X14 G3/4 PVC PER VALVOLA SFERA	2
4	ADSP5004002	GHIERA FISSATUBO PP NERA 1/2" 10X14	2
5	ADSP6000805	RONDELLA D. 4 (4.3 x 10,4 x 1) - INOX A2	6
6	ADSP6000723	VITE M 4 X 35 UNI 5931 (TCEI) INOX A2	6
7	ADSP5007044	OR - RIF. 3287 - VITON NERO	1

Note on environmental protection



After the implementation of the European Directive 2002/96/EU in the national legal system, the following applies:

Electrical and electronic devices may not be disposed of with domestic waste. Consumers are obliged by law to return electrical and electronic devices at the end of their service lives to the public collecting points set up for this purpose. Details to this are defined by the national law of the respective country.

This symbol on the product, the instruction manual or the package indicates that the product is subject to these regulations. By recycling, reusing the material or other forms of utilising old devices, you are making an important contribution to protecting our environment.

HC999		
Modello Pompa		Assorbimento Watt
HC899	MOD 3	35
	MOD 4	35



HC999

