

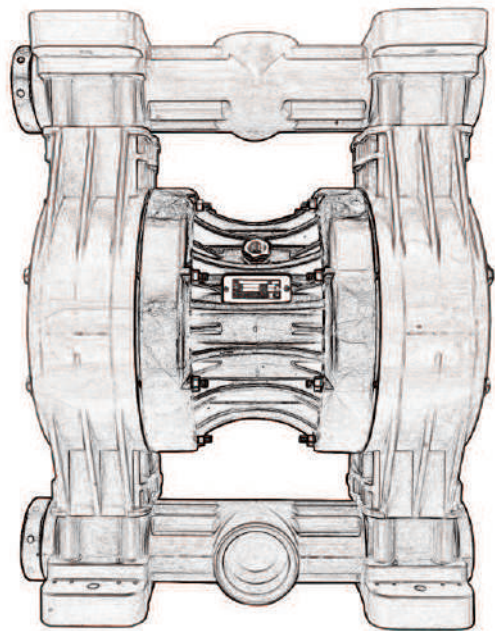

Air Operated Diaphragm Pumps

Installation, Operation and Maintenance

051-081 non Metallic

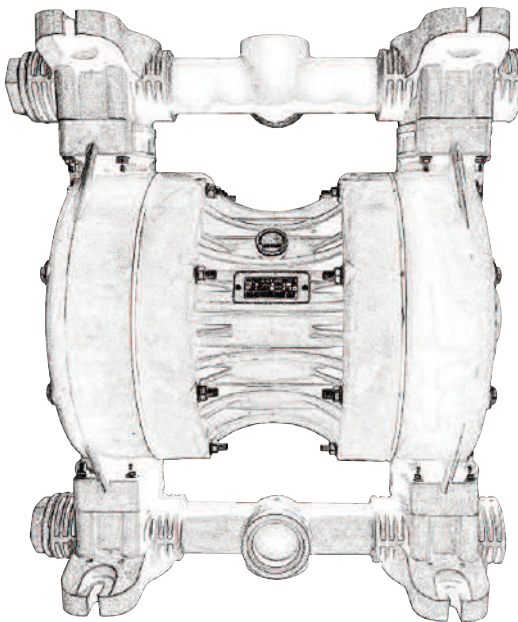

We Make The Difference



INDEX

1.0	Introduction	5
1.1	Warranty	5
1.2	Transport , unpacking , storage	6
1.3	Principle of function	6
1.4	Pump operation	6
1.5	Improper use	6
2.0	Safety Rules	7
3.0	Installation	9
3.1	Connection of air supply line	10
3.2	Connection of suction and pressure lines	10
3.3	Pump in suction operation	10
3.4	Pump in submerged operation	11
3.5	Connecting to the product circuit	11
4.0	Pump Disassembly	11
4.1	Air control valve disassembling	13
4.2	Air control valve assembly	14
4.3	Extracting shaft Bearing	15
4.4	Assembling Diaphragm installation	16
4.6	Replacing the coaxial pneumatic exchanger	17
4.7	Decommissioning	17
4.8	Demolition and disposal	17
5.0	Troubleshooting	18
6.0	Technical data	19
6.1	Dimensional Drawings	20
6.2	Performances	21
6.3	Exploded View and Spare Parts List	23
6.3.1	Exploded view	23
6.3.2	Spare part list	25

1.0 Introduction

The following instructions solely refer to Ruby 051-081 Air Operated Diaphragm Pumps. Since the pumps are used in combination with other assemblies, such as solenoid valves, sensors or pulsation dampers, the valid operating instructions for these components and the associated notes on safety must also be taken into account.

These instructions contain information on safety, installation, operation, maintenance, repair and environmental waste disposal of the Ruby 051-081 Air Operated Diaphragm Pump. Thoroughly read these instructions before use and always follow the information contained therein.

Persons entrusted with the installation, operation, maintenance or repair of the pump must have read and understood these instructions, especially the chapter on "Health and Safety". This applies in particular for those who are only occasionally involved in work on the pump, like cleaning or service personnel.

Each pump is subjected to stringent inspections and function tests before leaving the factory.

You should always bear in mind that a correct function, a long lifetime and optimal operational reliability of the pump mainly depend on

- correct installation
- correct commissioning
- and correctly performed maintenance and repair work.

Enquiries concerning service, spare parts or repairs should be addressed to the manufacturer

Always provide the following information:

- Series
- Pump size
- Serial number of pump

This information is stamped on the identification plate on top of the pump.



Danger!

When returning pumps or pump parts to your supplier for repair or general overhaul, the delivery must be accompanied by certificates stating that pumps or pump parts are free of product and other aggressive or hazardous substances.

1.1 Warranty

The correct function of each Ruby 051-081 Pump is tested in the factory.

However, should any defect appear, please contact the Manufacturer's After-Sales Service, your dealer or the nearest Customer Service Centre where you will receive assistance as quickly as possible. In any case, please provide:

- A- Your complete address**
- B- Pump identification**
- C- Explosion risk protection class**
- D- Anomaly description**

All Ruby 051-081 Pumps are covered by the following warranty:

1. One year for any faulty mechanical parts. The warranty period starts from the date of supply.
2. Any fault or anomaly must be reported to the the Manufacturer within eight days.
3. Warranty repair will be carried out exclusively at the Manufacturer's premises. Transportation charges will be at the client's expense.
4. Warranty shall not be extended in case of repair or replacement.
5. Faulty parts must be forwarded to the Manufacturer who reserves the right to test them in this own factory to identify the fault or any external reason that may have caused it. Should the parts be found not faulty, the Manufacturer reserves the right to invoice the total cost of the parts that had been replaced under this warranty.

Costs and transportation risks of faulty, repaired or replaced parts including custom charges will be borne entirely by the client.

Repair or replacement of faulty parts cover any obligation under this warranty.

The warranty **DOES NOT** cover any indirect damage and in particular any normal consumable material such as diaphragms, ball seats, balls and others.

The warranty does not cover parts damaged as a consequence of incorrect installation, carelessness, neglect, incorrect maintenance, or damages due to transportation or to any other reason or event that is not directly linked to functional or manufacturing defects.

The warranty excludes all cases of improper use of the pump or incorrect applications or non-observance of the information contained in this manual.

Any controversy falls within the jurisdiction of the Court of Athens.

1.2 Transport , unpacking , storage

In order to avoid any problems you should check the delivered goods against the delivery note for completeness and correctness.

Be careful when unpacking the pump and proceed as follows:

- Check the packaging material for transport damage.
- Take the pump carefully out of the packaging material.
- Check the pump for visual damage.
- Remove the plugs from all pump ports.
- Check seals and fluid lines for damage.

The following points must be strictly observed when preparing the pump for storage:

- Store the pump in a dry place.
- Thoroughly clean used pumps before storage.
- Do not subject stored pumps to extreme temperature fluctuations.

1.3 Principle of function

- 1 Discharge manifold
- 2 Top valve ball (closed during suction)
- 3 Diaphragm
- 4 Pump chamber
- 5 Bottom valve ball (opened. Medium flows into chamber)
- 6 Top valve ball (open. Product is pressed out)
- 7 Center Block (the drive air displaces the medium via the diaphragm and at the same time pulls back the second diaphragm)
- 8 Bottom valve ball (closed during delivery)
- 9 Suction manifold
- 10 Air control unit
- 11 Air valve drive

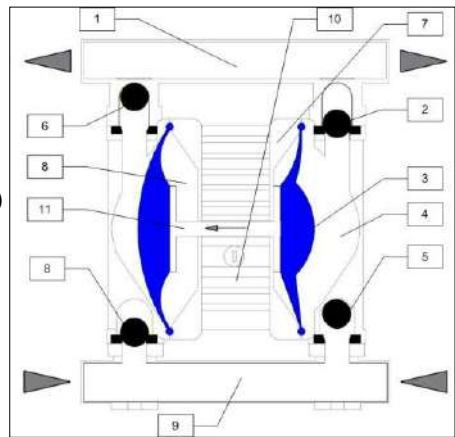

fig.2 Design of pump

1.4 Pump operation

Ruby 051-081 Air Operated Diaphragm Pumps are oscillating positive displacement pumps with two pump chambers arranged opposite each other. Both of these are separated by a diaphragm each into an air and a fluid section.

Both diaphragms are linked by a piston rod, so that with every stroke product is displaced to the outside from the one pump chamber and product is drawn into the opposite pump chamber.

1.5 Improper use

Particularly, it is **FORBIDDEN** to use Ruby 051-081 pumps for :

- production of vacuum;
- operation as an on-off valve, as a non-return valve or as a metering valve
- operation with liquid that is chemically incompatible, with the materials of construction;
- operation with suspended products whose specific weight is higher than the liquid's (for example with water and sand) .
- With air pressures, temperatures or product characteristics that do not comply with the pump's technical data .



WARNING: since an endless variety of products and chemical compositions exist, the user is presumed to have the best knowledge of their reaction and compatibility with the pump's construction materials. Therefore, before using the pump, all necessary checks and tests must be performed with great care to avoid even the slightest risk, an event that the manufacturer cannot foresee and for which he cannot be held responsible.

 **WARNING:** the user must consider the ratio between the pump's maximum surface temperature indicated on the marking and the minimum ignition temperature of the layers and clouds of powder as shown in the EN1227-1.

 **WARNING.** Use of the pump that does not comply with the instructions indicated in the use and maintenance manual will cancel the safety and explosion protection requirements. The risks associated with use of the pumps under the exact conditions set forth in the use and maintenance manual have been analysed, whilst the analysis of the risks associated with the interface with other system components must be carried out by the installer

The user is responsible for classifying the area of use whilst identification of the equipment category is the responsibility of the manufacturer

2.0 Safety Rules

Dangerous or hazardous practices or practice not complying with the safety rules and with the recommendations contained herein, may cause serious injuries, material damage and even explosions and /or death for which the manufacturer cannot be held responsible.

 **WARNING:** these instructions are essential for the pumps' compliance to the requirements of the 2006/42/EC directive and must therefore be available, known, understood and applied.

 **WARNING:** the personnel in charge of installing, inspecting and servicing the pumps must have suitable technical knowledge and training in matters concerning potentially explosive atmospheres and the related risks

 **WARNING:** use of the pumps in a manner that does not comply with the instructions indicated in the use and maintenance manual will cancel all the requirements for safety and protection against of explosions.

 **WARNING:** before intervening on the pump and/or servicing or repairing it, please- note that you must:

- A - Discharge any product that was being pumped
- B - Wash it internally using a suitable non-flammable fluid, then drain.
- C - Cut-off the air supply using the relevant valve and make sure that no residual pressure remains inside it.
- D - Close all on-off valves (delivery and intake sides) relative to the product.
- E - Disconnect the network air supply;
- F- Wear suitable individual protection before any maintenance or repair {goggles / face protection, gloves, closed shoes, aprons and others}.

 **WARNING:** before using the pump, make sure that the fluid to be pumped is compatible with the explosion protection class and with construction materials of the pump.

DANGER OF CORROSION, PRODUCT SPILLS AND/ OR EXPLOSIONS CAUSED BY CHEMICAL REACTIONS

For installation and use in a potentially explosive environment, comply with these general precautions

- ascertain that the pump is full and if possible, that the level is above it by 0.5 m;
- ascertain that the fluid treated does not contain or cannot contain large solids or solids of a dangerous shape
- ensure that the intake or delivery ports are not obstructed nor limited to avoid cavitation or pneumatic motor strain.

- also ascertain that the connection piping is strong enough and cannot be deformed by the pump weight or by the intake. Also check that the pump is not burdened by the weight of the piping
- If the pump is to stay in disuse for a long period of time, clean it carefully by running a non-flammable liquid detergent through it that is compatible with the pump's construction materials
- if the pump was turned off for a long period of time, circulate clean water in it for some minutes to avoid incrustations.
- before starting, after long periods of disuse, clean the Internal and external surfaces with a damp cloth;
- check the grounding;
- always protect the pump against possible collisions caused by moving objects or by various blunt materials that may damage it or react with its materials;
- protect the pump's surrounding ambient from splashes caused by accidental pump failure;
- if the diaphragms are completely torn, the fluid may enter the air circuit, damaging it, and be discharged from the exhaust port. It is therefore necessary for the exhaust port to be conveyed by pipes to a safe area.

 **WARNING: the air supply pressure must never be over 7 bar or below 2 bar**

 **WARNING: when using the pump with aggressive or toxic liquids or with liquids that may represent a health hazard you must install suitable protection on the pump to contain, collect and signal any spills: DANGER OF POLLUTION, CONTAMINATION, INJURIES AND/OR DEATH.**

 **WARNING: the pump must not be used with fluids that are not compatible with its construction materials or in a place containing incompatible fluids.**

 **WARNING: installing the pumps without on/off valves on the intake and delivery sides to intercept the product in case of spillage is forbidden: danger of uncontrolled product spillage**

 **WARNING: installing the pumps without on-off, three way or check valves on the air supply piping to prevent the pumped liquid from entering the pneumatic circuit if the diaphragms are broken is forbidden: danger of fluid entering the compressed air circuit and being discharged into the environment**

 **WARNING: Should the user think that the temperature limits set forth in this manual may be exceeded during service, a protective device must be installed on the system to prevent the maximum allowed process temperature from being reached.**

If exceeded, respect of the maximum temperature marked cannot be guaranteed

 **WARNING: The pumps must always be grounded irrespective of any organ to which they are connected. Lack of grounding or incorrect grounding will cancel the requirements for safety and protection against the risk of explosion**

 **WARNING: the use of pumps made with non-conductive material, which become charged with static, and without suitable grounding for flammable liquids is forbidden: RISK OF EXPLOSIONS DUE TO STATIC CHARGE**

 **WARNING : Aggressive, toxic or dangerous liquids may cause serious injuries or damage to health, therefore it is forbidden to return a pump containing such products to the manufacturer or to a service center. You must empty the internal circuits from the product first and wash and treat it.**

 **WARNING: Pumps containing aluminium parts or components coming into contact with the product cannot be used to pump III-trichloroethane, methylene chloride or solvents based on other halogenated hydrocarbons: DANGER OF AN EXPLOSION CAUSED BY A CHEMICAL REACTION**

 **WARNING: The components of the pneumatic exchanger, including the shaft are made from materials that are not specifically resistant to chemical products, if the diaphragm should break, replace these elements completely if they have come into contact with the product**

 **WARNING:**The air-driven motor of the Ruby 051-081 pumps is self-lubricating and will not require any greasing. Therefore a void using lubricated and non- dried air.

 **WARNING:** ascertain that during service no anomalous noise appears. In that case, stop the pump immediately

 **WARNING:** ascertain that the fluid at the delivery side does not contain gas. Otherwise stop the pump immediately

 **WARNING:** Periodic controls must be made to ensure that there is no powder and/or deposits on the external and internal surfaces of the pump and, if necessary, they must be cleaned with a damp cloth

 **WARNING:** removal of the silencer and the air supply fitting must be done when free from powder. Before restarting the pump, ensure that no powder has entered the pneumatic distributor.

To replace worn parts, use only original spare parts.

Failure to comply with the above may give rise to risks for the operator, the technicians, the persons, the pump and/or the environment that cannot be ascribed to the manufacturer.

 **WARNING:** diaphragm pumps with negative suction are affected by the following factors:

- viscosity and specific weight of the fluid;
- suction diameter and length.

Position the pump as close as possible to the point of collection (within 2.5 m.) and in any case never more than 5 m. The diameter of the intake pipe must never be smaller than the connection of the pump, but must be increased as the distance increases. Fluid to be pumped with negative suction must never exceed a viscosity of 5.000 cps at 20° C and a specific weight of 1.4 Kg/l. These elements can cause derating and reduce the duration of the diaphragm: **DANGER OF PREMATURE BREAKAGE.**

3.0 Installation

To be observed before installation

1. The installation must only be carried out by persons who have the necessary skills for this work
2. Before installation align the pump correctly and fasten it without any tension. Pipelines must be assembled in a way that the basic weight of the lines is not resting on the pump
3. In order to avoid damage to the pump new installations should generally be checked for any debris (welding beads, pieces of wire, etc.) in tank and pipeline system.
4. Consider the arrangement of the pump with respect to suction and discharge heads.
5. The pump system must be designed according to the requirements of the application. Valves or spools must be installed as close as possible to pressure port. This also applies for T-fittings with valve for bypass control or pressure relief valves, pressure gauges, flow control valves and shut-off valves.
6. Thoroughly examine the alignment of the pump with the pipelines, in order to avoid strain and premature wear.
7. Check all pipelines for leaks. This applies in particular for the suction line, in order to avoid the intake of air.
8. If the fluid to be pumped contains solid particles bigger than specified, a filter must be installed. The filter must be of such a size, that the change in resistance at the pump inlet port is only minor. This filter must be permanently monitored and, if necessary, cleaned.
9. Fluids which change their viscosity must be permanently agitated, or the tank must be fitted with a temperature sensor. With increasing viscosity start the agitator and/or the heating. This is of special importance for intermittent operation!

Note: It is recommended to install flexible, shape and pressure resistant hoses or compensators at the suction and pressure ports of the pump (Fig. 3). This will prevent the transfer of pulsation shocks into the pump.

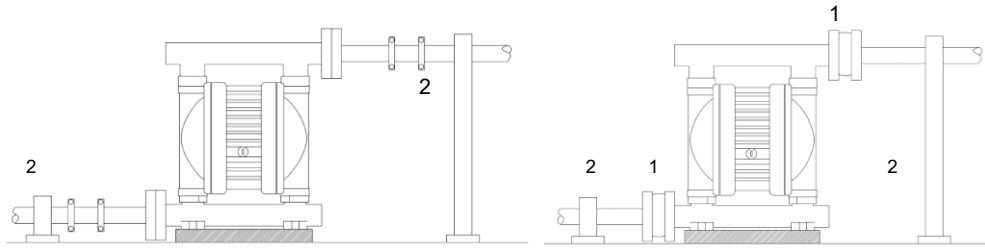

1. compensators , 2. pipeline support
 Fig 3. Installation proposal for diaphragm pump

1. Water separator
2. Filter
3. Pressure reducer
4. Pressure Gauge
5. Needle valve
6. Pulsation dampener
7. Shut-off elements on Suction and pressure side.

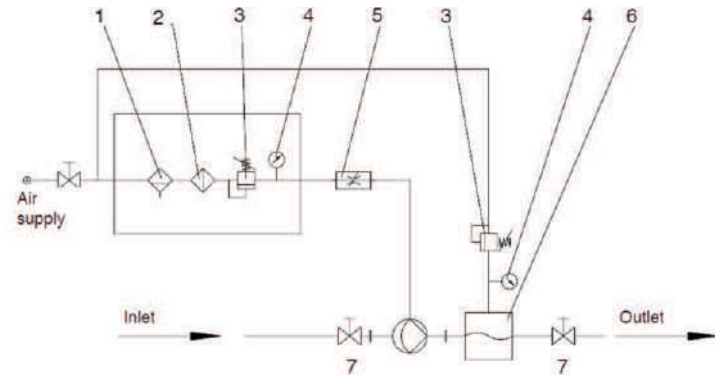

3.1 Connection of air supply line

We recommend to supply the air through a hose to the pump. Using moisturized compressed air requires the installation of a service unit with water separator. This control equipment can additionally be used to regulate the flow capacity of the pump. The diaphragm must not be subjected to shockloads. For this reason we recommend the installation of a spool, diaphragm or needle valve as shut-off element.



WARNING: pneumatic supply to the Ruby 051-081 pumps must be made using **FILTERED, DRIED, NON LUBRICATED OIL FREE AIR** at a pressure of not less than 2 bars and not more than 7 bars.



WARNING: do not remove **RESET** for any reason and/or do not connect the air supply to the **RESET** channel



Warning! Do not use a ball valve as shut-off element

Note: Especially for plastic pumps or pumps with PTFE diaphragms it is highly recommended to install a slow start valve in the supply line to the pump. This valve protects both the diaphragm and housing parts against suddenly occurring pressure shocks.

3.2 Connection of suction and pressure lines

Suction and pressure lines must be installed in a way that no additionally loads are applied to the pump ports.

The tightening torque of the mounting screws and the pressure strength of the sockets and flanges must be observed with the installation of the suction and pressure lines. After assembly check the system for leaks

3.3 Pump in suction operation

Ruby 051-081 Air Operated Diaphragm Pumps are dry self-priming. Depending on the pump design a suction head of max. 9 m Wc can be reached, when the suction line is filled.

3.4 Pump in submerged operation

The Ruby 051-081 Air Operated Diaphragm Pumps are suitable for submerged operation. However, it must be assured that the surrounding fluid will not attack the pump.

When installing the pump make sure that the air discharge muffler has been removed and the exhaust air is discharged from the fluid through a hose.

3.5 Connecting to the product circuit

After positioning the pump you can now connect it to the product circuit as follows:

 **WARNING: only fittings with cylindrical gas threads in materials compatible with both the fluid to be pumped and the pump's construction materials must be used.**

For example:

Pump made from PP - PP fitting

Stainless steel pump = stainless steel fitting.

1. On the suction and discharge manifold install a manual valve of the same diameter as the pump inlet (never smaller) to intercept the fluid correctly in case of spills and / or when servicing the pump.
2. Install the sleeves to secure the flexible hoses on both valves.

 **WARNING: the pump must be connected with FLEXIBLE HOSES REINFORCED WITH A RIGID SPIRAL of a diameter never smaller than the pump's connection. The filters or other equipment installed at the intake side must be suitably dimensioned in order to avoid pressure drops. For negative installations and/or viscous fluids, use hoses with an OVERSIZE DIAMETER, especially on the intake side. Connections using rigid pipes may cause strong vibrations and break the manifolds**

3. Connect the product intake and delivery hoses to their respective fittings whilst taking into consideration the signs on the pump:

1N" = INTAKE (down) and

OUT" = DELIVERY (up)

or according to that indicated by the arrows.

4. Secure the hoses using the relevant clamps.

 **WARNING: Provide appropriate support for the piping. THE PIPING MUST BE STRONG ENOUGH TO AVOID DEFORMATION DURING THE SUCTION PHASE AND MUST NEVER WEIGH DOWN ON THE PUMP IN ANY WAY OR VICE VERSA .**

- 5 . If used for drum suction (not below head), the submersed end of the intake hose must be provided with a diagonally cut fixing to prevent it from adhering to the drum bottom.

WARNING: Ascertain that the fluid treated does not contain or cannot contain large solids or solids of a dangerous shape and that the intake or delivery ports are not obstructed nor limited to avoid either cavitation or pneumatic motor strain.

Connection off the product circuit finishes here.

4.0 Commissioning

The user must always use materials that are compatible with the pumped liquid according to the pump's design conditions.

 **WARNING: it is forbidden to use the pump with fluids that are not compatible with the pump's construction materials or in a place that contains incompatible fluids.**

To commission the pump, proceed as follows :

1. Make sure that the product delivery and intake hoses are correctly connected - check the signs on the pump:
"IN" = INTAKE (down) and
"OUT" - DELIVERY (up)

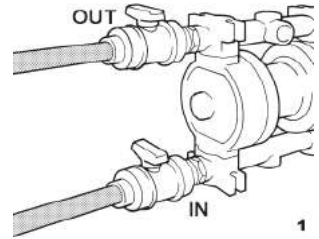

2. Check that the pump's pneumatic circuit valves are correctly installed (on-off ball valve, three-way valve and check valve).
3. Open the fluid intake and delivery Valves.

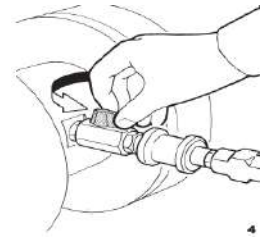
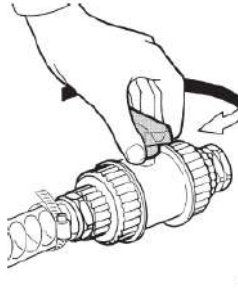
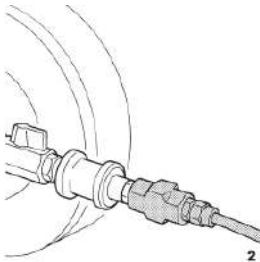

WARNING: never start the pump with the product valves {intake and delivery} closed:
DANGER OF DIAPHRAGM BREAKAGE.

4. Open the on-off ball valve mounted on the pump connection.
5. Open the three-way valve.
6. Check and regulate the network air pressure when the pump is running: MIN 2 bar MAX 7 bar; max 5 bar for pumps with rubber balls

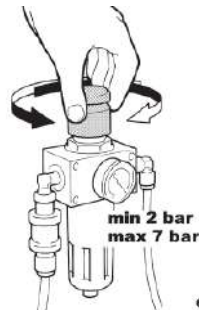
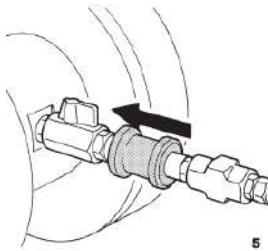

CAUTION: If the pressure is below 2 bars when the pump is running, the pump may STALL. At a pressure higher than the MAXIMUM threshold, yielding and leakages of the product under pressure may occur and/or the pump may break.

7. To regulate the speed of the pump according to the fluid viscosity, you can operate in two ways:
A- Regulate the network air pressure.
B- Choke the air volume (flow rate) by means of the on-off valve mounted on the pump

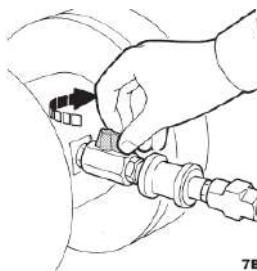

REMARK: unprimed pumps have a negative suction head capacity that varies according to the type of diaphragm and packing mounted. PLEASE CONTACT THE MANUFACTURERS CUSTOMER ASSISTANCE SERVICE FOR FURTHER DETAILS

WARNING: If the pump has negative suction, reduce the speed of the pump using the ball valve on the air supply.

WARNING: In pumps with split manifold. DO NOT USE TWO FLUIDS WITH DIFFERENT VISCOSITIES as STALL. PREMATURE DIAPHRAGM AND PNEUMATIC CIRCUIT WEAR may occur .

WARNING: never stop the pump when it is running and/or when the pneumatic circuit is under pressure by closing the intake and/or delivery valves on the fluid circuit: DANGER OF PUMP STALLING AND PREMATURE WEAR AND/OR BREAKAGE OF THE DIAPHRAGM.

8. Only the air supply must be used to stop the pump, by closing the three-way valve to discharge any residual pressure from the pump's pneumatic circuit.

Besides being damaging for the pump, cavitation is dangerous in a potentially explosive atmosphere:

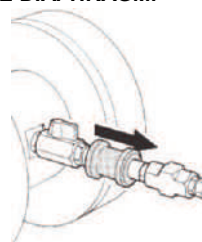

You must ascertain that the pump has been sized correctly. In case of doubt, please contact ALPHADYNAMIC.

WARNING: ascertain that no anomalous noises occur during operation. If so, stop the pump immediately .

WARNING: ascertain that the fluid at the delivery side does not contain gas. Otherwise stop the pump immediately

WARNING: In the case of high viscosity fluids, do not use under-sized filters or piping, especially the intake side. Furthermore , you must decrease the pump speed by choking the volume of air whilst leaving pressure unchanged.

9. After two hours of operation, and after stopping the pump correctly, check that all of the bolts are tight.

4.1 Product circuit maintenace

WARNING: before intervening on the pump and/or performing any maintenance or repair, you must:

A - discharge the product being pump cd and close the product on-off valves (both on the intake and delivery sides) .

B- Circulate a suitable non-flammable washing fluid then drain it off and close the product shut-off valve.

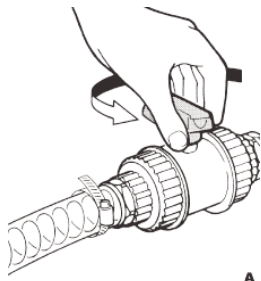

A

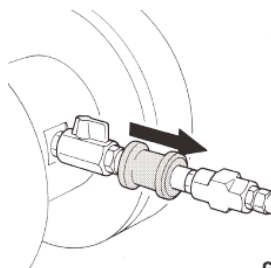

C

C- Shut-off the air supply using the relevant three-way valve whilst making sure that no residual pressure subsists

D -Shut-off air supply upstream:

E - Wear suitable individual protective devices before intervening: goggles / masks, gloves, closed shoes, aprons, and others: DANGER OF FLUID EJECTION UNDER PRESSURE.

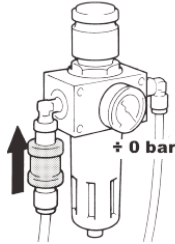

D



E



WARNING: remove deposits of powder from the external surfaces of the pump with a cloth soaked in suitable neutral detergents.

1. Disconnect fluid intake and delivery hoses from pump.

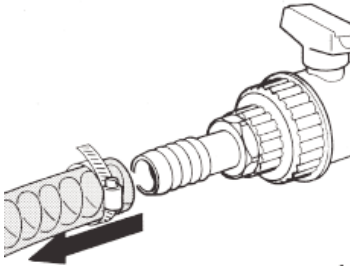

1

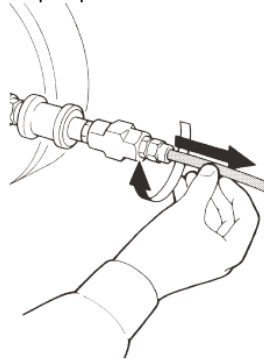

2

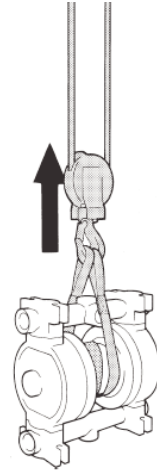

3

2. Disconnect the compressed air supply pipe from the pump.

3. Disassemble and remove the pump from its place of installation using suitable hoisting equipment.

4. Periodically control and clean the internal surfaces with a damp cloth.

4.2 Cleaning and replacing the balls and ball seats

To clean and/or replace the balls and ball seats, proceed as follows:



WARNING: before carrying out this operation all external surfaces of the pump must be cleaned using a damp cloth.

A1 disassemble the intake and delivery manifolds by removing the fixing elements.

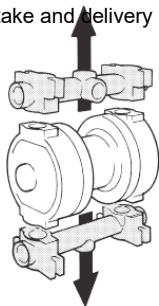

A1

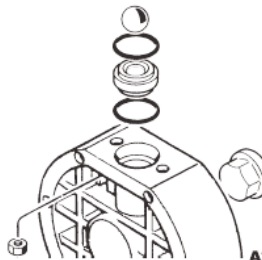

A2

A2 Remove the seats and the balls and clean them with a damp cloth and/OR replace them with genuine spare parts of the same type (see spare parts tables).

A3 Check the condition of the gasket and, if necessary, replace with original spare parts of the same type.

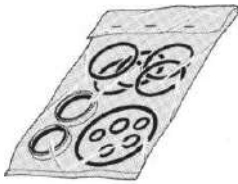

A3



A4



WARNING: check that there are no deposits of any kind inside the pump, and if found remove them with a damp cloth.

A4 Reassemble by repeating the previous sequence in reverse order. Tighten the fixing bolts evenly.

Cleaning and/or replacement of balls and ball seats finishes here. You can now reposition the pump and reconnect it as described in the previous sections.

4.3 Cleaning and replacing the diaphragms

For good operation of the pump and to guarantee that all the safety and protection requirements against explosion risks have been taken, it is indispensable that the controls, cleaning and/or replacement of the diaphragms are carried out in accordance with the intervals shown in the table.



WARNING: the diaphragms (in contact with the-product or the external ones) are highly subject to wear. Their duration is strongly affected by the conditions of use and by chemical and physical stress. Field tests carried out on thousands of pumps installed with a head equal to 0C and with fluid at 18' C have shown that normal service like exceeds 100.000.000 (one hundred million) cycles. For safety reasons, in environments at risk of explosion, the diaphragms must be replaced every 20.000.000 (twenty million) cycles.

OBLIGATORY OPERATION	OPERATION TIME (n.r of cycles)		
	Every 500,000	Every 5 million	After 20 million
CONTROL AND INTERNAL CLEANING	•		
DIAPHRAGM CHECK		•	
DIAPHRAGM REPLACEMENT			•

To replace product diaphragms proceed as follows:



WARNING: The components of the pneumatic exchanger, including the shaft, are made from materials that are not specifically resistant to chemicals. Should the diaphragms break and the components come into contact with the fluid, replace them completely.

B1 Disassemble the intake and delivery manifolds by removing the fixing elements.



WARNING: Periodic controls must be made to ensure that there are no deposits of powder on the internal surfaces and, if necessary, they must be cleaned with a damp cloth.

B2 Remove any deposits on the internal surfaces with a damp cloth.

B3 Disassemble the two pump casings by removing the fixing Screws.

B4 Remove the external diaphragm locking plate from both circuits.

B5 Check and/or replace the diaphragms on both sides of the pump with original spare parts of the same type.



WARNING: ascertain that the inner part of the pump is free from all types of deposits and if they are present proceed with their removal

B6 Reassemble the pump following the disassembly sequence described earlier in reverse order. Tighten the fixing bolts evenly.

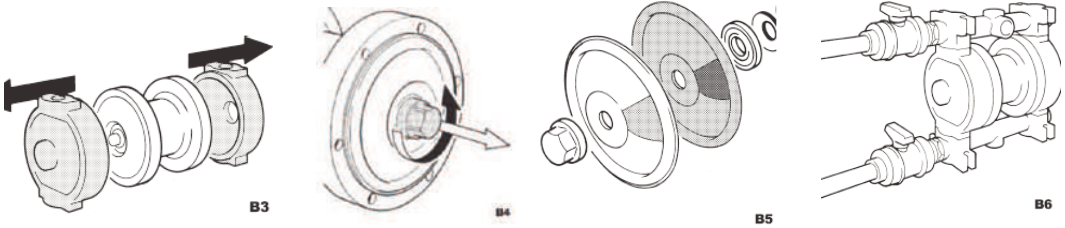

WARNING: Should the pump be returned to the manufacturer or to a service center, you must first empty it out completely. If toxic, noxious or other types of dangerous products have been used, the pump must be suitably treated and washed before it is sent.

Replacing the diaphragms finishes here. You can now reposition the pump and reconnect it as described in the previous sections.

4.4 Air circuit maintenance



WARNING: before intervening on the pump and/or before performing any maintenance or repair, you must:

- A- Discharge the product that is being pumped and close the manual on-off valves (both on the intake and delivery sides)
- B- Circulate a suitable, non-flammable washing fluid then drain it out and close the product shut-off valve.
- C- Shut-off the air supply using the relevant three-way valve which making sure that no residual pressure subsists:
- D- Shut- off air supply upstream:
- E- Wear suitable individual protective devices before intervening: goggles/masks, gloves, closed shoes, aprons and others : DANGER OF EJECTION OF FLUID UNDER PRESSURE.

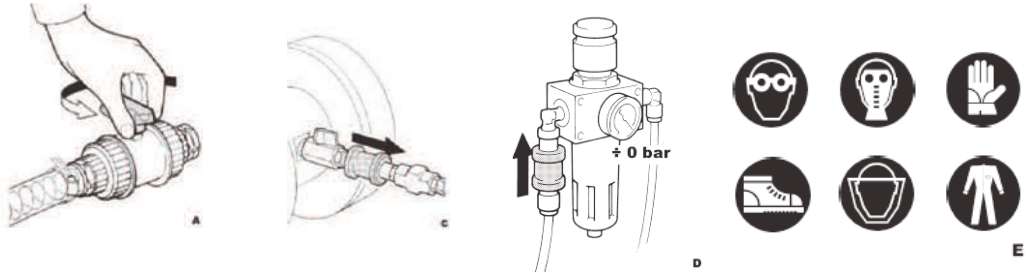

WARNING: Before removing the air supply pipe or fitting, clean the external surfaces of the pump. Before restarting the pump, ensure that no powder has entered the pneumatic distributor.

- 1 Disconnect the fluid in take and delivery hoses from the pump;
- 2 Disconnect the compressed air piping from the pump.
- 3 Disassemble and remove the pump from its place of installation using suitable hoisting: means.

4.6 Replacing the coaxial pneumatic exchanger

All Ruby 051-081 pumps, with the exception of Ruby 051-081 pumps, have a coaxial pneumatic exchanger; to replace it proceed as follows:

WARNING: Should the pump be returned to the manufacturer or to a service center, you must empty it out completely. If toxic, noxious or other types of dangerous products have been used, the pump must be suitably treated and washed before it is sent.

B1 Disassemble the intake and delivery manifolds by removing their fixing elements.

B2 Disassemble the two pump casings by removing the relevant fixing screws.

B3 Remove the external diaphragm locking plate from both the circuits.

B4 Remove the diaphragms from both sides of the pump.

B5 Disassemble the pneumatic exchanger by removing the relevant fixing elements.

B6 Replace the exchanger and the connection shaft with original spare parts having the same characteristics.

B6.1 For pumps with manual reset on the main casing, the air exchanger must be placed so that the reference bevel is turned towards the resetting duct.

B7 Reassemble the pump according to the previously described sequence but in reverse order and tighten the fixing bolts evenly.

WARNING: to avoid incorrect reassembly and subsequent malfunction of the pump the coaxial pneumatic exchangers must not be open.

Replacement of the coaxial pneumatic exchanger finishes here. You can now reposition the pump and reconnect it as described in the previous sections.

4.7 Decommissioning

Should the pump remain inactive for long periods, proceed as follows

WARNING; Discharge any residual fluid from the pump. In case of dangerous, toxic fluids and/or otherwise noxious products, wash and treat as suitable: DANGER OF INJURIES. DAMAGE TO HEALTH AND/OR DEATH.

1. Wash internally using products suitable for the fluid being pumped.
 2. Close the fluid intake and delivery valves mounted on the pump.
 3. Close the air supply using the three-way valve; this will discharge any residual pressure.
4. If you want to store the pump in the warehouse, you must respect the following:

WARNING: Storage must be in a closed and protected environment at temperatures ranging from 5 to 45C, and a humidity level not above 90%.

5. If the pump was in disuse for a long period of time, circulate clean water through it for some minutes before restarting it to avoid incrustations.

4.8 DEMOLITION AND DISPOSAL

The Ruby 051-081 pump does not contain dangerous parts; however, when they are worn out, they must be disposed of in the following manner.

WARNING: Discharge any residual fluid from the pump. In case of dangerous, toxic fluids and/or otherwise noxious products, wash and treat as suitable: danger of injuries, damage to health and/or death.

1. Disconnect pneumatic supply from pump.
2. Disassemble and remove the pump from its position.
3. Separate elements according to type (see the pump's composition codes).

WARNING: For disposal please contact specialized disposal businesses and make sure that no small or large components are dispersed in the environment which may cause pollution, accidents or direct and/or indirect damage.

5.0 Troubleshooting

WARNING: For more serious problems, we strongly recommend that you contact the ALPHADYNAMIC SERVICE DEPARTMENT: our engineers will provide you assistance as quickly as possible.

Fault	Possible cause	Remedy
Pump running, no delivery	Pump draws in air Suction valve closed Suction capacity exceeded Valve ball and seat on suction side worn	Seal the suction line Open valves Change the arrangement Replace seats and balls
Insufficient pumping capacity	Muffler clogged Air inlet filter clogged Insufficient air supply Pipelines blocked Viscosity too high	Clean or renew Clean or renew Check supply line Clean Change conditions
Pump slows down, stops, restarts	Icing of the control valve	Use dry air Supply the air with anti-freeze
Reduced flow, stronger pulsation	Valve ball on suction side Blocked	Ensure movability of valve ball
Product from muffler	Diaphragm cracked	Replace diaphragm
Air in product	Diaphragm cracked	Replace diaphragm
Pump does not work despite air supply	Muffler clogged Air inlet filter clogged Valve balls sticking to valve seat	Clean or renew Clean or renew Loosen, use PTFE balls Instead
Valve balls deformed	Chemical attack Mechanical attack	Change material Change material
PTFE diaphragm cracked a after short time	Large solids in product Compressed air opened with a shock	Install a filter Install a slow start valve
Insufficient suction head	Valve ball and seat leaking Pump completely dry	Replace Fill suction line
Pump very loud, crackling noise	Control valve worn Excessive feed on the suction side	Replace Install heavier valve balls Throttling of suction line
Air valve Piston hard moving	Compressed air too dry (Instrument air) Temperature too high Compressed air dirty Air valve piston damaged	Lubricate the air Cool down Install a filter Replace
After filling the line pump standstill	Air pressure too low Too high viscosity Viscosity too high	Increase air pressure

6.0 Technical data

Ruby 051	
ATEX certification	II 3G Ex h IIB T4 Gc - II 3D Ex h IIIB T135 Dc
Construction materials	PP, PVDF, PP+CF
Diaphragms	NBR, EPDM, PTFE, SANTOPRENE, HYTREL
Intake/delivery connections	G 2"
Air connection	½"
Max. self-priming capacity	5 m
Max. flow rate	650 l/min
Max. head	70 m
Max. air supply pressure	7 bar
Max solid size (diameter)	8 mm
Max. operating temp.	PP 60°C, PVDF 95°C, P,P+CF 60°C
Weight PP	38 Kg
Weight PVDF	45 Kg

RUBY 081	
ATEX certification	II 3G Ex h IIB T4 Gc - II 3D Ex h IIIB T135 Dc
Construction materials	PP, PVDF, PP+CF
Diaphragms	NBR, EPDM, PTFE, SANTOPRENE, HYTREL
Intake/delivery connections	G 3"
Air connection	½"
Max. self-priming capacity	5 m
Max. flow rate	900 l/min
Max. head	70 m
Max. air supply pressure	7 bar
Max solid size (diameter)	10 mm
Max. operating temp.	PP 60°C, PVDF 95°C, P,P+CF 60°C
Weight PP	50 Kg
Weight PVDF	67 Kg

6.0 Technical data

6.1 Dimensional drawings

Ruby 051 Non Metallic

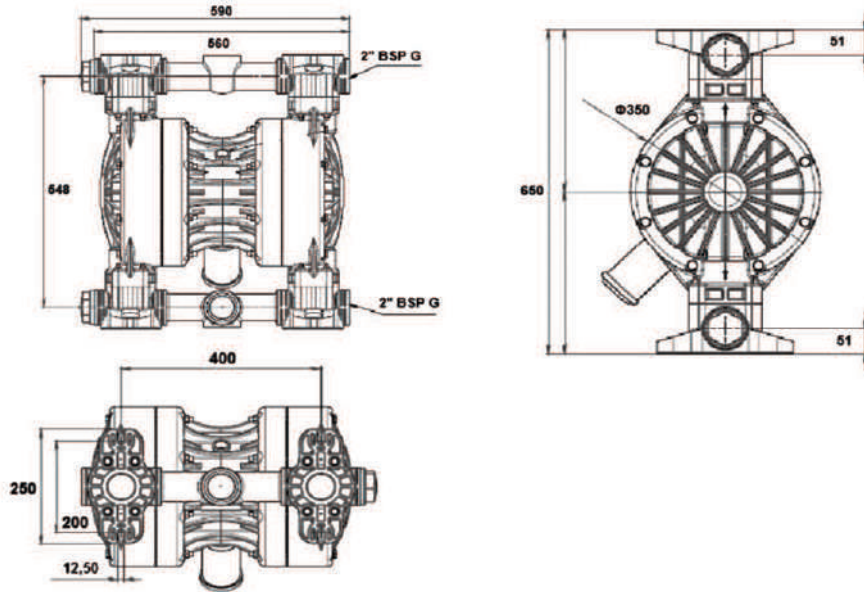

Ruby 081 Non Metallic

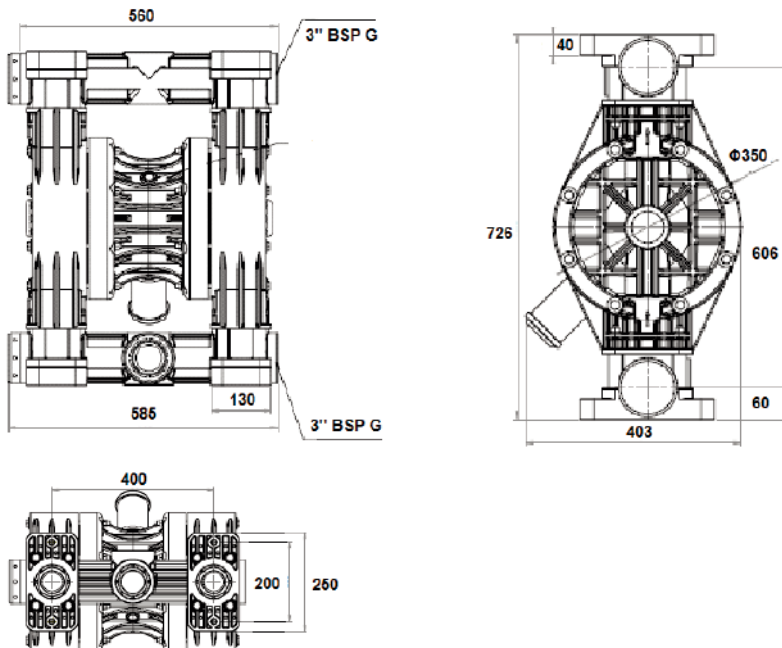

6.2 Performance

Ruby 051 Non Metallic

Flow. Rate.....650 L/min
 Air inlet1/2"
 Suction – Discharge port.....2" BSP G
 Suction lift (dry).....5m
 Max. Solid size (diameter).....8 mm

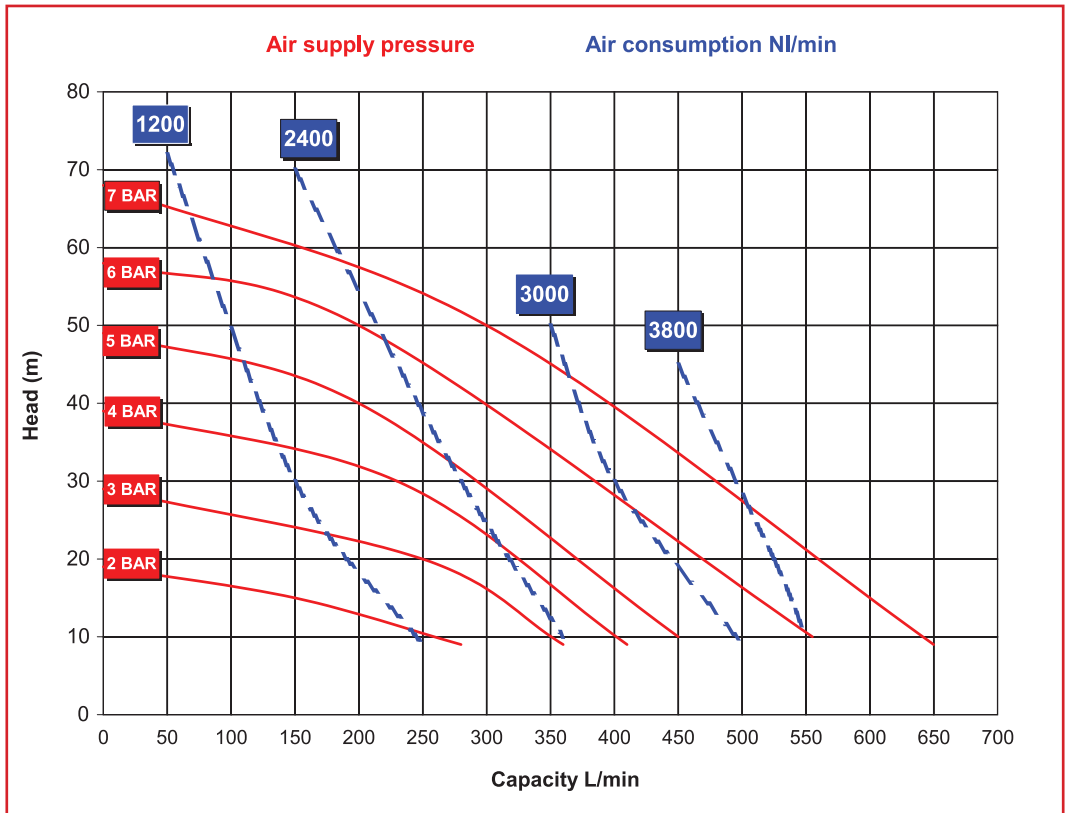

* The curves and performance values refer to pumps with submerged suction and a free delivery outlet with water at 20°C, and vary according to the construction material.

Ruby 081 Non Metallic pump

Flow. Rate900 L/min
 Air inlet3/4"
 Suction – Discharge port3 " BSP G
 Suction lift (dry).....5m
 Max. Solid size (diameter)8 mm

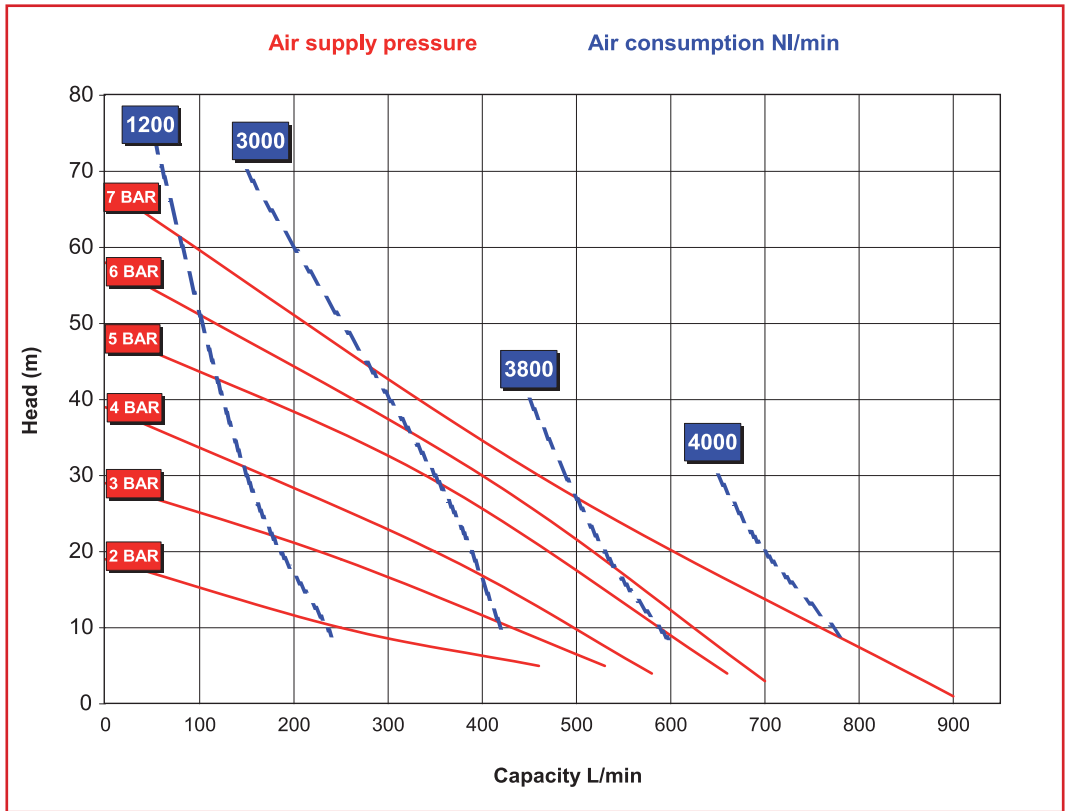

* The curves and performance values refer to pumps with submerged suction and a free delivery outlet with water at 20°C, and vary according to the construction material.

Exploded view
 6.3.1 Exploded view
 Ruby 051 Non Metallic



051 PP-PVDF spare part list pump

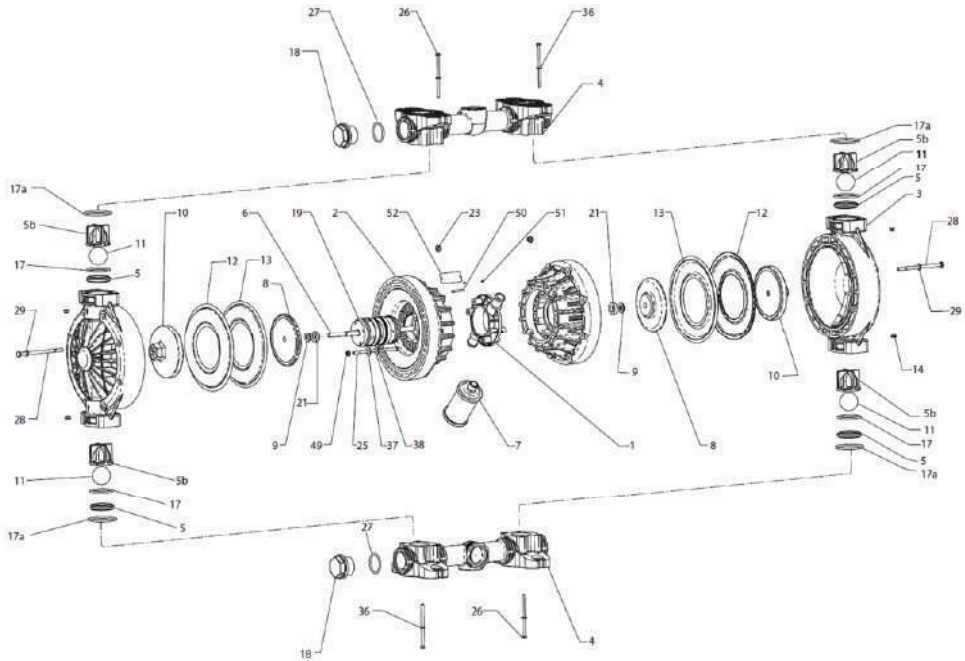

POS	DESCRIPTION	QTY	POS	DESCRIPTION	QTY
01	CENTRAL BLOCK	1	19	AIR CONTROL UNIT	20
02	FLANGE	2	21	SPACER	36
03	PUMP HOUSING	2	23	BOLT	8
04	MANIFOLD	2	25	CENTRAL SCREW	54
05	BALL SEAT	4	26	PUMP HOUSING SCREW	8
05b	BALL RUNNER CAGE	4	27	MANIFOLD CAP ORING	2
06	SHAFT	1	28	MANIFOLD SCREW	4
07	SILENCER	1	29	WASHER	2
08	INTERNAL CAP	2	36	WASHER	4
09	WASHER	1	37	WASHER	2
10	CAP	8	47	FLANGER NUT	2
11	BALL	1	48	PIN	
12	INTERNAL DIAPHRAGM	2			
13	EXTERNAL DIAPHRAGM	2			
17	BALL SEAT PACKING LOW	4			
17a	BALL SEAT PACKING UP	2			
18	MANIFOLD CAP	1			

Ruby 081 Non metallic



081 PP-PVDF spare part list pump

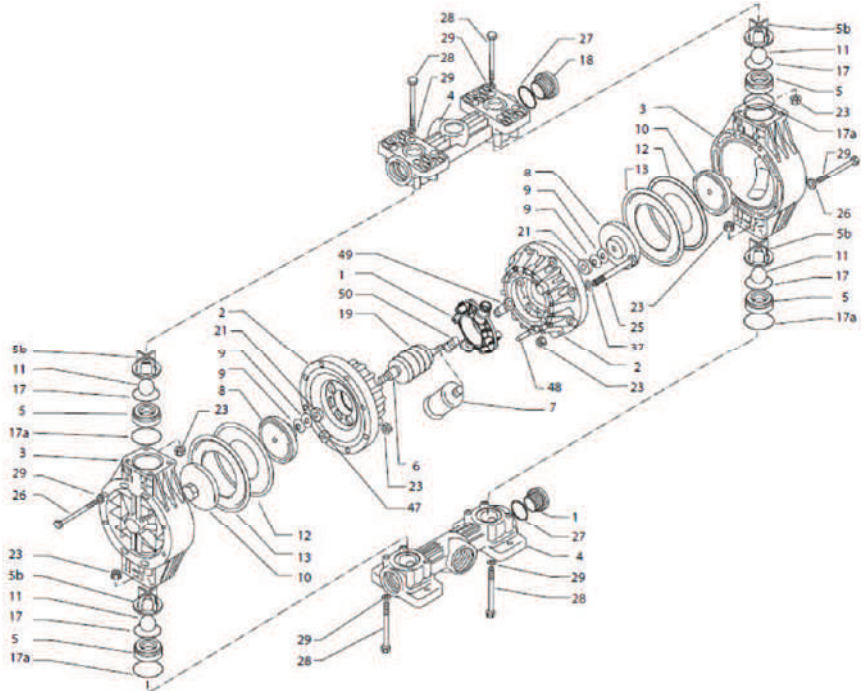

POS	DESCRIPTION	QTY	POS	DESCRIPTION	QTY
01	CENTRAL BLOCK	1	19	AIR CONTROL UNIT	1
02	FLANGE	2	21	SPACER	2
03	PUMP HOUSING	2	23	BOLT	16
04	MANIFOLD	2	25	CENTRAL SCREW	8
05	BALL SEAT	4	26	PUMP HOUSING SCREW	16
05b	BALL RUNNER CAGE	4	27	MANIFOLD CAP ORING	2
06	SHAFT	1	28	MANIFOLD SCREW	16
07	SILENCER	1	29	WASHER	16
08	INTERNAL CAP	2	37	WASHER	8
09	WASHER	4	47	FLANGER NUT	8
10	CAP	2	48	PIN	12
11	BALL	4			
12	INTERNAL DIAPHRAGM	2			
13	EXTERNAL DIAPHRAGM	2			
17	BALL SEAT PACKING	4			
17a	BALL SEAT PACKING UP	4			
18	MANIFOLD CAP	2			

6.3.2 Spare part list

Ruby 051 Spares PP-PVDF



POSITION	Part No	DESCRIPTION	No req.
51.01	R051-3011	CENTRAL HOUSING PP	1
51.02	R051-3012	FLANGE AIR SIDE PP	2
51.02	R051-3013	FLANGE AIR SIDE PP+CF	2
51.03	R051-4029	PUMP CASING PP	2
51.03	R051-4030	PUMP CASING PP+CF	2
51.03	R051-4031	PUMP CASING PVDF+CF	2
51.04	R051-4032	MANIFOLD PVDF	2
51.04	R051-4033	MANIFOLD PP+CF	2
51.04	R051-4034	MANIFOLD PP	2
51.05	R051-3104	BALL SEAT PP	4
51.05	R051-4036	BALL SEAT PVDF	4
51.05b	R051-4037	BALL RUNNER CAGE PP	4
51.05b	R051-4038	BALL RUNNER CAGE PVDF+CF	4
51.06	R051-3123	CONNECTION SHAFT	1
51.07	R050-0140	SILENCER	1
51.08	R051-3131	INTERNAL CAP	2
51.09	R051-3134	BELLEVILLE WASHER	4
51.10	R051-3160	EXTERNAL CAP PP+CF	2
51.10	R051-3161	EXTERNAL CAP PVDF	2
51.10	R051-3162	EXTERNAL CAP PP	2
51.11	R051-0062	BALL PTFE	4
51.11	R050-0121	BALL EPDM	4
51.11	R050-0123	BALL NBR	4
51.12	R050-0124	BALL AISI 316	4
51.12	R051-0001	INTERNAL DIAPHRAGM HYTREL	2
51.12	R051-0002	INTERNAL DIAPHRAGM SANTOPRENE	2
51.12	R051-0170	INTERNAL DIAPHRAGM EPDM	2
51.12	R051-3179	INTERNAL DIAPHRAGM NBR	2
51.13	R051-0063	EXTERNAL DIAPHRAGM PTFE	2
51.17	R051-4040	BALL SEAT PACKING NBR	4
51.17	R051-4041	BALL SEAT PACKING EPDM	4
51.17	R051-3239	BALL SEAT PACKING VITON	4
51.17	R051-3226	BALL SEAT PACKING PTFE	4
51.17a	R051-4043	BALL SEAT PACKING NBR	4
51.17a	R051-4044	BALL SEAT PACKING EPDM	4
51.17a	R051-4045	BALL SEAT PACKING VITON	4
51.17a	R051-3240	BALL SEAT PACKING PTFE	4
51.18	R051-4047B	MANIFOLD CAP PP	2
51.18	R051-4048	MANIFOLD CAP PVDF	2
51.18	R051-4049	MANIFOLD CAP PP+CF	2
51.19	R051-3268	AIR CONTROL UNIT	1
51.21	R051-4050	SPACER	2
51.23	R080-0197A	BOLT	16
51.25	R051-3287	CENTRAL SCREW	8
51.26	R051-4053	MANIFOLD SCREW	16
51.27	R051-3326	MANIFOLD CAP PACKING EPDM	2
51.27	R051-3327	MANIFOLD CAP PACKING VITON	2
51.27	R051-3328	MANIFOLD CAP PACKING PTFE	2
51.28	R051-4056	PUMP CASING SCREW	16
51.29	R051-3336	WASHER M 10*30	16
51.36	R040-0198A	WASHER M 8*16	16
51.37	R051-4059	WASHER M 8X24X2	8
51.47	R040-0197A	BOLT M8	8
51.48	R051-3387	PIN	12

**Ruby 081 Spares
PP-PVDF**



POSITION	Part No	DESCRIPTION	No req.
81.01	R051-3011	CENTRAL HOUSING PP	1
81.02	R051-3012	FLANGE AIR SIDE PP	2
81.02	R051-3013	FLANGE AIR SIDE PP+CF	2
81.03	R081-4029	PUMP CASING PP	2
81.03	R081-3050	PUMP CASING PP+CF	2
81.03	R081-3051	PUMP CASING PVDF+CF	2
81.04	R081-3083	MANIFOLD PVDF	2
81.04	R081-3084	MANIFOLD PP+CF	2
81.04	R081-4034	MANIFOLD PP	2
81.05	R081-3104	BALL SEAT PP	4
81.05	R081-3105	BALL SEAT PVDF	4
81.05b	R081-4037	BALL RUNNER CAGE PP	4
81.05b	R081-3116	BALL RUNNER CAGE PVDF+CF	4
81.06	R051-3123	CONNECTION SHAFT	1
81.07	R050-0140	SILENCER	1
81.08	R051-3131	INTERNAL CAP	2
81.09	R051-3134	BELLEVILLE WASHER	4
81.10	R051-3160	EXTERNAL CAP PP+CF	2
81.10	R051-3161	EXTERNAL CAP PVDF	2
81.10	R051-3162	EXTERNAL CAP PP	2
81.11	R081-0062	VALVE BALL PTFE	4
81.11	R080-0121	VALVE BALL EPDM	4
81.11	R080-0123	VALVE BALL NBR	4
81.12	R051-0001	INTERNAL DIAPHRAGM HYTREL	2
81.12	R051-0002	INTERNAL DIAPHRAGM SANTOPRENE	2
81.12	R051-0170	INTERNAL DIAPHRAGM EPDM	2
81.12	R051-3179	INTERNAL DIAPHRAGM NBR	2
81.13	R051-0063	EXTERNAL DIAPHRAGM PTFE	2
81.17	R081-3222	BALL SEAT PACKING EPDM (PLASTIC)	4
81.17	R081-3223	BALL SEAT PACKING VITON	4
81.17a	R081-3236	BALL SEAT PACKING EPDM	4
81.17a	R081-3237	BALL SEAT PACKING VITON	4
81.18	R081-3265	MANIFOLD CAP PP	2
81.18	R081-3266	MANIFOLD CAP PVDF	2
81.18	R081-3267	MANIFOLD CAP BLACK	2
81.19	R051-3268	AIR CONTROL UNIT	1
81.21	R051-4050	SPACER	2
81.23	R040-0197A	FLANGED NUT	24
81.25	R051-3287	CENTRAL SCREW	8
81.26	R081-3302	PUMP CASING SCREW	16
81.27	R081-3329	MANIFOLD CAP PACKING EPDM	2
81.27	R081-3330	MANIFOLD CAP PACKING VITON	2
81.28	R051-4056	MANIFOLD SCREW	16
81.29	R051-3336	WASHER M 10*30	16
81.29	R081-3336B	WASHER M 10*20	16
81.37	R051-4059	WASHER M 8X24X2	8
81.47	R040-0197A	BOLT M8	8
81.48	R051-3387	PIN	4



ALPHADYNAMIC PUMPS

Industrial Park of Kifisia - HELLAS

Air Operated Diaphragm Pumps

<https://prom-nasos.pro>

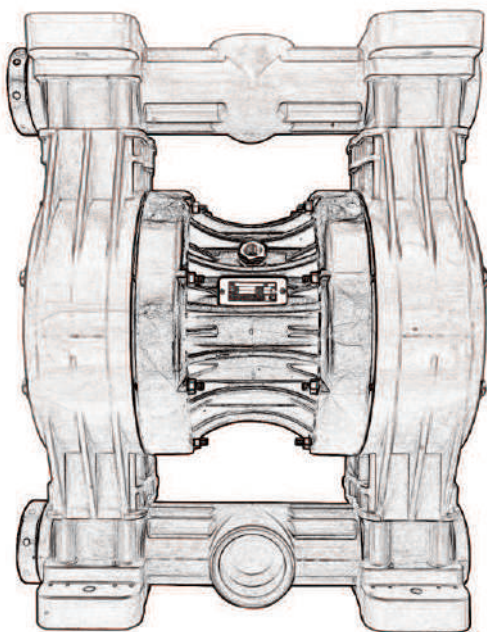
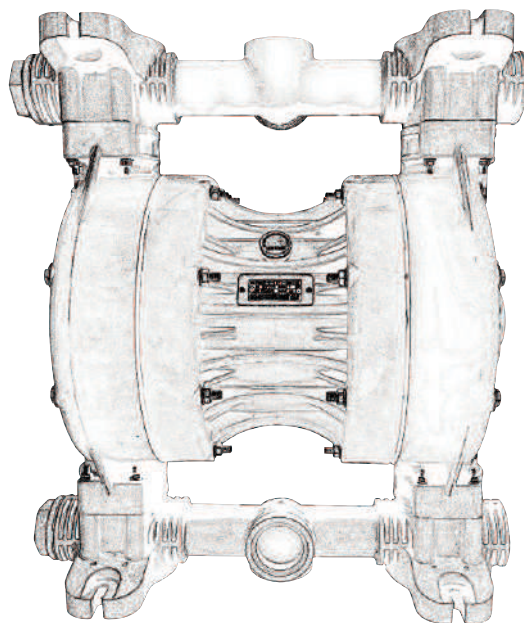

VER. 02.2021



BTS
ENGINEERING
<https://prom-nasos.pro>
<https://bts.net.ua>
<https://prom-nasos.com.ua>
+38 095 656-37-57
+38 067 360-71-01
+38 063 362-12-31
info@prom-nasos.pro