

50Hz

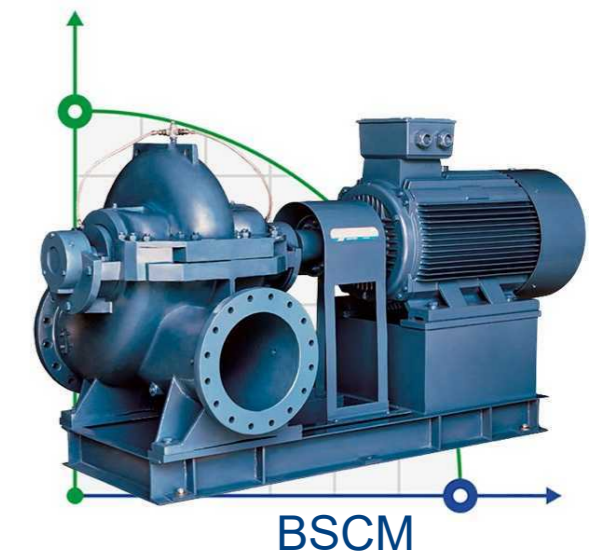

BSC/BSCM Double suction split case pump
BSC/BSCM Succión doble bomba de cámara partida
BSC/BSCM Pompe à double corps d'aspiration

BTS
ENGINEERING

<https://prom-nasos.pro>
<https://bts.net.ua>
<https://prom-nasos.com.ua>

+38 095 656-37-57,
+38 067 360-71-01,
+38 063 362-12-31,
info@prom-nasos.pro

<https://bts.net.ua>



BSC/BSCM

Double suction split case pump

Succión doble bomba de cámara partida

Pompe à double corps d'aspiration



TECHNICAL DATA/DATOS TÉCNICOS/DONNÉES TECHNIQUES

BSC4 50 Hz n=1450 1/min

BSC 50 Hz n=2900 1/min

MODEL MODELO MODÈLE	Flow Range Rango de Caudal Gamme de débit m³/h	Head Range Rango de Altura Gamme de tête m	Power Range Rango de Potencia Gamme de puissance kw	DN mm
80-210A1	131-164-197	60.5-55-50	26.8-29.9-33.4	125x80
80-210A2	121-151-181	52-47.5-42.2	21.6-24.1-26.1	125x80
80-210A3	115-144-173	44-39-35	17.8-19-21.1	125x80
80-210A4	110-137-164	37-33.5-27.7	14.7-16-16.7	125x80
80-210B1	107-134-160	55.5-51-46	20.5-22.9-25.1	125x80
80-210B2	106-133-159	47.7-43.5-37	17.6-19.3-20	125x80
80-210B3	100-124-149	40-36-30	14.4-15.6-16.5	125x80
80-210B4	91-113-136	35-31-27	12.1-12.9-13.9	125x80
80-270A1	166-207-248	97.5-90-79	57-64.6-70.8	125x80
80-270A2	156-194-233	83.5-77-69	46.6-52.6-58.1	125x80
80-270A3	147-184-220	70-63.5-55	37.5-41.8-44.6	125x80
80-270A4	138-173-198	56.5-50-45	28.7-31.4-32.8	125x80
80-270B1	137-171-205	91-82.5-72.5	44.6-49.9-54.1	125x80
80-270B2	122-153-184	79.5-71.5-67	35.6-39.1-44.7	125x80
80-270B3	115-144-173	66.8-60-53	28.5-31.3-33.7	125x80
80-270B4	110-137-164	54.5-49-42	22.4-24.5-25.9	125x80
100-250A1	230-288-346	83-75-67	64.2-70.9-78.4	150x100
100-250A2	219-274-328	69-63-55	51.9-58.3-62.3	150x100
100-250A3	209-261-313	59-52-46.5	43.5-46.8-51.5	150x100
100-250A4	193-240-290	49-45-37	33.9-37.7-39.2	150x100
100-250B1	196-245-294	75-68-59	50-55.6-59.8	150x100
100-250B2	180-223-268	65-59-51	40.6-44.7-47.9	150x100
100-250B3	165-205-246	56-51-44	32.9-36.8-38.8	150x100
100-250B4	150-190-227	48-43-38	26.4-29.1-31.1	150x100
100-310A1	294-367-440	135-123-105	137.7-153.8-164	150x100
100-310A2	268-335-402	116-106-92	108-121.4-131	150x100
100-310A3	242-302-363	98-90-80	82.7-93.5-102.5	150x100
100-310A4	182-227-333	86-81-63	62-68-76	150x100
100-310B1	226-283-340	130-119-105	105-117.4-128.5	150x100
100-310B2	208-260-310	111-103-90	81.8-93.7-100	150x100
100-310B3	200-250-300	92-84-74	65.8-72.8-80.5	150x100
100-310B4	187-234-281	78-69-60	53.1-57.1-61.2	150x100
125-230A1	426-541-639	68-60-48	93.8-101.8-101.9	200x125
125-230A2	392-490-585	60-52-43.5	78.1-82.1-84.4	200x125
125-230A3	363-454-544	50-43.5-35	63.4-65.1-66.6	200x125
125-230A4	340-425-489	40-34-30	49.4-50.8-52.5	200x125
125-230B1	377-472-566	68-60.5-51	84.2-92-101.5	200x125
125-230B2	349-436-523	60-53-44	70.3-74.8-77.2	200x125
125-230B3	328-410-493	52-45-37	60.1-61.3-63.3	200x125
125-230B4	305-382-458	42.5-37-30	47.1-49.9-49.9	200x125
125-290A1	428-535-642	117-108-95	166-187-202	200x125
125-290A2	397-497-596	97-88-75	131-145-153	200x125
125-290A3	363-454-544	80-72-62	101-111-117	200x125
125-290A4	323-403-484	65-57-47	74.7-80.2-80.5	200x125
125-290B1	383-480-575	113-100-85.5	145-157-166	200x125
125-290B2	348-436-523	93.5-83.5-70	112-121-126	200x125
125-290B3	308-385-462	78-70-60	84.5-93-96.9	200x125
125-290B4	274-342-410	60-55-47	59.6-67.4-70	200x125

MODEL MODELO MODÈLE	Flow Range Rango de Caudal Gamme de débit m³/h	Head Range Rango de Altura Gamme de tête m	Power Range Rango de Potencia Gamme de puissance kw	DN mm
80-210A1	66-83-100	15-13.8-12.2	3.4-3.8-4.2	125x80
80-210A2	61-76-90	13-11.8-10.5	2.7-3-3.3	125x80
80-210A3	58-72-87	11-9.8-8.7	2.2-2.4-2.6	125x80
80-210A4	55-69-83	9.1-8.2-7	1.8-2-2.1	125x80
80-210B1	52-65-78	14.2-12.8-10	2.6-2.8-3.1	125x80
80-210B2	52-64-77	12-10.8-11.7	2.1-2.4-3.1	125x80
80-210B3	50-61-73	10-9-7.8	1.8-1.9-2	125x80
80-210B4	47-58-70	8.7-7.6-6.5	1.5-1.6-1.8	125x80
80-270A1	83-104-125	24-22.5-19.5	7-8.1-8.8	125x80
80-270A2	80-99-120	21.3-19-17	6.1-6.6-7.4	125x80
80-270A3	72-90-108	17.5-16-13.7	4.6-5.2-5.4	125x80
80-270A4	67-84-100	13.8-13-11.5	3.4-4-4.3	125x80
80-270B1	68-85-102	23.1-20.7-18.2	5.7-6.2-6.7	125x80
80-270B2	61-77-92	20-18.1-16	4.5-5-5.3	125x80
80-270B3	58-72-86	16.5-15-13.2	3.5-3.9-4.2	125x80
80-270B4	53-67-80	13.8-12.5-10.8	2.7-3.1-3.2	125x80
80-370A1	90-113-136	42-38.8-33.5	14.8-16.2-17.3	125x80
80-370A2	80-99-120	35-33-29.1	10.6-12.1-13.3	125x80
80-370A3	70-88-106	29.3-27.5-24.7	8.2-9.4-10.2	125x80
80-370A4	65-81-98	23.8-22.5-20	6.4-7.4-8	125x80
80-370B1	80-99-120	38.8-35.5-31.3	11.8-13.1-14.3	125x80
80-370B2	72-90-108	34.1-30.8-26.3	9.7-10.8-11.4	125x80
80-370B3	60-76-90	27.5-25.5-22.5	7-8-8.5	125x80
80-370B4	53-67-80	21.3-20-17.5	4.9-5.7-6	125x80
100-250A1	115-144-173	21.2-18.8-17.5	8.2-8.9-10	150x100
100-250A2	112-140-167	17.5-15.8-13.2	6.7-7.4-7.7	150x100
100-250A3	100-126-150	14.5-13.5-11.9	5.1-5.9-6.3	150x100
100-250A4	97-120-145	12.2-11.2-9.5	4.2-4.7-5	150x100
100-250B1	98-122-147	18.8-17-15	6.2-7-7.6	150x100
100-250B2	90-112-135	16.3-14.5-12.7	5.1-5.6-6	150x100
100-250B3	85-106-128	13.7-12.5-11.3	4.1-4.7-5.3	150x100
100-250B4	75-94-113	12.1-11-9.6	3.3-3.7-3.9	150x100
100-310A1	148-185-222	34-31-26.8	17.4-19.6-21	150x100
100-310A2	133-166-200	29.3-27-24.3	13.4-15.3-17	150x100
100-310A3	120-151-180	24.8-22.5-20	10.5-11.7-12.8	150x100
100-310A4	112-140-162	20.2-18.5-16.2	7.9-9-9.2	150x100
100-310B1	112-140-168	32.5-29.5-25	13-14.1-15.5	150x100
100-310B2	106-133-160	27.5-25.5-22	10.4-11.6-12.8	150x100
100-310B3	100-124-150	23-21.2-18	8.2-9-9.8	150x100
100-310B4	94-117-140	19.4-17-15	6.5-6.9-7.6	150x100
100-375A1	148-185-220	57-51-44.2	31.4-33.5-36	150x100
100-375A2	133-167-200	47.3-46-38	24.5-28.3-29.2	150x100
100-375A3	124-155-186	41-38-31	20.3-22.6-23.1	150x100
100-375A4	108-135-162	32.5-30.3-25.3	14.4-14.5-16.8	150x100
100-375B1	130-162-195	56.2-52-45.8	28.4-31.4-35.9	150x100
100-375B2	114-142-170	47.5-44-39	22.2-23.7-27.3	150x100
100-375B3	105-130-157	40-37.5-32.5	17.7-18.8-21.7	150x100
100-375B4	92-115-138	30.8-28.7-25	12.7-14.3-15.4	150x100

NEW/NUEVO/NOUVEAU

DESCRIPTION/DESCRIPCIONES/DESCRIPTION

- ♦ Axially split volute pump casing design
 - ♦ Pump case with anti-corrosive coating HT250
 - ♦ Double-entry radial impeller in AISI 304 or HT250
 - ♦ Shaft protecting sleeves in the seal area
 - ♦ Mechanical seal and gland packing are both available
 - ♦ Grease-packed rolling element bearings sealed for life
 - ♦ Reliable complete with motor or diesel for fire fighting etc.
- ♦ *Diseño de carcasa de bomba de voluta dividida axialmente*
 - ♦ *Caja de bomba con recubrimiento anticorrosivo HT250*
 - ♦ *Impulsor radial de doble entrada en inox304 o HT250*
 - ♦ *Mangas de protección del eje en el área del sello*
 - ♦ *El sello mecánico y el empaque de la glándula están disponibles*
 - ♦ *Rodamientos de elementos rodantes rellenos de grasa*
 - ♦ *Completamente confiable con motor o diesel para incendios etc.*
- ♦ *Conception de corps de pompe à volute divisée axialement*
 - ♦ *Carter de pompe avec revêtement anti-corrosif HT250*
 - ♦ *Roue radiale à double entrée en inox304 ou HT250*
 - ♦ *Manchons de protection d'arbre dans la zone d'étanchéité*
 - ♦ *Le joint mécanique et le presse-étoupe sont disponibles*
 - ♦ *Roulements d'éléments roulants graissés scellés à vie*
 - ♦ *Fiable complet avec moteur ou diesel pour la lutte l'incendie etc.*

USING LIMITS/LÍMITES UTILIZACIÓN/UTILISATION LIMITES

- ♦ Liquid temperature between **-10°C** and **+120°C**
 - ♦ Ambient temperature between **0°C** and **+50°C**
 - ♦ Max. working pressure **25 bar/Continuous S1**
- ♦ *Temperatura del líquido de -10 °C hasta +120 °C*
 - ♦ *Temperatura ambiente de 0 °C hasta +50 °C*
 - ♦ *Presión máxima 25 bar/Continuo S1*
- ♦ *Température du liquide entre -10 °C et +120 °C*
 - ♦ *Température ambiante entre 0 °C et +50 °C*
 - ♦ *Max. pression de service 25 bar/Continu S1*

MODEL CODE/CÓDIGO MODELO/CODE MODÈLE

For example/Par ejemplo/Par exemple

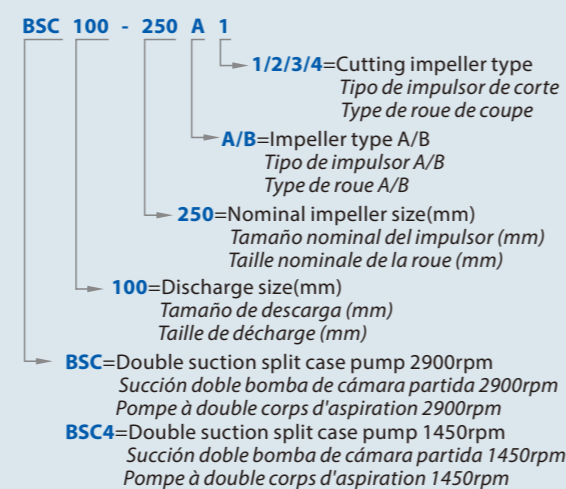

BSC4 50 Hz n=1450 1/min

MODEL MODELO MODÈLE	Flow Range Rango de Caudal Gamme de débit m³/h	Head Range Rango de Altura Gamme de tête m	Power Range Rango de Potencia Gamme de puissance kw	DN mm
125-230A1	220-274-328	17-14.8-12	12.1-12.9-13.1	200x125
125-230A2	193-241-290	15-13.2-10.8	9.7-10.3-10.4	200x125
125-230A3	184-230-277	12.6-10.6-8	8-8.1-8.1	200x125
125-230A4	167-209-250	10.3-8.7-6.8	6.4-6.4-6.4	200x125
125-230B1	190-238-307	17-15.1-11.5	10.5-11.6-12	200x125
125-230B2	170-212-255	15-13.5-11.4	8.6-9.3-9.7	200x125
125-230B3	164-205-246	13-11.5-9.2	7.5-7.8-7.9	200x125
125-230B4	156-195-223	10.5-9.1-7.7	5.9-6.2-6.3	200x125
125-290A1	215-269-323	29.2-27-23.5	20.8-23.6-25.2	200x125
125-290A2	195-243-292	24.4-22-19.6	16.1-17.8-19.5	200x125
125-290A3	178-223-268	20-18-15.5	12.3-13.7-14.4	200x125
125-290A4	161-202-242	16.3-14.2-11.8	9.3-10-10.2	200x125
125-290B1	193-241-290	27.5-25-21.3	17.8-19.8-20.6	200x125
125-290B2	174-218-261	23.4-21-17.5	13.9-15.2-16	200x125
125-290B3	157-196-235	19-17.5-15	10.4-11.8-12.3	200x125
125-290B4	138-173-207	15.1-13.7-11.3	7.7-8.5-8.6	200x125
125-365A1	245-310-360	50-47-44	41.2-47.2-52.3	200x125
125-365A2	225-281-337	41.6-39-35.6	31.8-36-40.4	200x125
125-365A3	205-256-307	33.7-31.5-28.2	24.2-26.8-29.8	200x125
125-365A4	184-230-278	25.5-24-20.9	16.9-18.8-20.2	200x125
125-365B1	222-277-333	46.3-43-38.8	35.4-40.1-44	200x125
125-365B2	202-252-302	39.8-37-32.8	28-31.8-34.2	200x125
125-365B3	182-227-272	32.6-30.5-27.5	21.4-24.5-26.8	200x125
125-365B4	158-198-238	26.3-24.5-21.8	14.9-17.4-18.8	200x125
125-500A1	262-328-393	82-76-70	73.7-82.7-96.4	200x125
125-500A2	233-292-342	70-66.5-62	56.7-67.3-74.8	200x125
125-500A3	205-256-307	60-56-51.5	44-50.6-56.6	200x125
125-500A4	184-230-252	50-47-45	34.2-38.8-40.7	200x125
125-500B1	235-293-352	75-69.5-63	61.7-70.3-78.5	200x125
125-500B2	217-272-326	65-60.5-55	50.1-57.4-64.3	200x125
125-500B3	181-227-272	57-53-48.3	37.5-42.5-47.3	200x125
125-500B4	161-202-234	47.5-45-40	28.2-32.5-34.5	200x125
150-290A1	354-443-531	24-21-17.5	27.1-29.1-30.3	200x150
150-290A2	323-403-484	21-18-15	22.2-23-24	200x150
150-290A3	302-378-454	17.5-15-12.3	18-18.4-19.1	200x150
150-290A4	280-350-396	13.7-11.5-10	13.9-14.2-14.2	200x150
150-290B1	317-396-475	23.4-20.4-16.6	24-25.6-25.7	200x150
150-290B2	302-378-454	20-17-13.7	19.9-20.6-20.7	200x150
150-290B3	282-353-423	17.5-14.5-11.3	16.6-16.6-16.5	200x150
150-290B4	265-331-378	14-11.5-9.8	13-13-13.3	200x150
150-360A1	357-446-536	41.3-38-34.2	48.4-54.3-60.4	200x150
150-360A2	323-403-484	34.2-31-26.3	36.9-41-42.9	200x150
150-360A3	298-370-445	28.7-25-21	29.4-31.2-32.3	200x150
150-360A4	265-331-398	23.4-20-16.7	22.1-23.1-23.3	200x150
150-360B1	325-407-488	39.2-35-30	42.3-46.2-49.3	200x150
150-360B2	294-367-440	33-29.5-25	32.8-36-37.5	200x150
150-360B3	267-334-400	27.5-25-21.3	25.4-28.5-29.8	200x150
150-360B4	233-292-350	22.8-20.5-17.5	19.2-20.9-22	200x150
150-460A1	412-515-618	71-66-60	99.4-112.8-126.2	200x150
150-460A2	377-472-566	58-54.5-48	75.2-86.4-94.9	200x150
150-460A3	346-432-516	47.5-43.5-37	57-64-69.7	200x150
150-460A4	317-396-475	38-35-28.2	42.6-48.1-50.7	200x150
150-460B1	350-440-527	65-60-53.5	78.3-88.6-97.6	200x150
150-460B2	323-403-484	54-50-44.5	60.3-68.2-75.2	200x150
150-460B3	300-375-450	44.4-40-34.5	46.5-51-57.1	200x150
150-460B4	260-324-390	35.6-33-28.4	33.5-37.3-40.7	200x150
150-605A1	467-583-700	112-105-95.5	182.6-206-233.4	200x150
150-605A2	440-550-648	96-88.5-81	151.1-168-187.5	200x150
150-605A3	412-515-605	82-75-68	120-134.8-151.4	200x150
150-605A4	378-472-526	67.5-61.5-55.2	92.3-102.6-106.8	200x150

BSC4 50 Hz n=1450 1/min

MODEL MODELO MODÈLE	Flow Range Rango de Caudal Gamme de débit m³/h	Head Range Rango de Altura Gamme de tête m	Power Range Rango de Potencia Gamme de puissance kw	DN mm
150-605B1	430-536-617	98-90-82	149.2-166.4-181.5	200x150
150-605B2	392-490-576	85-78-70	118.9-133.3-148.1	200x150
150-605B3	357-446-535	75-68.5-60	96.2-108.2-118.4	200x150
150-605B4	323-403-484	62.5-57.5-50	73.4-83.1-91.6	200x150
200-320A1	556-695-834	34-30-25	60-64.9-67.2	250x200
200-320A2	518-648-778	29-25.5-21.3	48.8-52-54	250x200
200-320A3	481-601-720	25-21.3-17.2	40.7-41-42.3	250x200
200-320A4	440-550-612	18.9-17-15.3	29-32.3-32.9	250x200
200-320B1	510-637-765	32.3-28-23.4	52.7-56.2-58	250x200
200-320B2	475-594-713	28.5-24.5-20	44-46.1-46.9	250x200
200-320B3	445-558-670	23.8-21-17.2	35.6-38-38.4	250x200
200-320B4	412-515-595	20-17-14.2	28.8-29.1-29.5	250x200
200-420A1	567-709-850	57-52-47	104-116-129	250x200
200-420A2	504-630-756	47.5-42.5-37.5	79.1-86.3-93.1	250x200
200-420A3	458-572-687	40-35.5-30	62-66.7-68.8	250x200
200-420A4	409-511-613	32.5-27.5-24	45.8-49-50.1	250x200
200-420B1	518-648-778	54-48.5-42	90.8-99.1-107	250x200
200-420B2	467-583-700	45-40.5-35	69.8-76.6-81.9	250x200
200-420B3	423-530-635	38-34.5-29	54.8-60.6-63.1	250x200
200-420B4	375-468-562	31.5-28-24	41.5-45.8-47.5	250x200
200-520A1	654-817-980	97-91-83	210-241-272	250x200
200-520A2	605-756-907	82.5-76.5-70	170-192-215	250x200
200-520A3	565-706-847	67-62.5-55	132-148-163	250x200
200-520A4	518-647-778	52.3-47.5-42	98-107-117	250x200
200-520B1	558-734-880	88-81.7-73.2	175-197-219	250x200
200-520B2	556-695-834	74-68-60	141-159-172	250x200
200-520B3	524-655-786	60-55-48.8	109-123-134	250x200
200-520B4	478-598-717	48-43.5-38	81-91-98	250x200
200-670A1	634-792-936	157.5-150-140	350-404-457	250x200
200-670A2	596-745-894	134.5-127-114.5	285-328-367	250x200
200-670A3	562-702-842	114.5-107-95.5	231-266-293	250x200
200-670A4	527-659-770	95.5-88-80	183-208-227	250x200
200-670B1	576-720-864	142-132.5-120	289-329-372	250x200
200-670B2	530-662-795	123-114.5-104	231-263-296	250x200
200-670B3	493-616-720	106-98.5-90	187-212-232	250x200
200-670B4	455-569-683	90-83-73	149-167-184	250x200
250-370A1	840-1051-1260	44-39-33.5	118-127-137	300x250
250-370A2	795-994-1192	37.5-33-27.7	99-104-109	300x250
250-370A3	755-943-1131	31.5-27-21	83-83.6-83.6	300x250
250-370A4	756-871-1008	23-20-16	62.3-61.2-57.8	300x250
250-370B1	823-1029-1235	42.3-37-31	112-119-124	300x250
250-370B2	775-968-1162	37-32-27	94.9-98.1-103.6	300x250
250-370B3	732-914-1097	32-27-22	79.7-80-82.2	300x250
250-370B4	680-850-1020	25.6-22-17	61.6-62.1-61.3	300x250
250-480A1	938-1173-1408	73.5-66-58	222-239-262	300x250
250-480A2	864-1080-1296	60.5-55-47.5	166-188-202	300x250
250-480A3	800-1000-1200	50-45.5-38	136-149-160	300x250
250-480A4	743-929-1115	42-37.5-32	110-119-126	300x250
250-480B1	864-1044-1296	62-55.5-45	177-191-199	300x250
250-480B2	780-976-1171	53.5-47-42	141-149-163	300x250
250-480B3	708-886-1063	45-40.5-34	111-121-126	300x250
250-480B4	642-803-963	40-34.5-28.5	94.6-96.1-98.4	300x250
250-600A1	994-1242-1490	126-116-105	411-467-520	300x250
250-600A2	933-1166-1400	108-100-90	333-380-421	300x250
250-600A3	867-1084-1300	90-83-73.5	262-295-322	300x250
250-600A4	800-1000-1200	74-66-60	201-218-244	300x250
250-600B1	835-1044-1253	114-104-91.5	320-356-381	300x250
250-600B2	772-965-1158	98-90-80	255-287-311	300x250
250-600B3	700-875-1050	80.3-74.5-66	192-218-235	300x250
250-600B4	640-800-960	67.5-62-56.5	149-168-186	300x250

BSC4 50 Hz n=1450 1/min

MODEL MODELO MODÈLE	Flow Range Rango de Caudal Gamme de débit m³/h	Head Range Rango de Altura Gamme de tête m	Power Range Rango de Potencia Gamme de puissance kw	DN mm
250-710A1	904-1130-1356	184-175-164	579-674-775	300x250
250-710A2	782-978-1174	161-152-141	444-513-578	300x250
250-710A3	738-922-1106	136-128-118	358-415-465	300x250
250-710A4	692-865-1038	113-106-99	280-325-360	300x250
300-300A1	878-1098-1318	28.8-24.5-20	83.8-85.2-89.4	350x300
300-300A2	835-1044-1253	23.5-19.8-15	66.4-66.6-63.2	350x300
300-300A3	806-1008-1210	19-15.5-11.4	52.8-51.9-48.2	350x300
300-300A4	772-965-1158	15-11.5-7.5	41.5-37.8-32	350x300
300-300B1	745-936-1123	26.2-23-20	64.4-69-72.9	350x300
300-300B2	691-864-1037	24-20-15.8	56.2-56-55.1	350x300
300-300B3	639-800-960	20-16.7-13.5	45.5-44.9-44.6	350x300
300-300B4	560-700-840	17.5-15-12	37.1-37.1-36.1	350x300
300-435A1	1342-1677-2012	60-53-46	257-275-295	400x300
300-435A2	1262-1577-1892	52-45-37.5	213-223-230	400x300
300-435A3	1181-1476-1771	42.5-36.5-28.5	171-175-172	400x300
300-435A4	1088-1360-1530	33.8-27.5-24	132-129-128	400x300
300-435B1	1396-1620-1944	57.5-51.5-43.5	240-260-273	400x300
300-435B2	1215-1519-1823	51.5-45-37.5	206-215-222	400x300
300-435B3	1138-1422-1706	43.5-37.5-30	168-173-174	400x300
300-435B4	1066-1332-1598	35-30.5-24.8	130-136-138	400x300
300-560A1	1397-1745-2095	101.5-94-83.5	454-520-570	400x300
300-560A2	1316-1645-1974	83.5-76-67	357-398-433	400x300
300-560A3	1258-1573-1888	68-63-54	281-313-339	400x300
300-560A4	1213-1516-1819	57-50-42	232-247-260	400x300

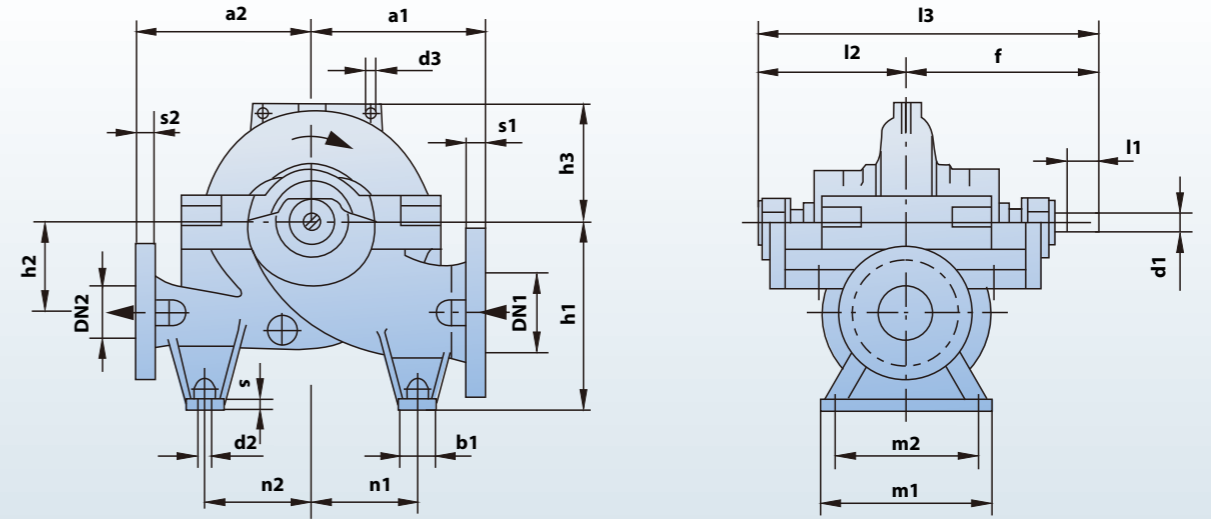
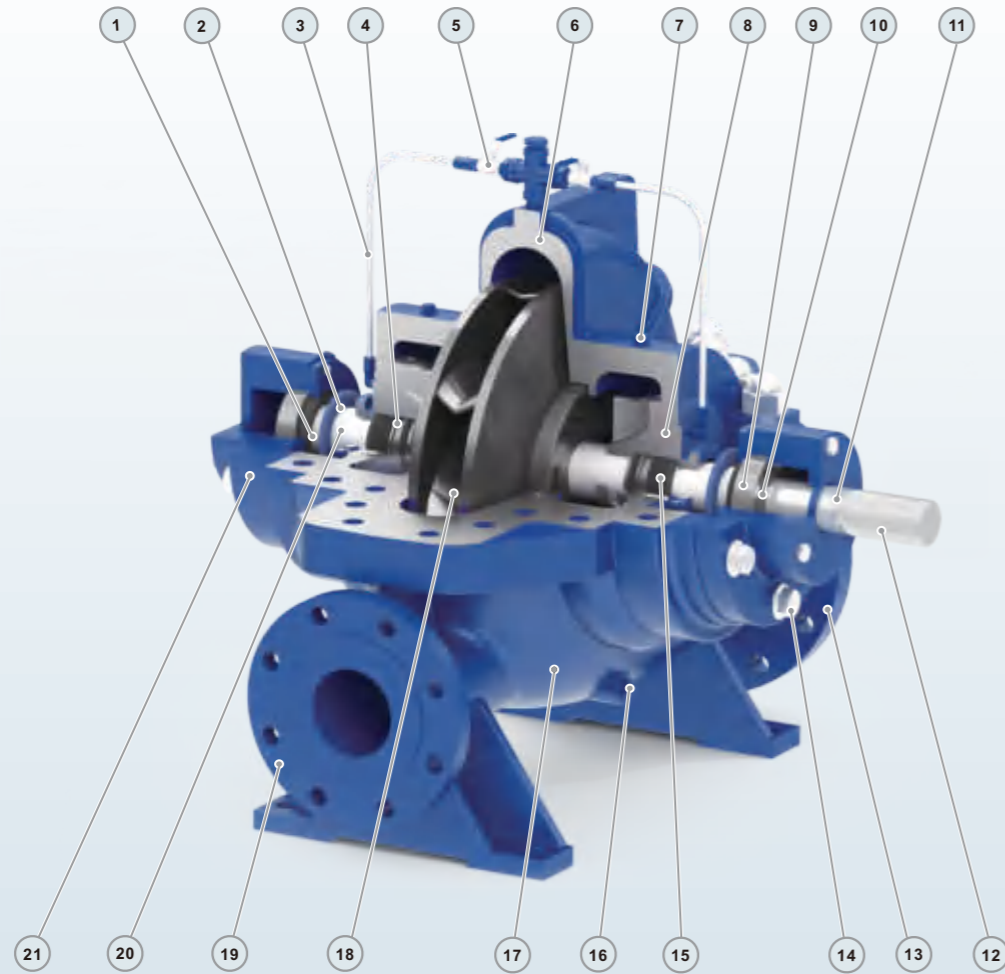

No.	Description Descripción	Material Material	No.	Description Descripción	Material Material	No.	Description Descripción	Material Material
1	Block ring Anillo de bloqueo Bague bloc	Rubber Caucho Caoutchouc	8	Seal house Casa de sello Maison du phoque	Cast iron Fundición Fonte	15	Gland seal(Mechanical Seal) Sello glandular(Cierre Mecánico) Joint étoupe (Joint mécanique)	Synthepak(SiC-Carbon) Synthepak(SiC-Grafito) Synthepak (SiC-Carbon)
2	O-ring Junta tórica Joint torique	Rubber Caucho Caoutchouc	9	Bearing Rodamiento Palier	Ball Bearing Bola Rodamiento Palier Balle	16	Release Valve Tapón Cebado Soupape de décharge	Brass Bronce Laiton
3	Flushing pipe Tubo de enjuague Tuyau de rinçage	SS304 Inox 304 Inox 304	10	Lock washer Arandela de bloquear Rondelle frein	Steel Acero Acier	17	Pump Case Cuerpo de Bomba Boîtier de pompe	Cast iron Fundición Fonte
4	Packing ring Arandela Anneau d'emballage	Carbon Grafito Carbon	11	Shaft Eje Arbre	SS304/45# Steel Inox 304/45# Hierro Inox304-Acier	18	Impeller Impulsor Roue	SS304/Cast iron Inox 304/Fundición Inox 304/Fonte
5	Valve Valva Soupape	Brass Bronce Laiton	12	Shaft Key Chaveta Eje Clé d'arbre	Iron Hierro Le fer	19	Output flange Brida de salida Bride de sortie	Cast iron Fundición Fonte
6	Pump cover Tapa de bomba Couvercle de pompe	Cast iron Fundición Fonte	13	Input flange Brida de entrada Bride d'entrée	Cast iron Fundición Fonte	20	Shaft sleeve Manga de eje Manchon d'arbre	SS304 Inox 304 Inox 304
7	Vent plug Enchufe de ventilación Bouchon d'aération	Brass Bronce Laiton	14	Bolt Perno Boulon	Steel Acero Acier	21	Bearing house Casa de rodamiento Maison de roulement	Cast iron Fundición Fonte

MODEL MODELO MODÈLE	DIMENSIONS/DIMENSIONES/DIMENSIONS mm																				kgs		
	DN1	DN2	s1	s2	a1	a2	d3	f	h1	h2	h3	l2	l3	b1	d2	m1	m2	n1	n2	s		d1	l1
80-210	125	80	34	29	300	300	19	415	315	140	168	300	715	70	17.5	320	270	170	170	20	35	80	185
80-270	125	80	34	29	300	300	19	415	315	140	190	300	715	70	17.5	320	270	170	170	20	35	80	195
80-370	125	80	34	29	330	330	19	415	315	140	225	300	715	70	17.5	320	270	170	170	20	35	80	205
100-250	150	100	37	32	330	330	19	415	355	170	195	300	715	70	17.5	320	270	200	200	20	35	80	210
100-310	150	100	37	32	330	330	19	415	355	170	225	300	715	70	17.5	320	270	200	200	20	35	80	225
100-375	150	100	37	32	370	370	19	415	355	170	260	300	715	70	17.5	320	270	200	200	20	35	80	245
125-230	200	125	41	35	370	370	19	515	400	200	210	366	881	70	17.5	390	340	225	225	20	45	100	250
125-290	200	125	41	35	370	370	19	515	400	200	230	366	881	70	17.5	390	340	225	225	20	45	100	275
125-365	200	125	41	35	370	370	19	515	400	200	260	366	881	70	17.5	390	340	225	225	20	45	100	300
125-500	200	125	41	35	450	450	19	515	400	200	305	366	881	70	17.5	390	340	280	280	20	45	100	335
150-290	200	150	41	37	400	400	19	515	400	200	245	366	881	70	17.5	390	340	225	225	20	45	100	350
150-360	200	150	41	37	400	400	19	515	400	200	265	366	881	70	17.5	390	340	225	225	20	45	100	360
150-460	200	150	41	37	450	450	19	590	400	200	305	399	989	70	17.5	480	430	280	280	20	55	125	440
150-605	200	150	41	37	600	500	19	590	500	300	370	399	989	70	17.5	480	430	350	380	20	55	125	650
200-320	250	200	48	41	450	450	24.5	590	500	240	285	399	989	70	17.5	480	430	280	280	20	55	125	450
200-420	250	200	48	41	500	500	24.5	590	500	240	310	399	989	70	17.5	480	430	280	280	20	55	125	520
200-520	250	200	48	41	600	500	24.5	655	560	300	370	464	1119	70	22	480	400	350	350	26	65	140	840
200-670	250	200	48	41	650	550	24.5	655	600	350	430	464	1119	100	22	480	400	350	350	26	65	140	990
250-370	300	250	33	32	500	500	12.5	655	600	300	320	464	1119	100	22	480	400	350	350	26	65	140	665
250-480	300	250	51	48	550	550	12.5	730	600	300	355	515	1245	100	22	600	520	350	350	26	75	160	830
250-600	300	250	51	48	650	550	12.5	730	630	350	415	515	1245	100	22	600	520	350	350	26	75	160	1215
300-300	350	300	36	33	550	500	24.5	655	630	300	360	464	1119	100	22	480	400	350	350	26	65	140	630
300-435	400	300	38	33	650	550	24.5	730	670	350	365	515	1245	100	22	600	520	350	350	26	75	160	905
300-560	400	300	57	51	700	650	24.5	810	710	350	430	585	1395	100	22	600	520	475	475	26	85	180	1425
300-700	400	300	57	51	750	650	24.5	810	750	400	480	585	1395	100	22	600	520	475	475	26	85	180	1690
350-360	400	350	38	36	650	550	24.5	730	670	350	410	515	1245	100	22	600	520	350	350	26	75	160	865
350-430	450	350	41	36	750	650	24.5	810	750	400	465	585	1395	100	22	600	520	475	475	26	85	180	1285
350-510	400	350	38	36	700	650	24.5	810	750	400	420	585	1395	100	22	600	520	475	475	26	85	180	1395