

50Hz

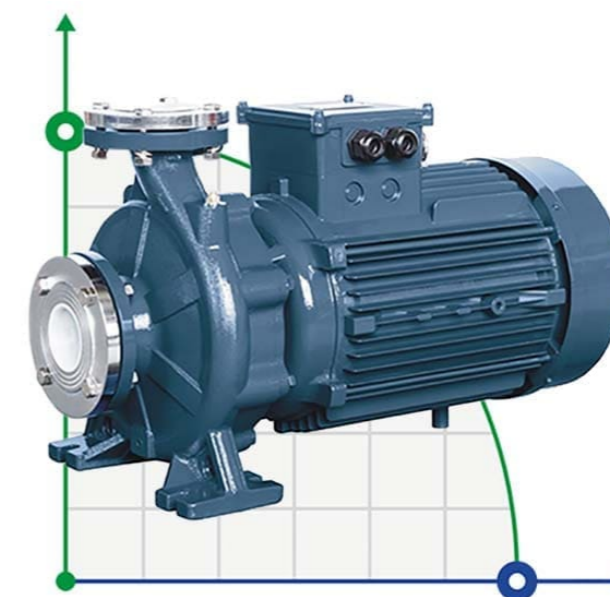

**BST4 Close coupled centrifugal pump**  
**BST4 Bomba centrífuga acoplado cerrado**  
**BST4 Pompe centrifuge à couple fermé**

**BTS**  
ENGINEERING

<https://prom-nasos.pro>  
<https://bts.net.ua>  
<https://prom-nasos.com.ua>

+38 095 656-37-57,  
+38 067 360-71-01,  
+38 063 362-12-31,  
[info@prom-nasos.pro](mailto:info@prom-nasos.pro)

<https://bts.net.ua>



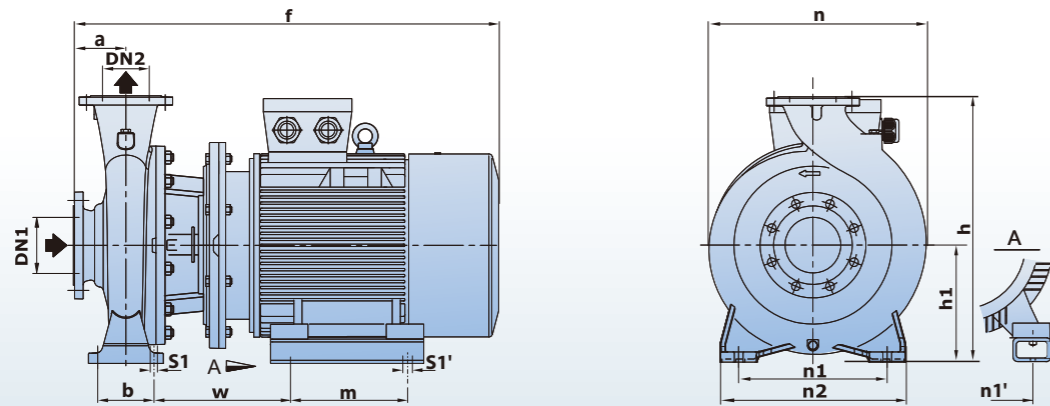

MODEL MODELO MODÈLE	DIMENSIONS/DIMENSIONES/DIMENSIONS mm															kg 3~
	DN1	DN2	a	f	h	h1	n	n1	n1'	n2	b	w	m	s1	s1'	
BST 65-250/220	80	65	116	870	420	180	369	280	279	360	120	237	241	18	15	214
BST 65-250/300	80	65	116	990	420	180	369	280	318	360	120	278	305	18	18	265
BST 65-250/370	80	65	116	990	420	180	369	280	318	360	120	278	305	18	18	285
BST 65-315/450	80	65	125	1069	505	225	440	280	356	360	120	324	311	18	18	371
BST 65-315/550	80	65	125	1160	505	225	440	280	406	360	120	373	349	18	24	450
BST 65-315/750	80	65	125	1232	505	225	440	280	457	360	120	395	368	18	24	582
BST 65-315/900	80	65	125	1283	505	225	440	280	457	360	120	395	419	18	24	617
BST 80-200/220	100	80	125	880	460	250	360	280	279	345	95	251	241	14	15	211
BST 80-200/300	100	80	125	950	460	250	360	280	318	345	95	242	305	14	18	262
BST 80-250/370	100	80	125	950	535	250	410	315	318	400	120	229	305	18	18	289
BST 80-250/450	100	80	125	980	535	250	410	315	356	400	120	235	311	18	18	362
BST 80-250/550	100	80	125	1160	535	250	410	315	406	400	120	373	349	18	24	441
BST 80-315/450	100	80	125	1069	565	250	452	315	356	400	120	324	311	18	18	381
BST 80-315/550	100	80	125	1160	565	250	452	315	406	400	120	373	349	18	24	460
BST 80-315/750	100	80	125	1232	565	250	452	315	457	400	120	395	368	18	24	592
BST 80-315/900	100	80	125	1283	565	250	452	315	457	400	120	395	419	18	24	627
BST 100-200/220	125	100	125	910	530	225	422	280	279	360	120	268	241	18	15	216
BST 100-200/300	125	100	125	1025	530	225	422	280	318	360	120	304	305	18	18	267
BST 100-200/370	125	100	125	1025	530	225	422	280	318	360	120	304	305	18	18	287
BST 100-250/450	125	100	140	1000	580	250	450	315	356	400	120	240	311	18	18	366
BST 100-250/550	125	100	140	1180	580	250	450	315	406	400	120	378	349	18	24	445
BST 100-250/750	125	100	140	1250	580	250	450	315	457	400	120	398	368	18	24	577
BST 100-250/900	125	100	140	1300	580	250	422	315	457	400	120	397	419	18	24	612
BST 100-315/750	125	100	140	1262	625	250	480	315	457	400	120	410	368	19	24	591
BST 100-315/900	125	100	140	1313	625	250	480	315	457	400	120	410	419	19	24	626
BST 100-315/1100	125	100	140	1474	625	250	480	315	508	400	120	436	406	19	28	972
BST 100-315/1320	125	100	140	1584	625	250	480	315	508	400	120	436	457	19	28	1087
BST 100-315/1600	125	100	140	1584	625	250	480	315	508	400	120	436	508	19	28	1125
BST 125-200/450	150	125	140	1099	565	250	422	315	356	400	120	339	311	19	18	378
BST 125-200/550	150	125	140	1190	565	250	422	315	406	400	120	388	349	19	24	457
BST 125-200/750	150	125	140	1262	565	250	422	315	457	400	120	410	368	19	24	589
BST 125-250/550	150	125	140	1190	605	250	500	315	406	400	120	388	349	19	24	457
BST 125-250/750	150	125	140	1262	605	250	500	315	457	400	120	410	368	19	24	589
BST 125-250/900	150	125	140	1313	605	250	500	315	457	400	120	410	419	19	24	624
BST4 65-250/30	80	65	116	606	420	180	369	280	160	360	120	147	140	18	12	71
BST4 65-250/40	80	65	116	594	420	180	369	280	190	360	120	154	140	18	12	87
BST4 65-250/55	80	65	116	638	420	180	369	280	216	360	120	193	140	18	12	98
BST4 65-315/40	80	65	125	644	505	225	440	280	190	360	120	195	140	18	12	101
BST4 65-315/55-75	80	65	125	688	505	225	440	280	216	360	120	234	140	18	12	112/130
BST4 65-315/110-150	80	65	125	858	505	225	440	280	254	360	120	283	210	18	15	163/185
BST4 80-200/30	100	80	125	606	460	250	360	280	160	345	95	151	140	14	12	68
BST4 80-200/40	100	80	125	594	460	250	360	280	190	345	95	158	140	14	12	84

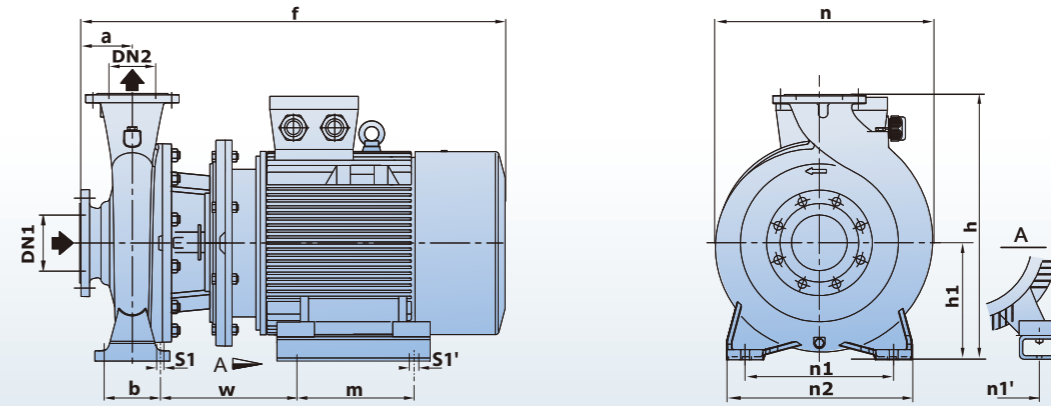

MODEL MODELO MODÈLE	DIMENSIONS/DIMENSIONES/DIMENSIONS mm															kg 3~
	DN1	DN2	a	f	h	h1	n	n1	n1'	n2	b	w	m	s1	s1'	
BST4 80-250/55	100	80	125	638	535	250	410	315	216	400	120	184	140	18	12	102
BST4 80-250/75	100	80	125	638	535	250	410	315	216	400	120	184	140	18	12	120
BST4 80-250/110	100	80	125	808	535	250	410	315	254	400	120	233	210	18	15	154
BST4 80-315/55-75	100	80	125	688	565	250	452	315	216	400	120	234	140	18	12	122/140
BST4 80-315/110-150	100	80	125	858	565	250	452	315	254	400	120	283	210	18	15	173/195
BST4 80-400/185	100	80	125	902	635	280	536	315	254	400	120	283	254	18	15	251
BST4 80-400/220	100	80	125	938	635	280	536	315	279	400	120	296	241	18	15	271
BST4 80-400/300	100	80	125	1029	635	280	536	315	318	400	120	308	305	18	18	334
BST4 100-200/40	125	100	125	644	530	225	422	280	190	360	120	195	140	18	12	89
BST4 100-200/55-75	125	100	125	688	530	225	422	280	216	360	120	234	140	18	12	100/118
BST4 100-250/55-75	125	100	140	688	580	250	450	315	216	400	120	219	140	18	12	107/125
BST4 100-250/110-150	125	100	140	858	580	250	450	315	254	400	120	268	210	18	15	158/180
BST4 100-315/150	125	100	140	888	625	250	480	315	254	400	120	298	210	19	15	194
BST4 100-315/185	125	100	140	932	625	250	480	315	254	400	120	298	254	19	15	234
BST4 100-315/220	125	100	140	968	625	250	480	315	279	400	120	311	241	19	15	254
BST4 100-315/300	125	100	140	1059	625	250	480	315	318	400	120	323	305	19	18	317
BST4 100-400/300-370	125	100	140	1059	655	280	548	400	318	500	150	308	305	23	18	348/391
BST4 100-400/450	125	100	140	1099	655	280	548	400	356	500	150	324	311	23	18	418
BST4 125-200/55-75	150	125	140	718	565	250	422	315	216	400	120	249	140	19	12	107/125
BST4 125-200/110	150	125	140	888	565	250	422	315	254	400	120	298	210	19	15	170
BST4 125-250/75	150	125	140	718	605	250	500	315	216	400	120	249	140	19	12	137
BST4 125-250/110-150	150	125	140	888	605	250	500	315	254	400	120	298	210	19	15	170/192
BST4 125-250/185	150	125	140	932	605	250	500	315	254	400	120	298	254	19	15	232
BST4 125-315/185	150	125	140	932	635	280	525	400	254	500	150	283	254	23	15	252
BST4 125-315/220	150	125	140	968	635	280	525	400	279	500	150	296	241	23	15	272
BST4 125-315/300-370	150	125	140	1059	635	280	525	400	318	500	150	308	305	23	18	335/378
BST4 150-200/110-150	200	150	160	928	680	280	435	450	254	550	150	303	210	23	15	197/219
BST4 150-200/185	200	150	160	972	680	280	435	450	254	550	150	303	254	23	15	259
BST4 150-200/220	200	150	160	1008	680	280	435	450	279	550	150	316	241	23	15	279
BST4 150-250/150	200	150	160	928	715	280	510	450	254	550	150	303	210	23	15	226
BST4 150-250/185	200	150	160	972	715	280	510	450	254	550	150	303	254	23	15	266
BST4 150-250/220	200	150	160	1008	715	280	510	450	279	550	150	316	241	23	15	286
BST4 150-250/300	200	150	160	1099	715	280	510	450	318	550	150	328	305	23	18	349
BST4 150-315/370	200	150	160	1099	740	280	548	450	318	550	150	328	305	23	18	395
BST4 150-315/450	200	150	160	1139	740	280	548	450	356	550	150	344	311	23	18	422
BST4 150-315/550	200	150	160	1230	740	280	548	450	406	550	150					

**65-250**

1450rpm

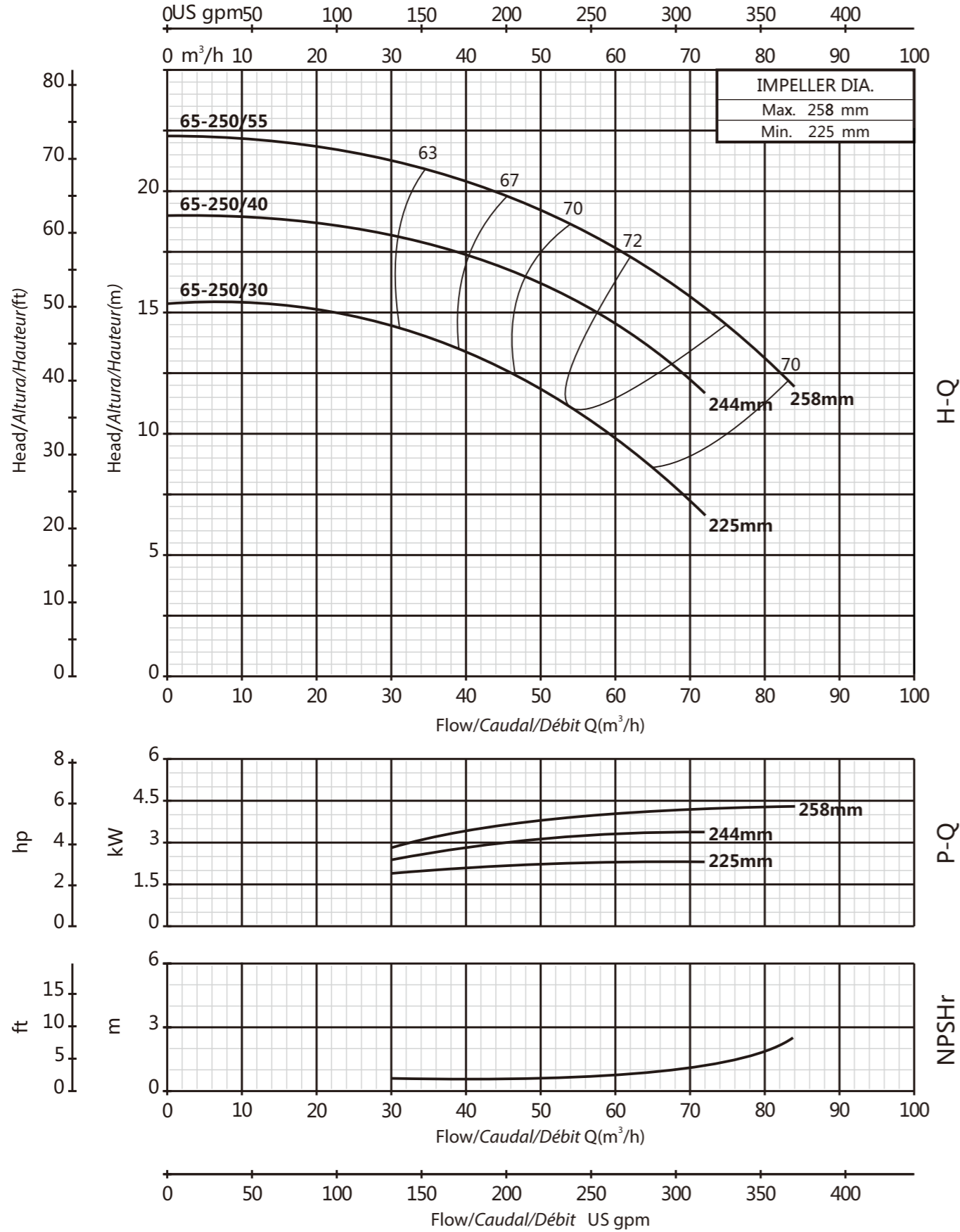

**65-315**

1450rpm

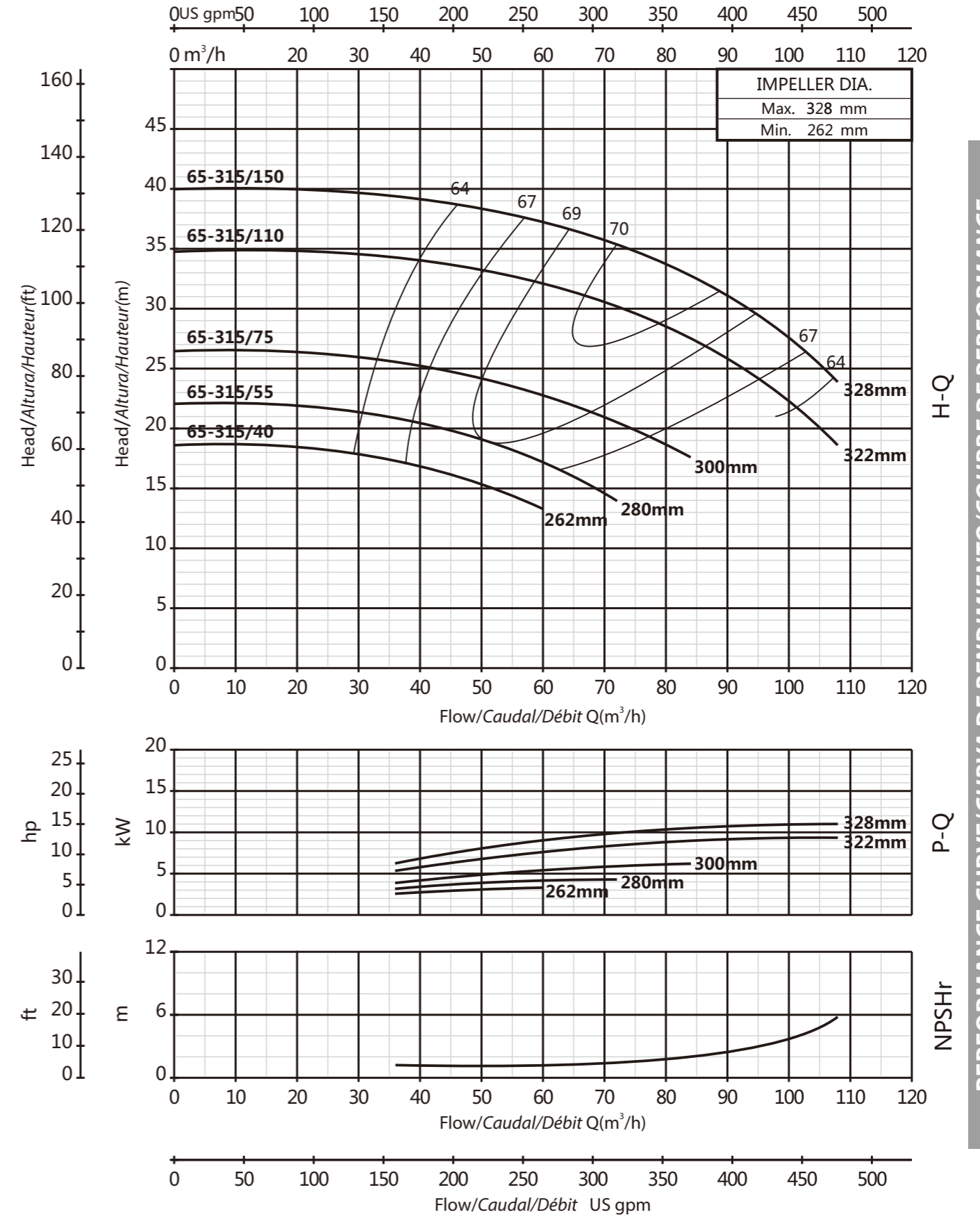

PERFORMANCE CURVE/CURVA DE RENDIMIENTO/COURBE DE PERFORMANCE

PERFORMANCE CURVE/CURVA DE RENDIMIENTO/COURBE DE PERFORMANCE

**80-160**

1450rpm

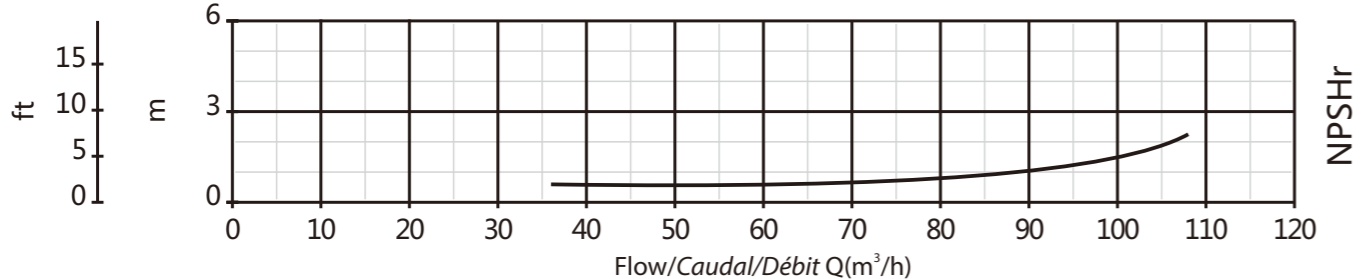
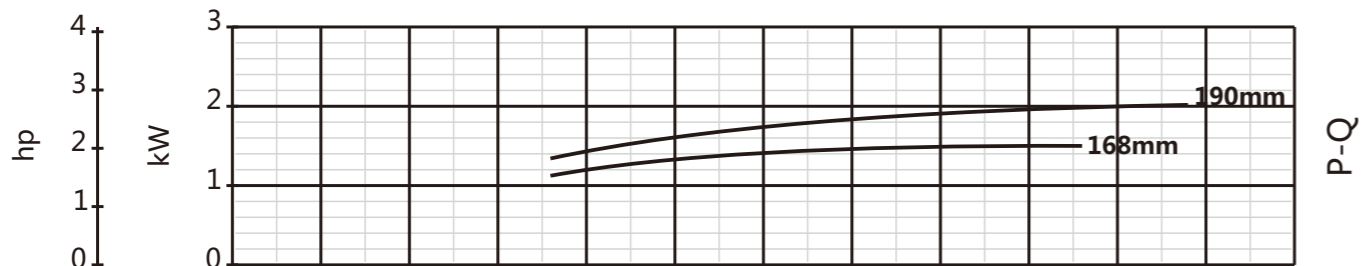
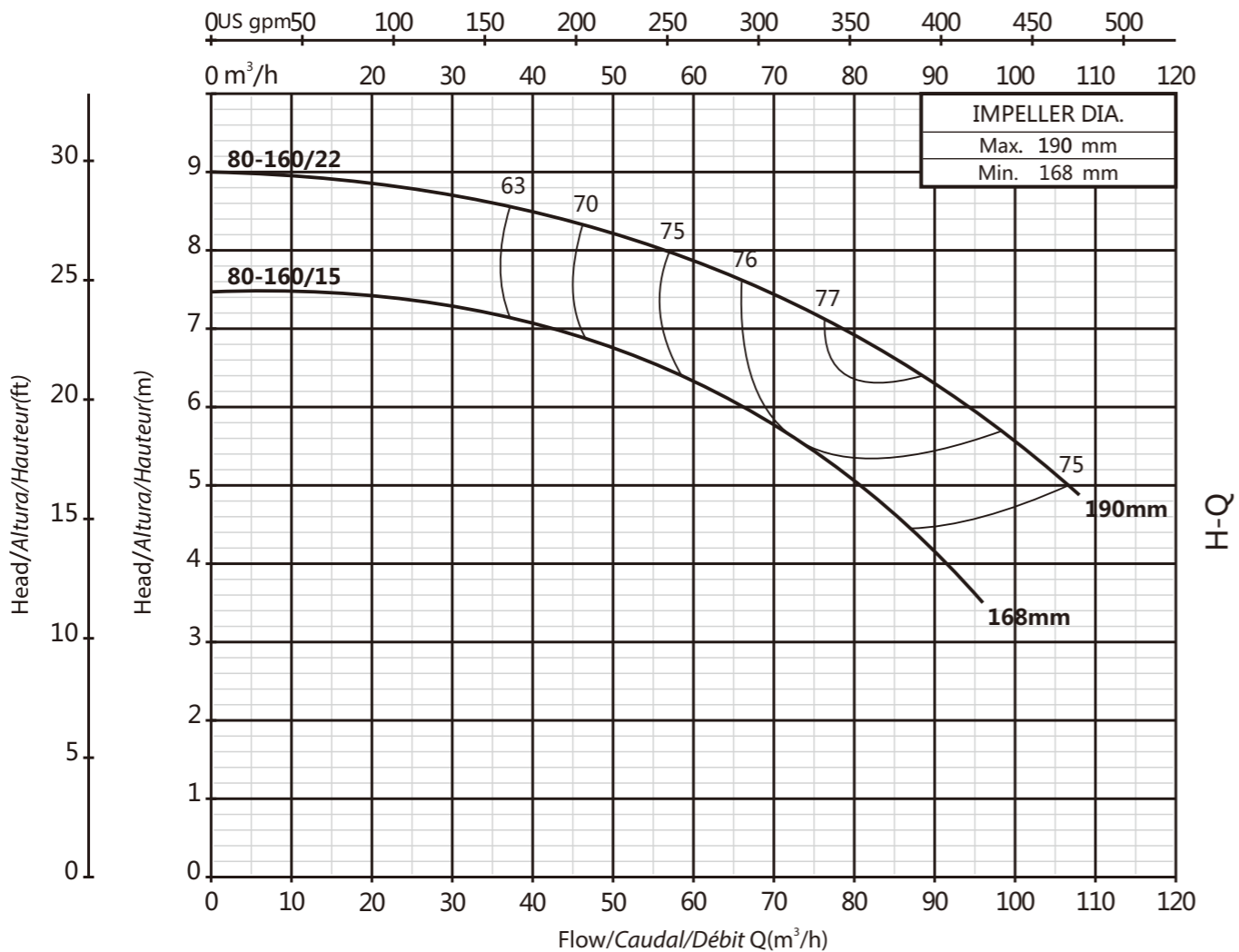

Flow/Caudal/Débit US gpm

**80-200**

1450rpm

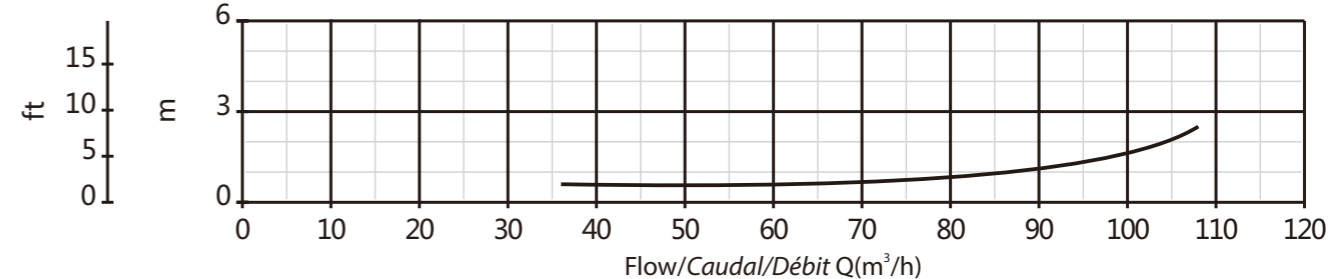
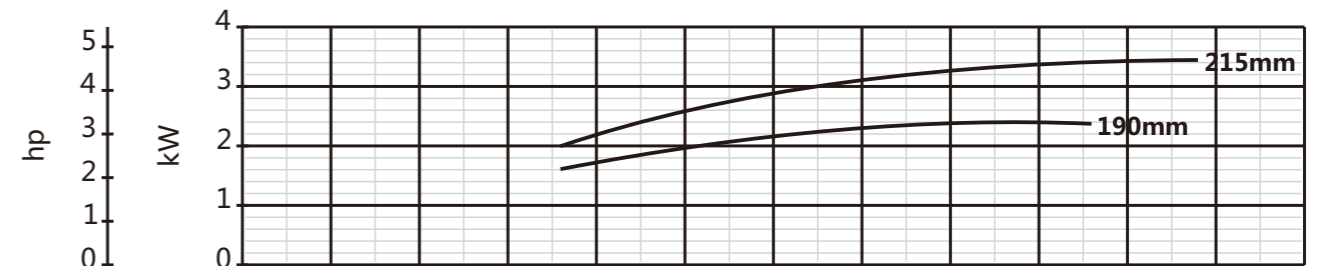
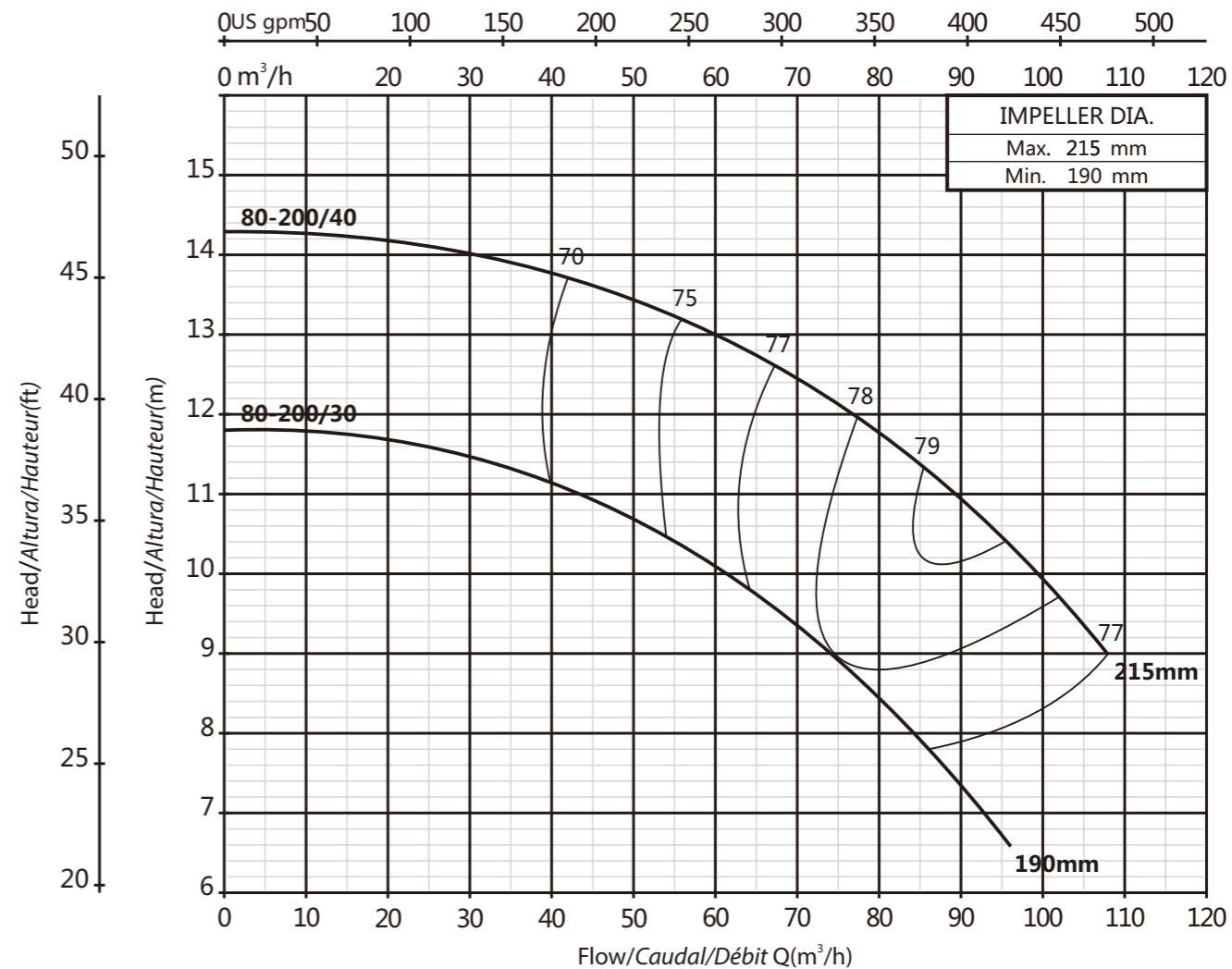

Flow/Caudal/Débit US gpm

PERFORMANCE CURVE/CURVA DE RENDIMIENTO/COURBE DE PERFORMANCE

PERFORMANCE CURVE/CURVA DE RENDIMIENTO/COURBE DE PERFORMANCE

### 80-250

1450rpm

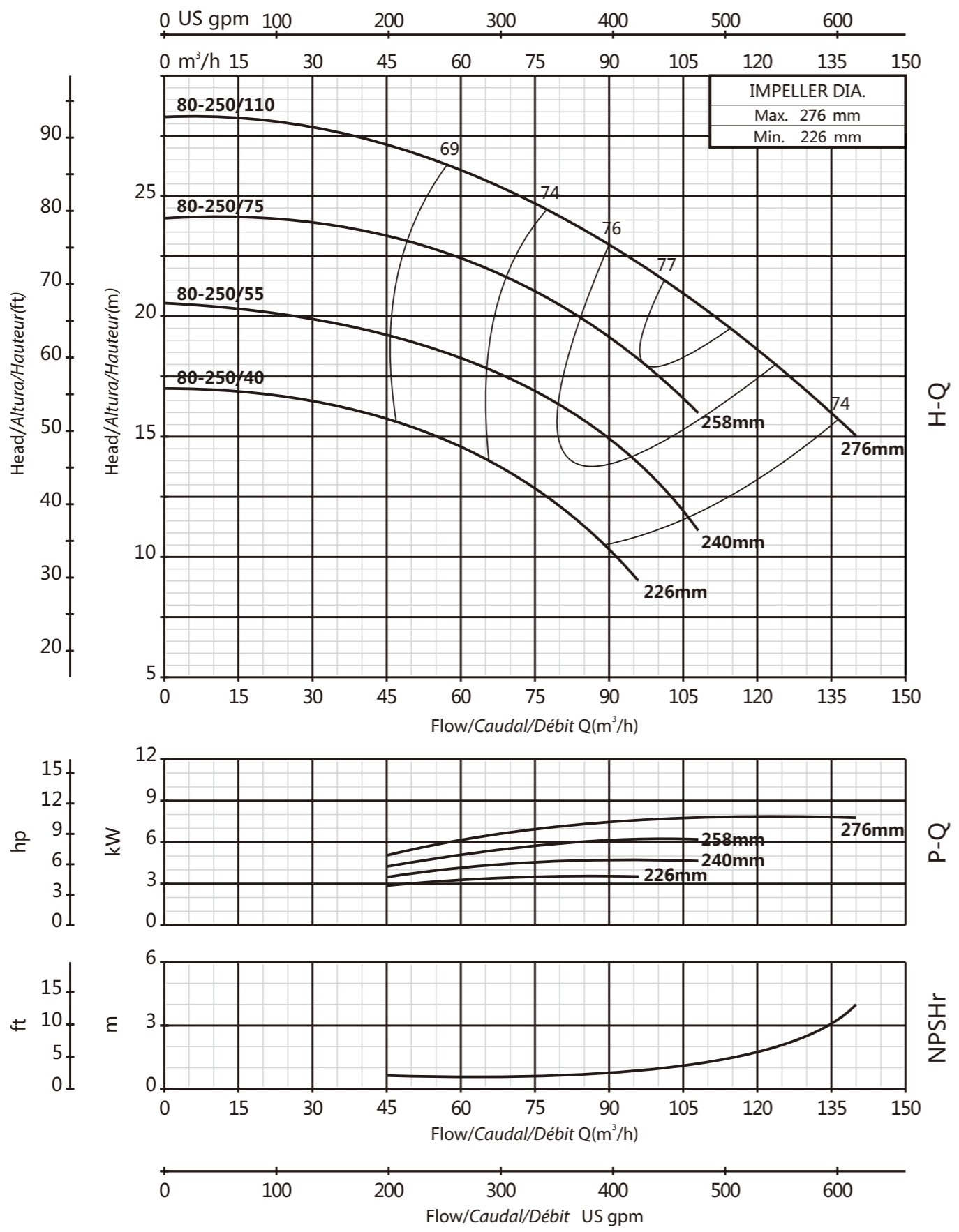

### 80-315

1450rpm

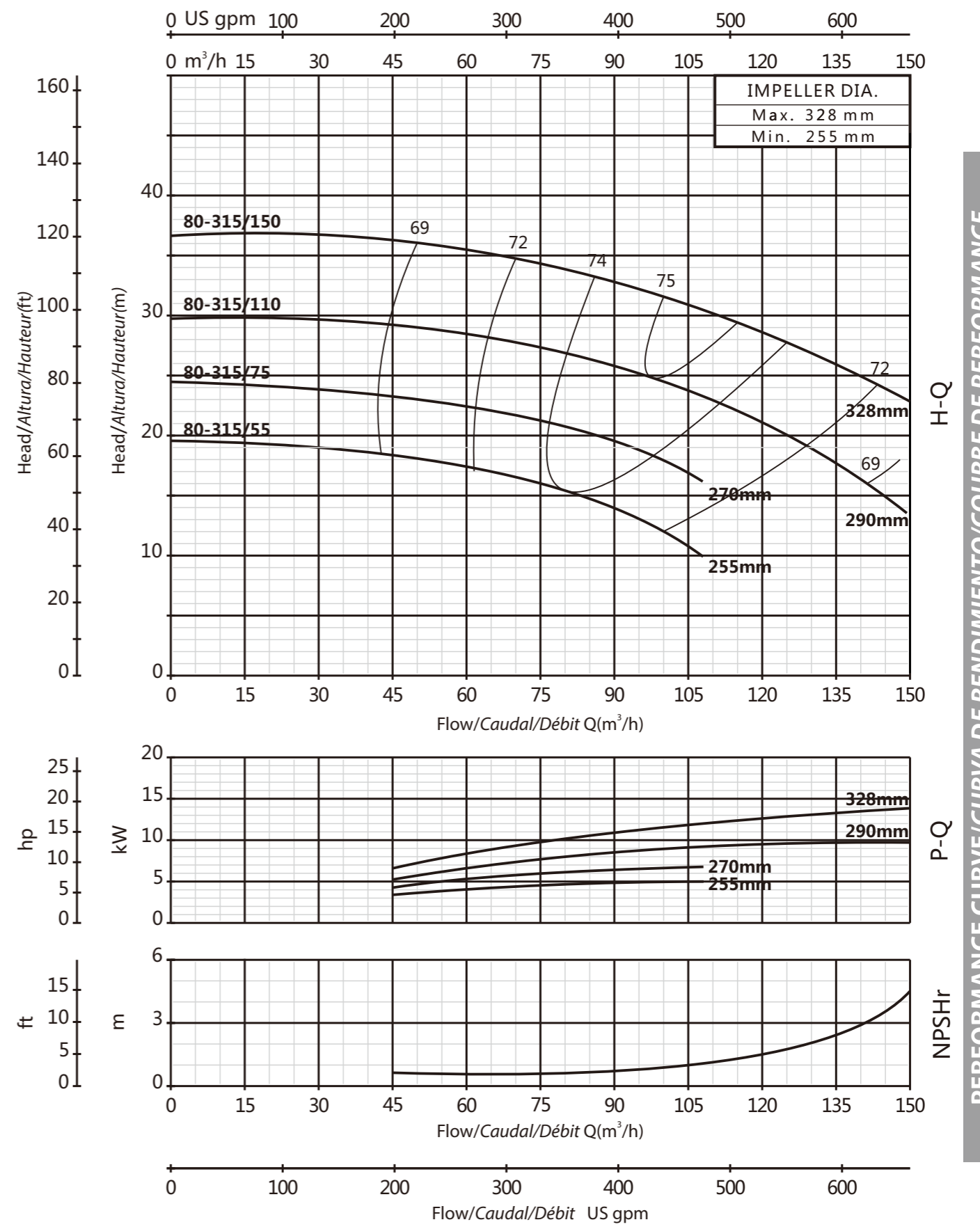

PERFORMANCE CURVE/CURVA DE RENDIMIENTO/COURBE DE PERFORMANCE

PERFORMANCE CURVE/CURVA DE RENDIMIENTO/COURBE DE PERFORMANCE

**80-400**

1450rpm

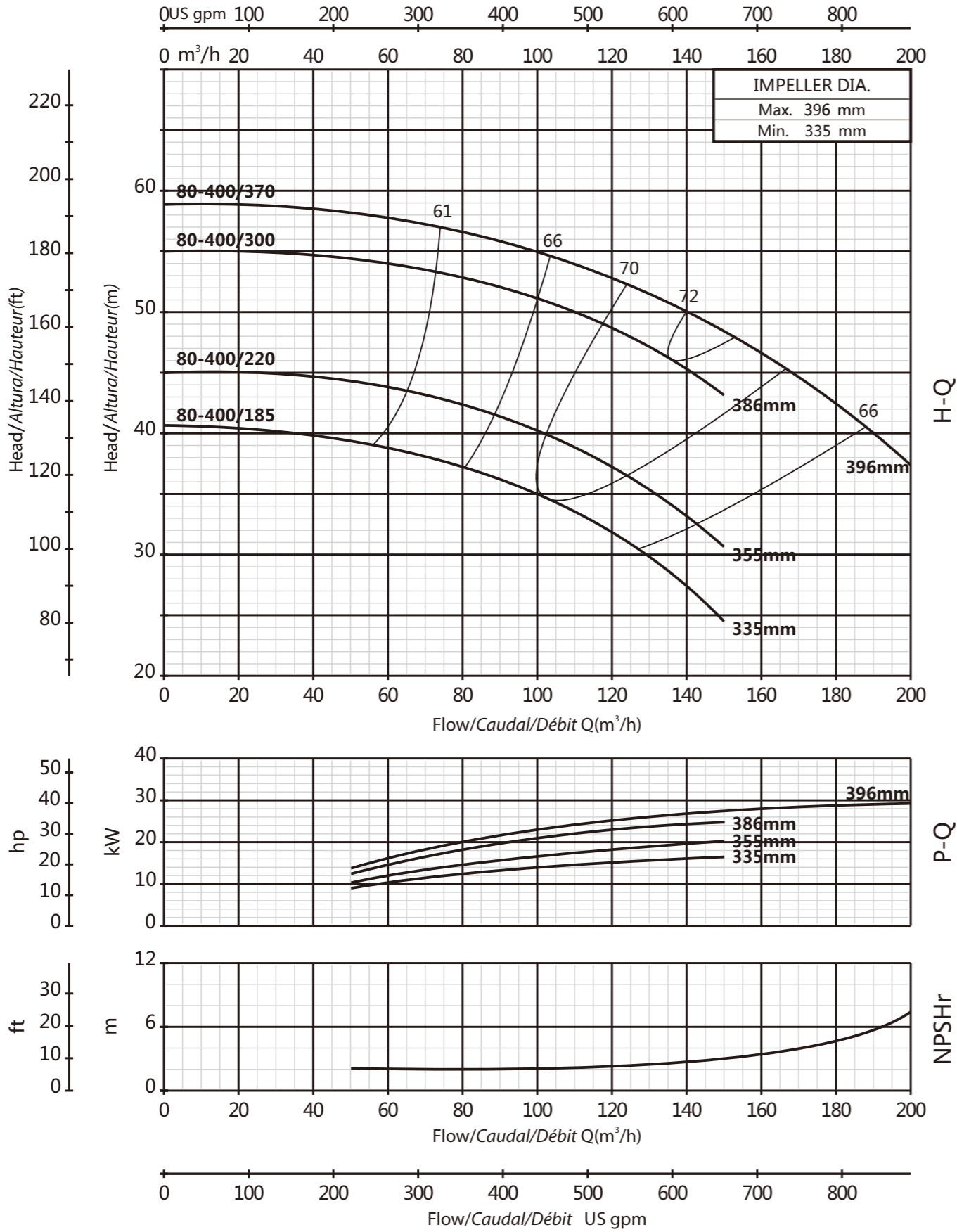

**100-160**

1450rpm

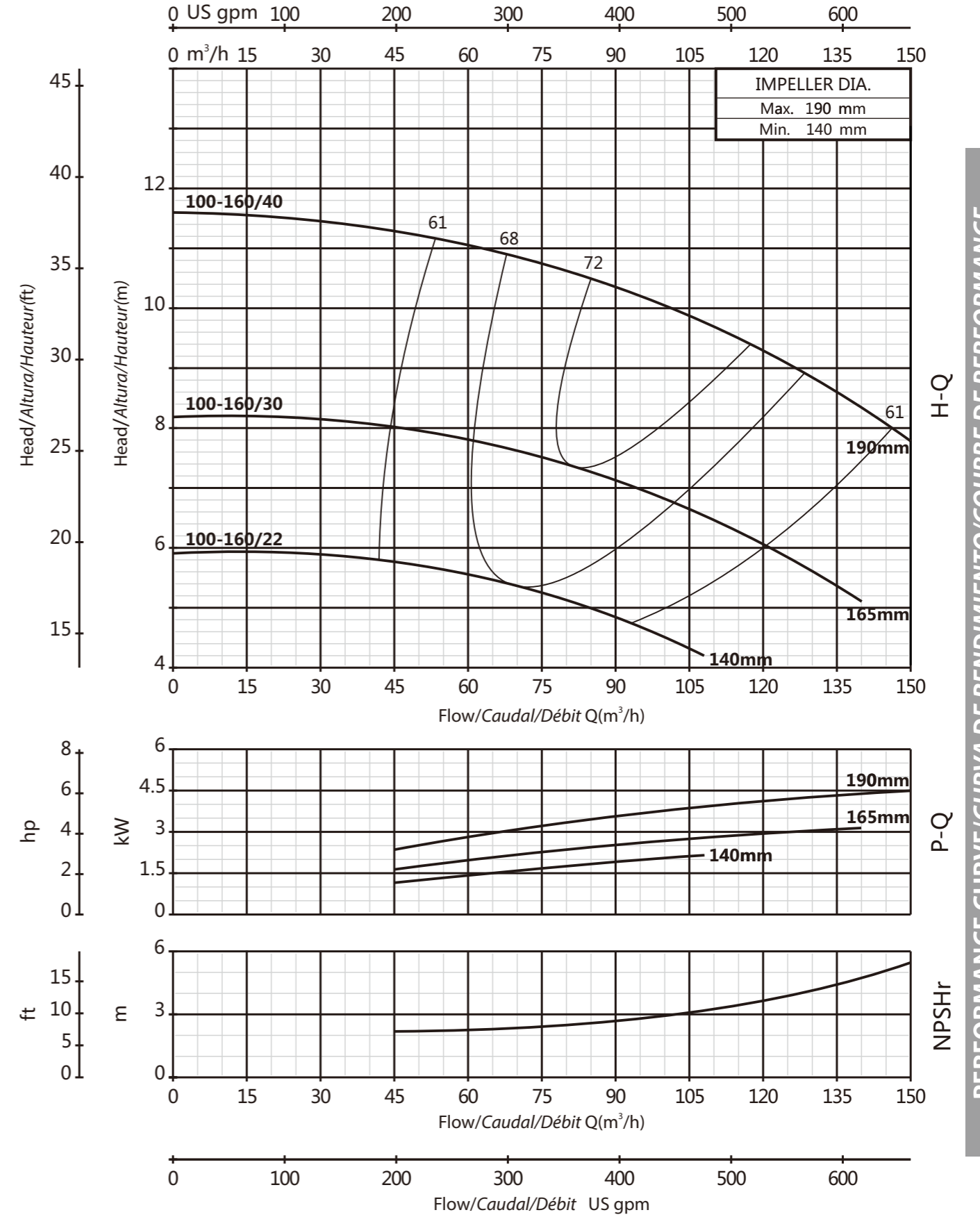

PERFORMANCE CURVE/CURVA DE RENDIMIENTO/COURBE DE PERFORMANCE

PERFORMANCE CURVE/CURVA DE RENDIMIENTO/COURBE DE PERFORMANCE

### 100-200

1450rpm

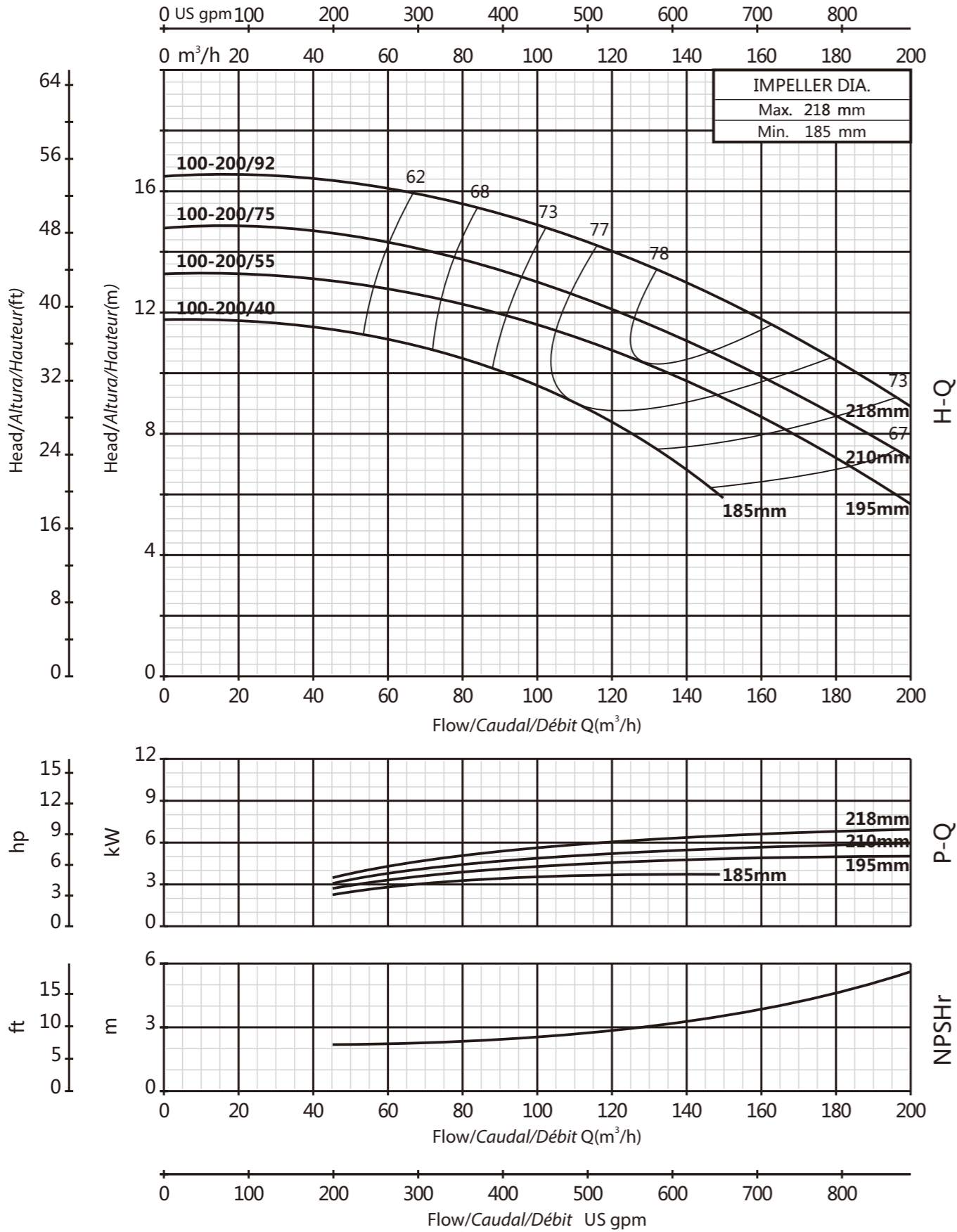

### 100-250

1450rpm

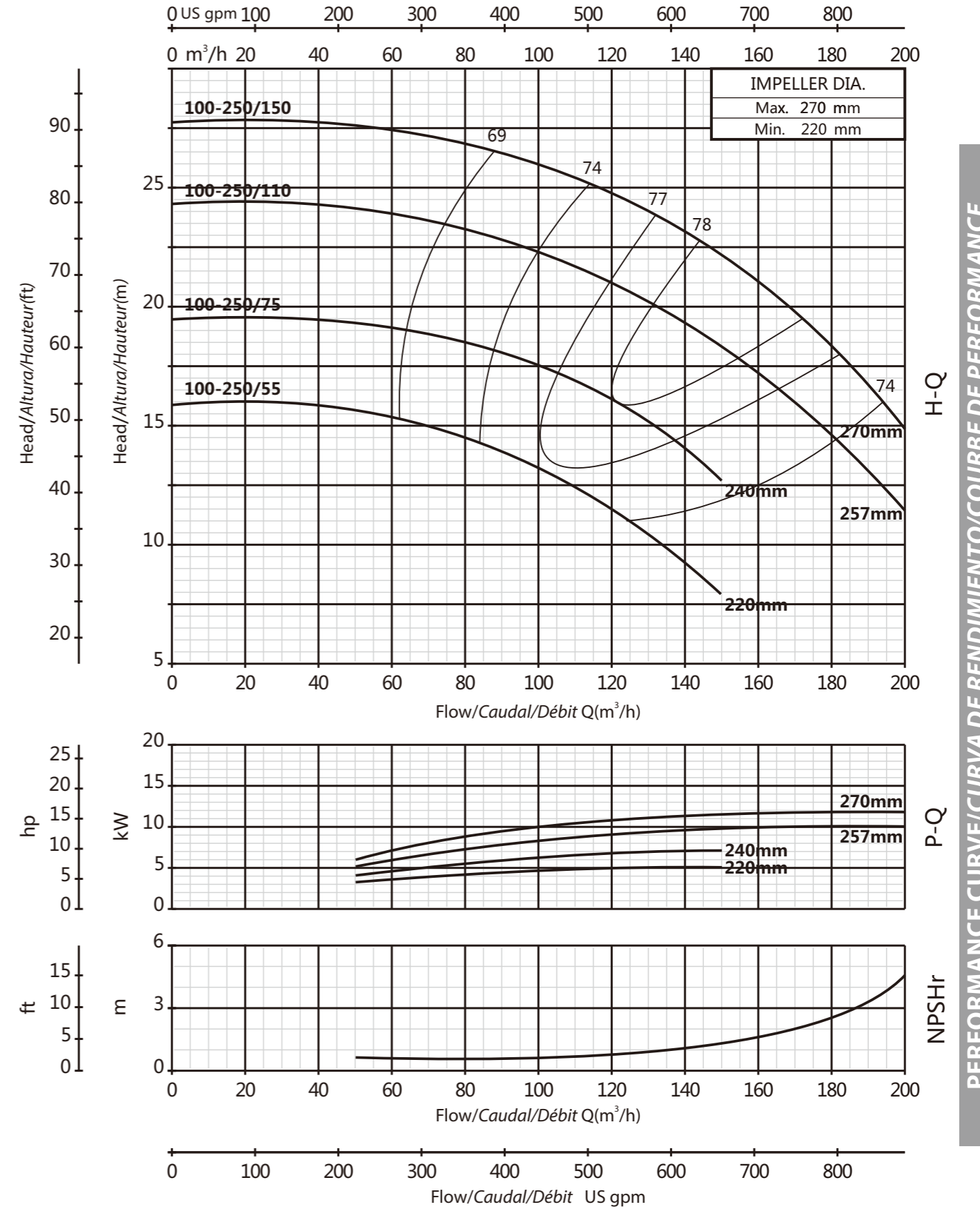

PERFORMANCE CURVE/CURVA DE RENDIMIENTO/COURBE DE PERFORMANCE

PERFORMANCE CURVE/CURVA DE RENDIMIENTO/COURBE DE PERFORMANCE



### 100-315

1450rpm

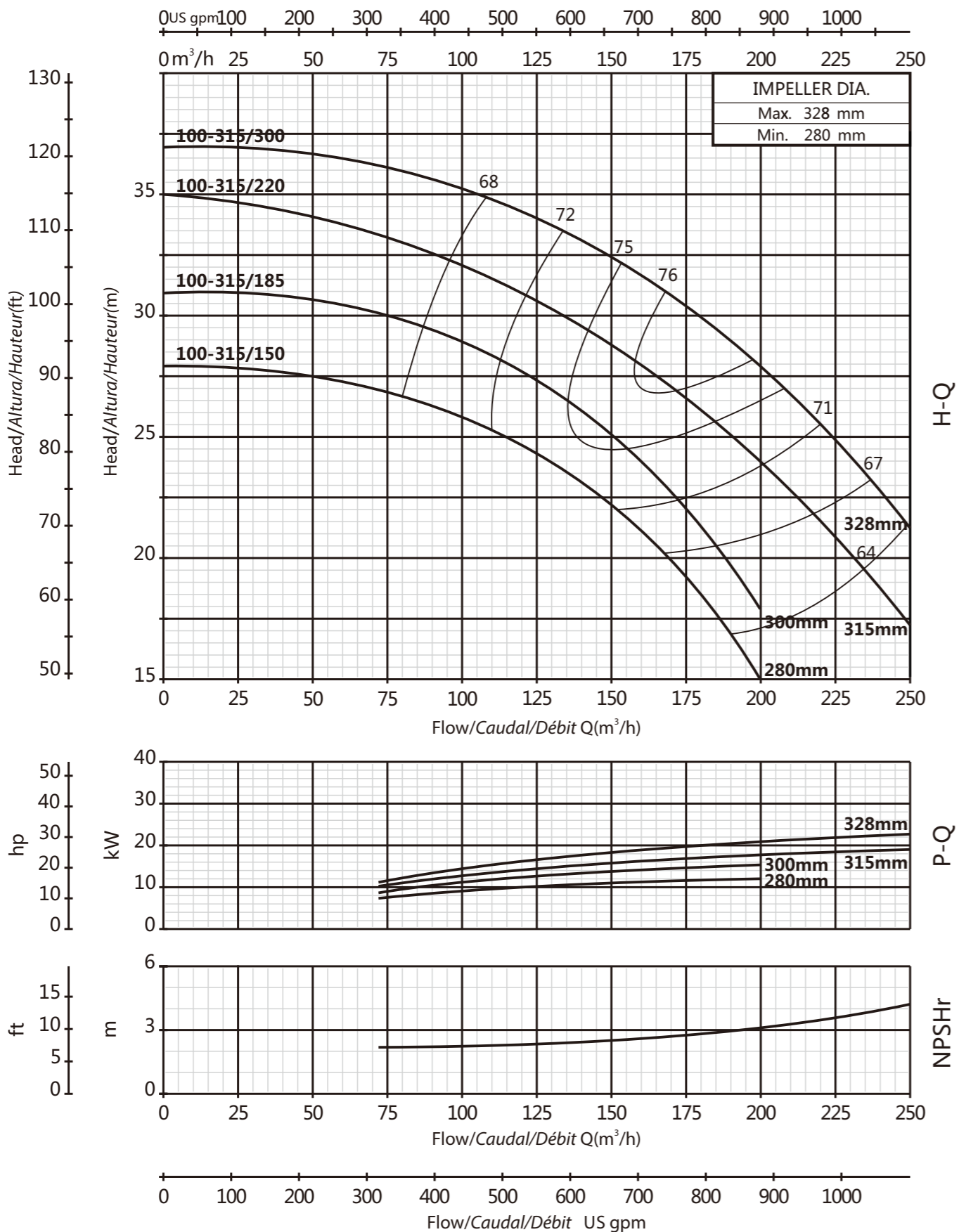

### 100-400

1450rpm

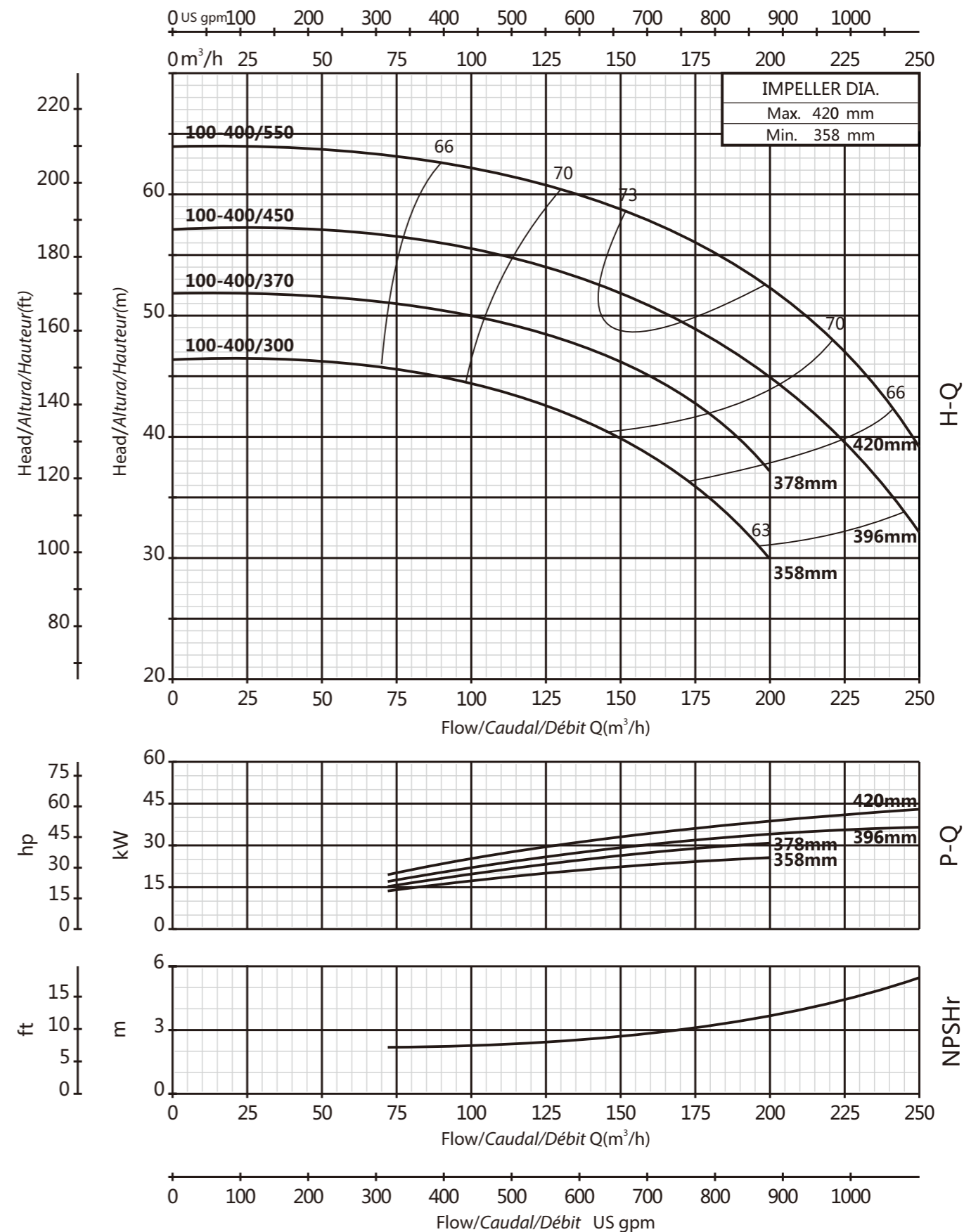

PERFORMANCE CURVE/CURVA DE RENDIMIENTO/COURBE DE PERFORMANCE

PERFORMANCE CURVE/CURVA DE RENDIMIENTO/COURBE DE PERFORMANCE

### 125-200

1450rpm

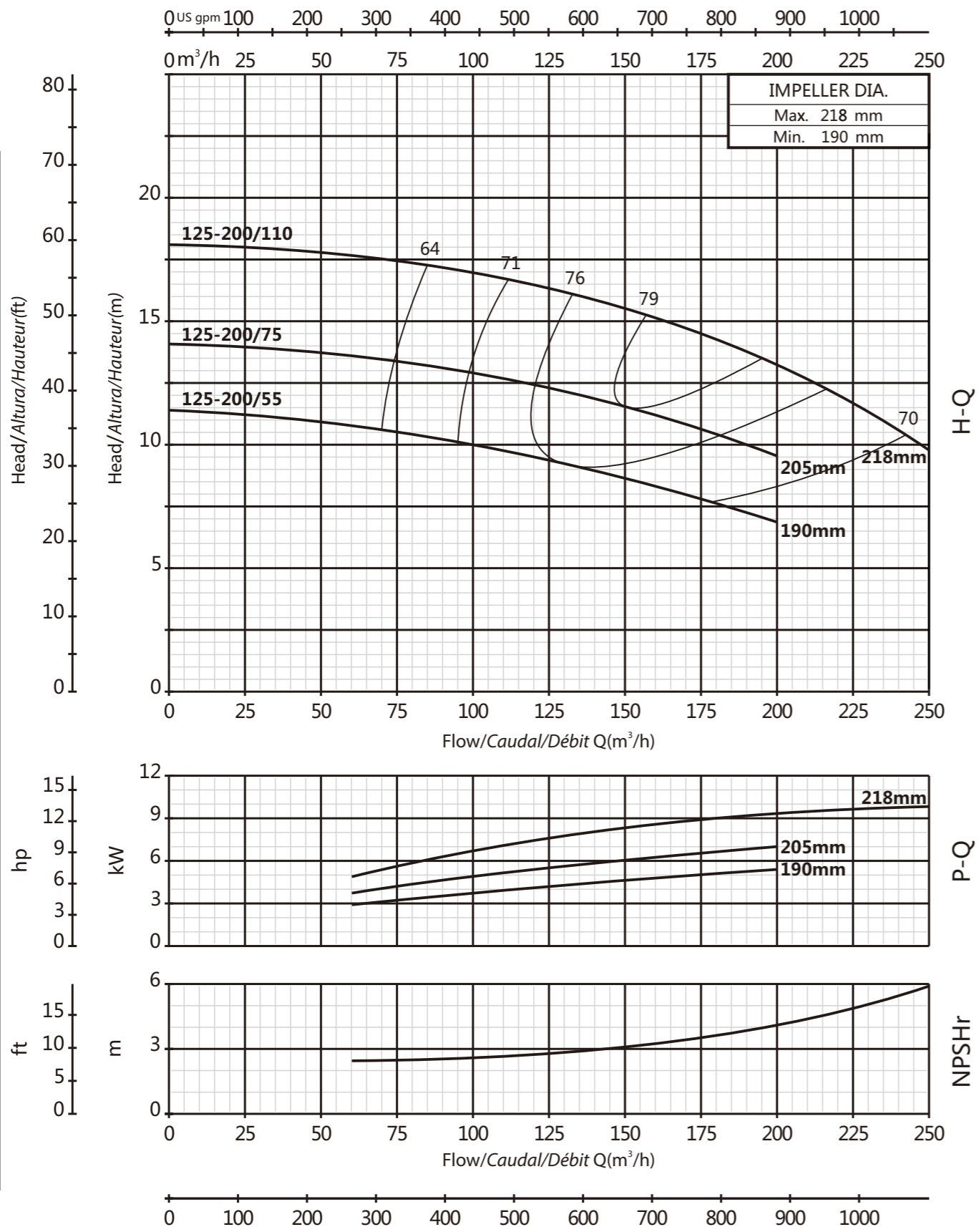

### 125-250

1450rpm

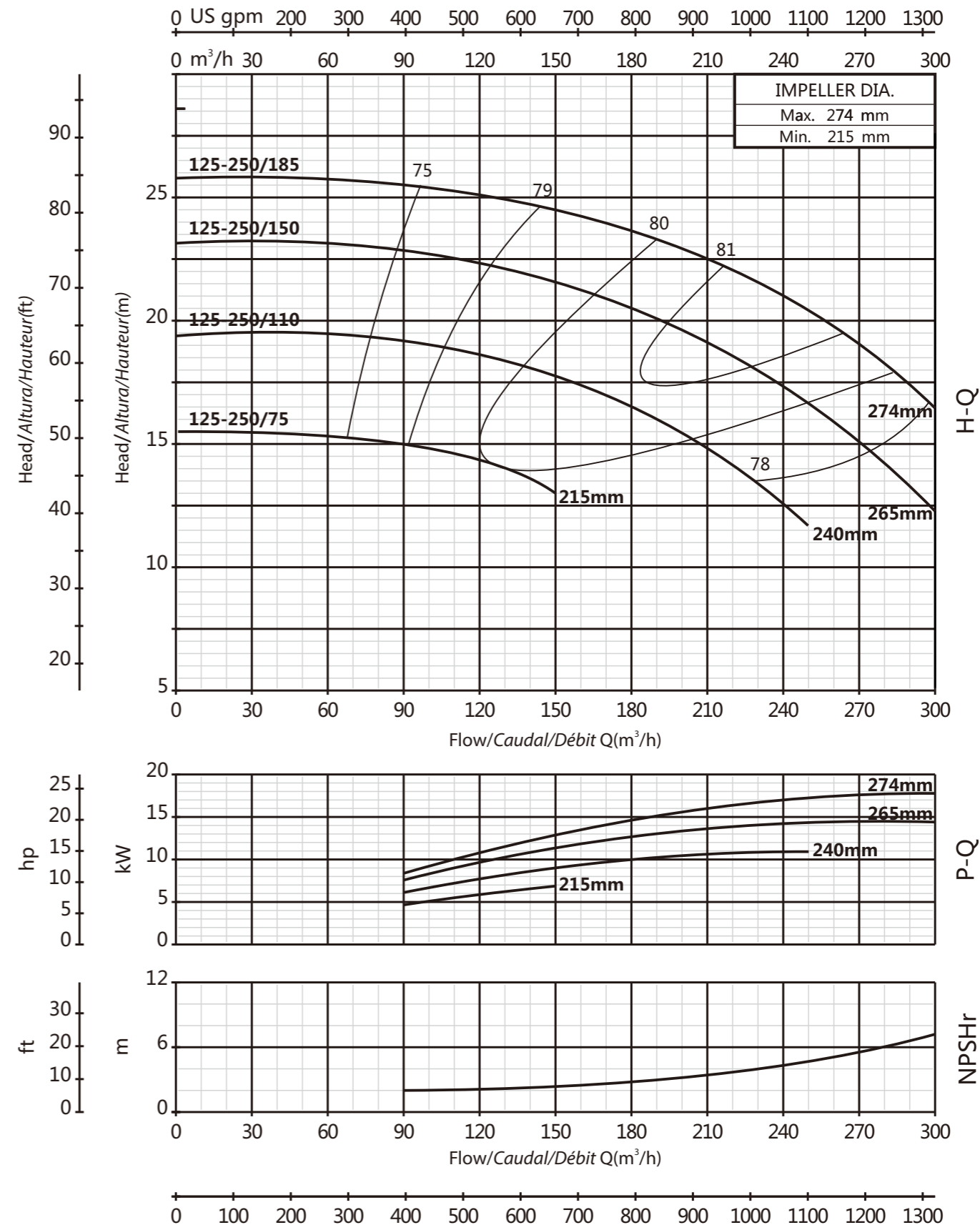

PERFORMANCE CURVE/CURVA DE RENDIMIENTO/COURBE DE PERFORMANCE

PERFORMANCE CURVE/CURVA DE RENDIMIENTO/COURBE DE PERFORMANCE

### 125-315

1450rpm

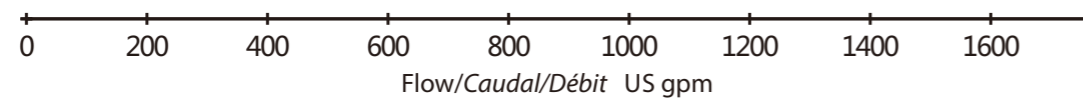
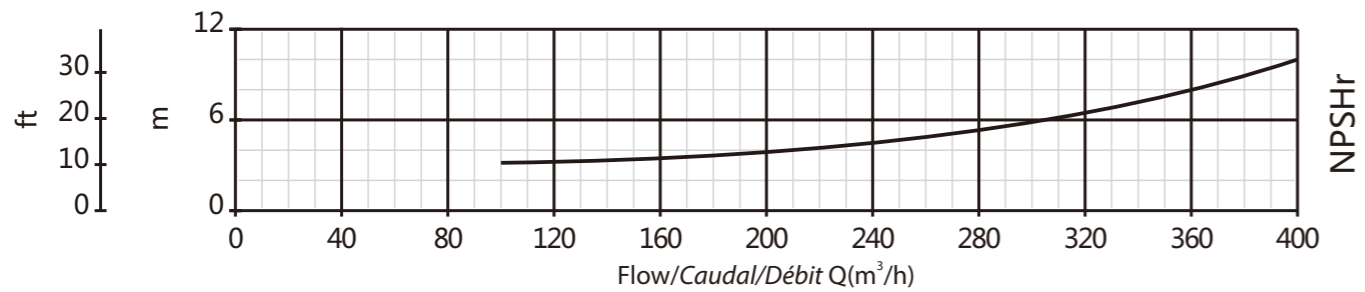
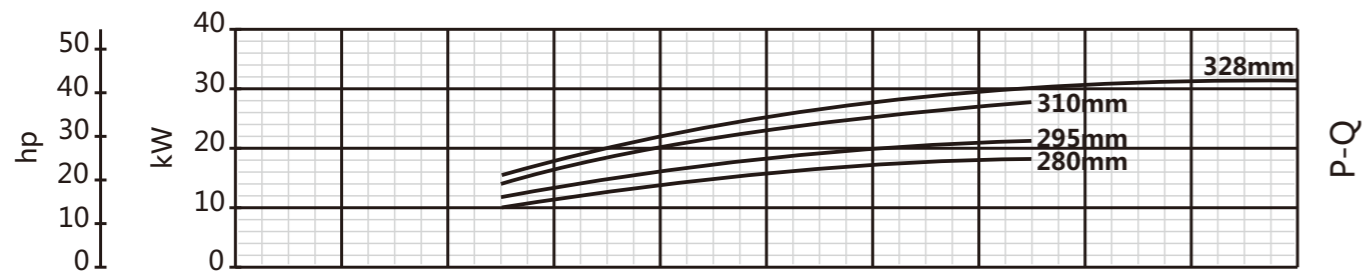
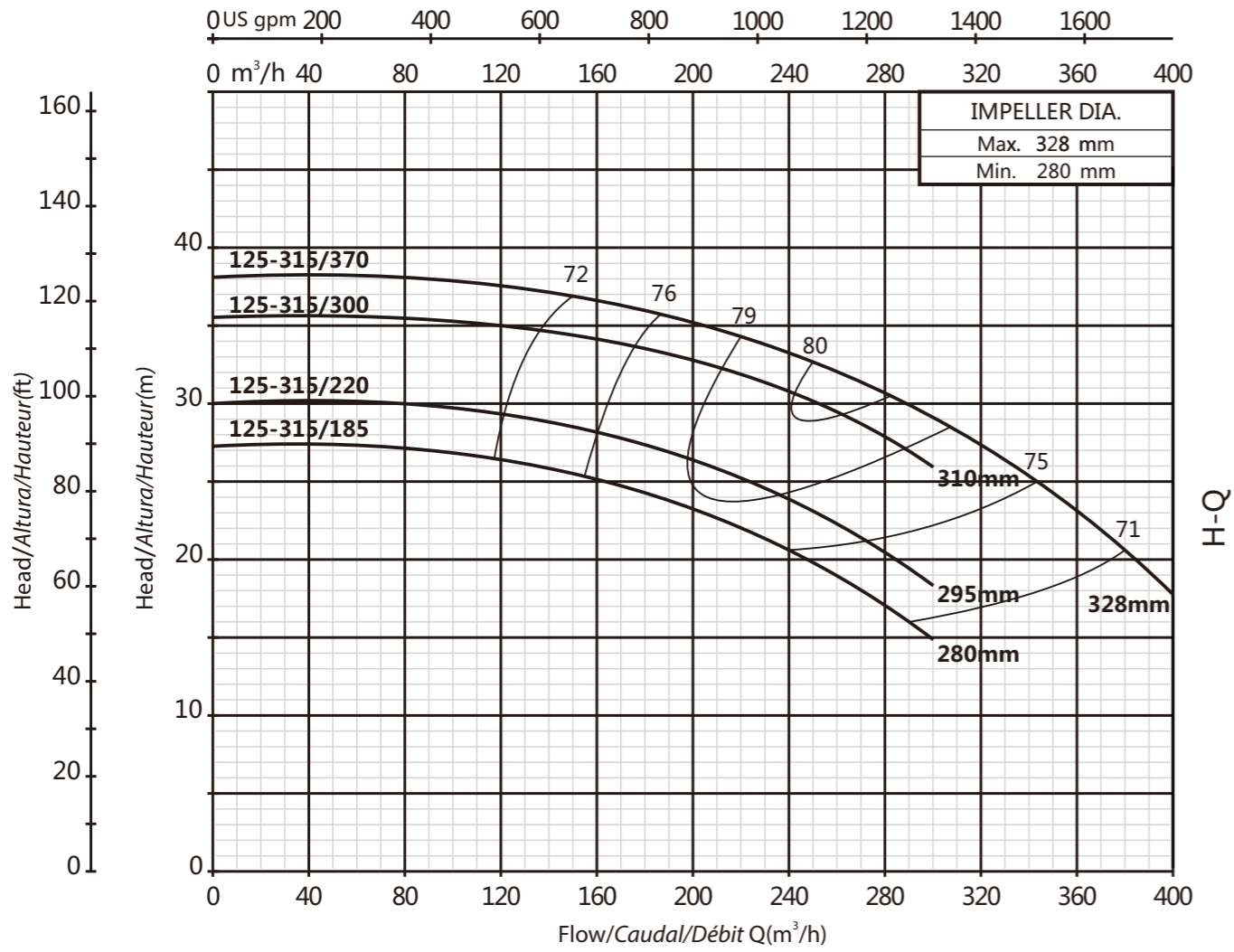

### 125-400

1450rpm

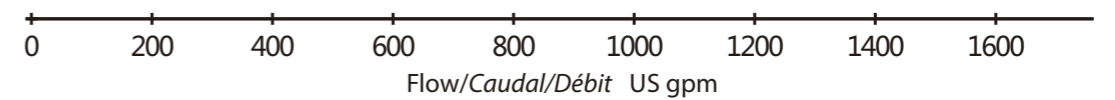
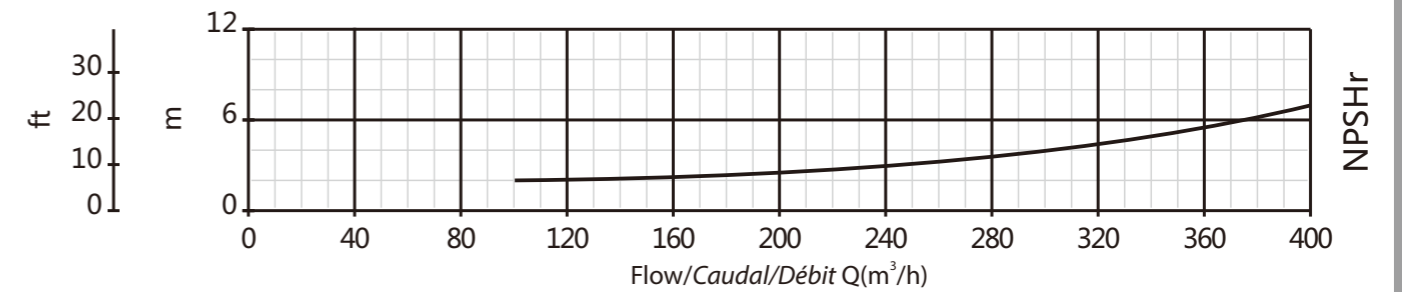
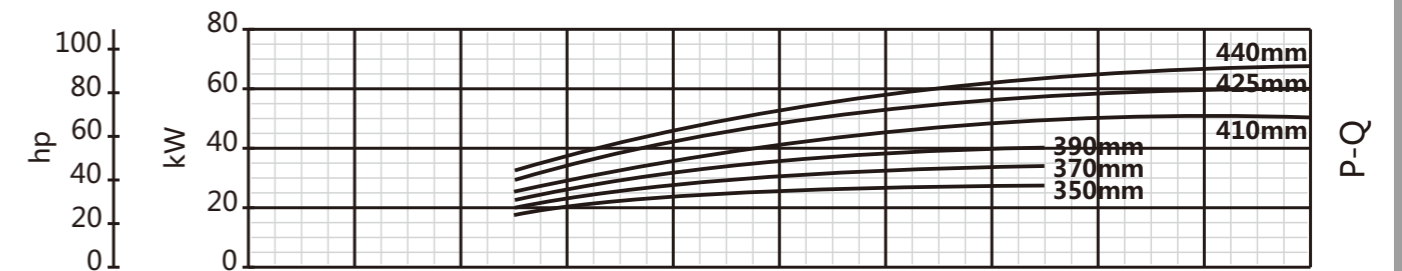
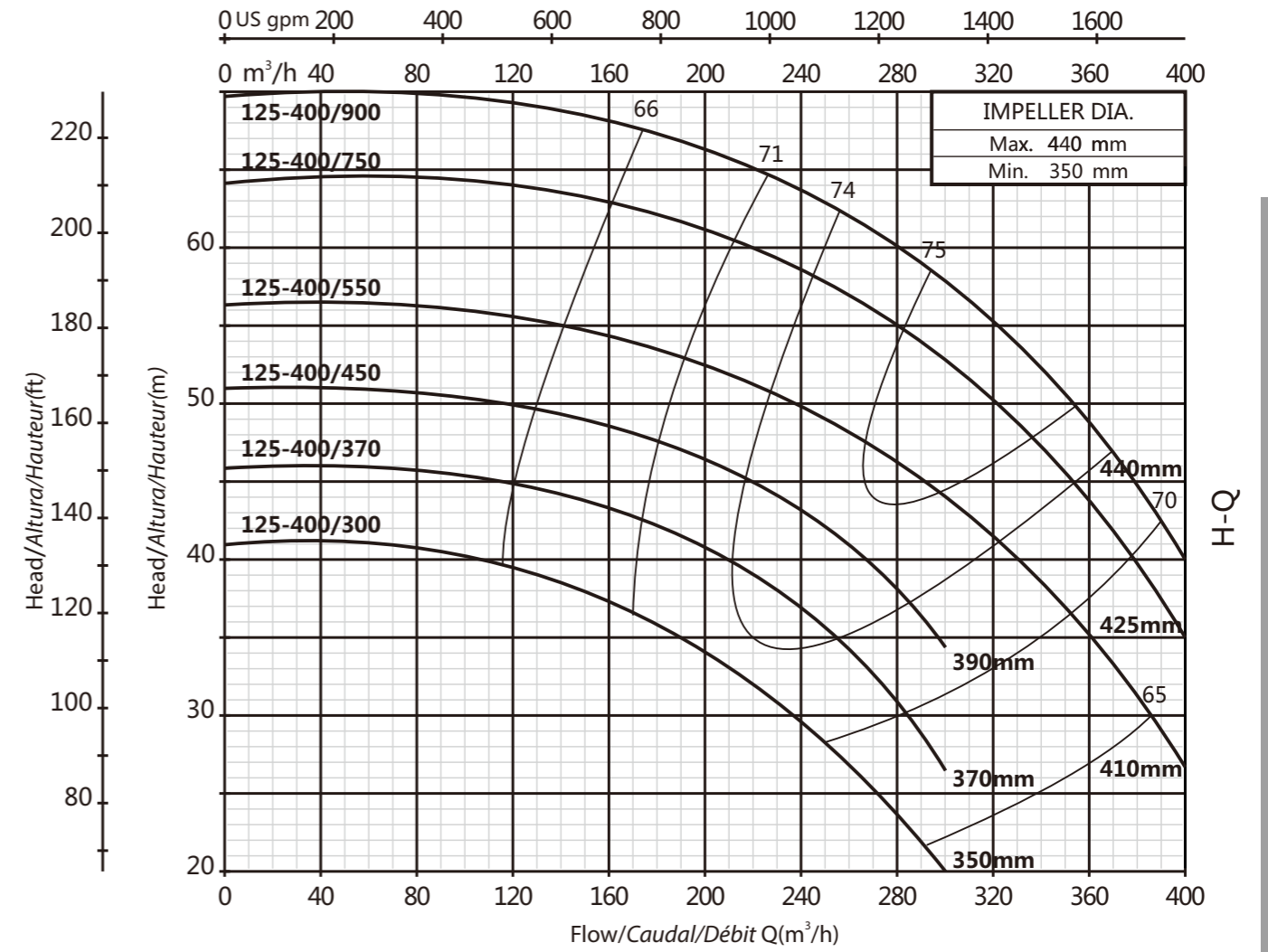

PERFORMANCE CURVE/CURVA DE RENDIMIENTO/COURBE DE PERFORMANCE

PERFORMANCE CURVE/CURVA DE RENDIMIENTO/COURBE DE PERFORMANCE

### 150-200

1450rpm

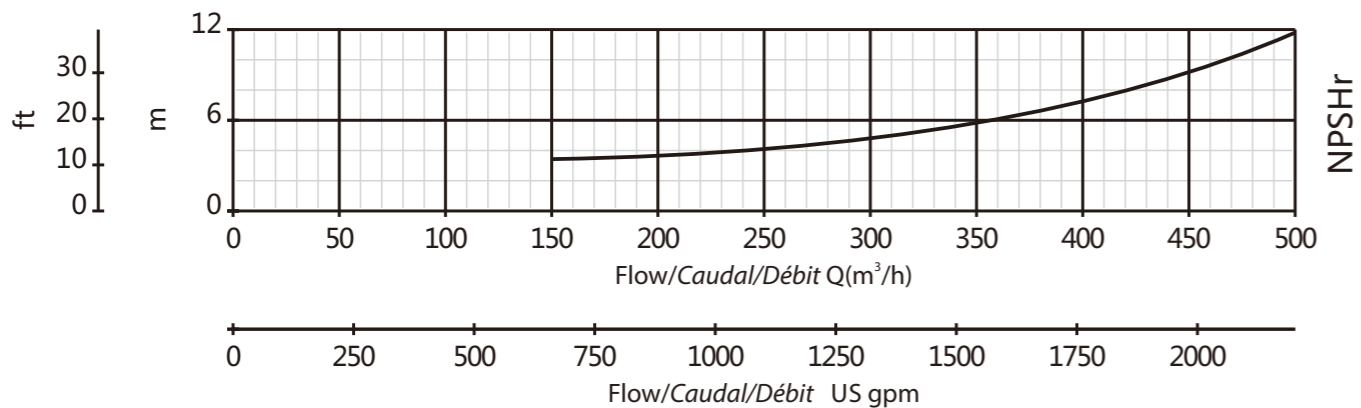
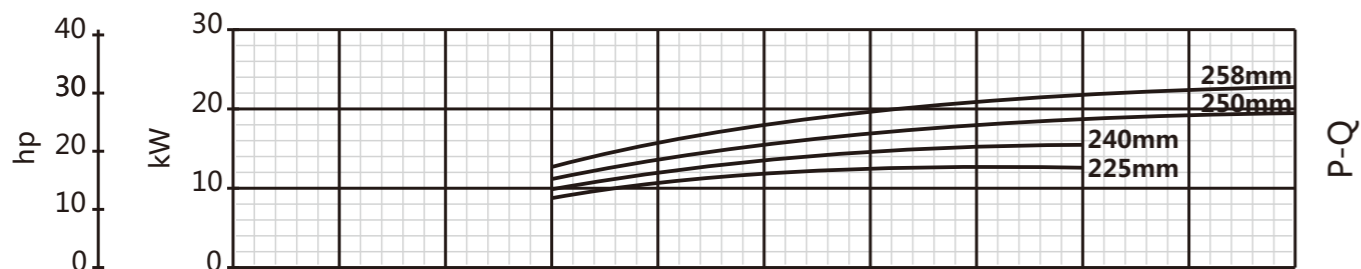
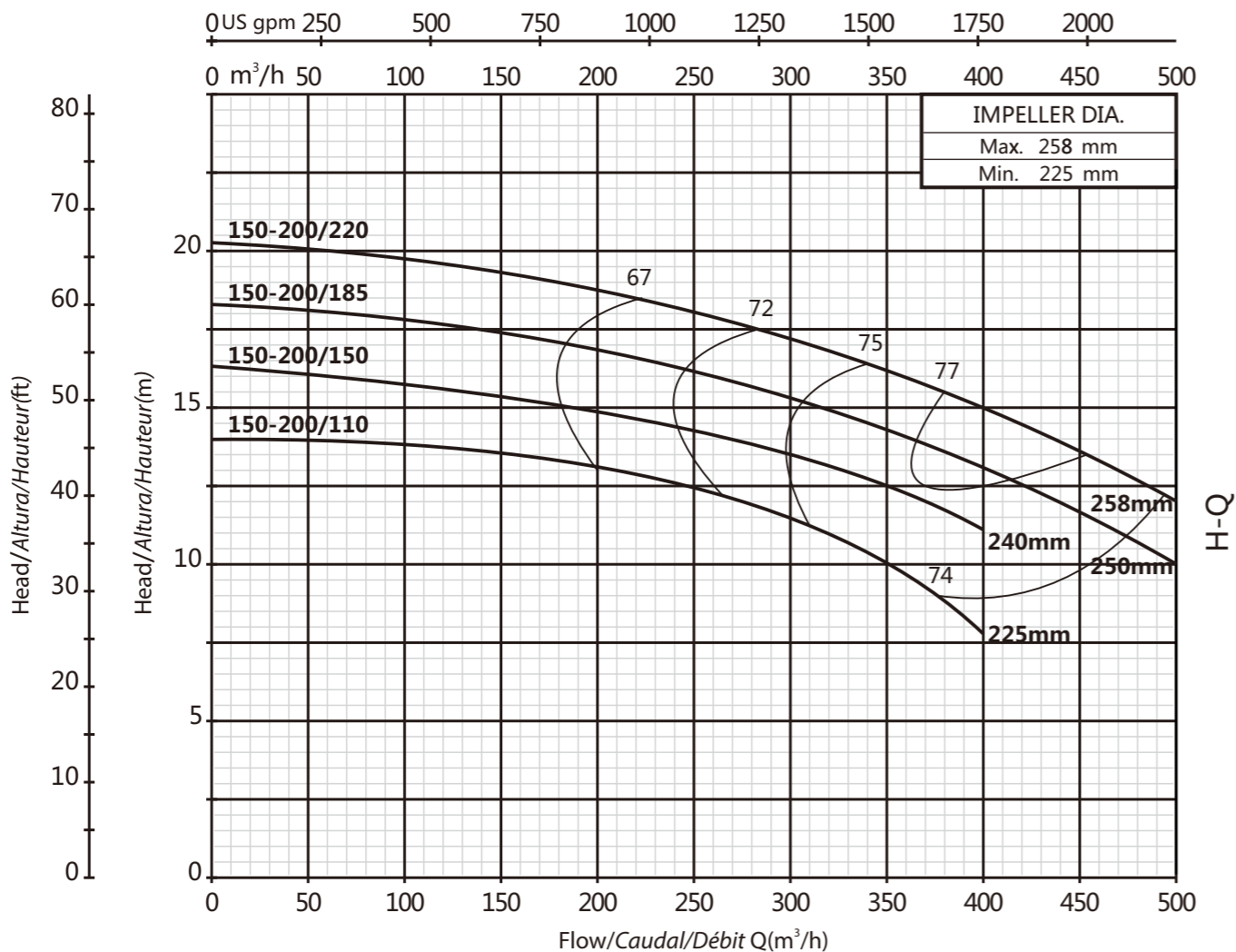

### 150-250

1450rpm

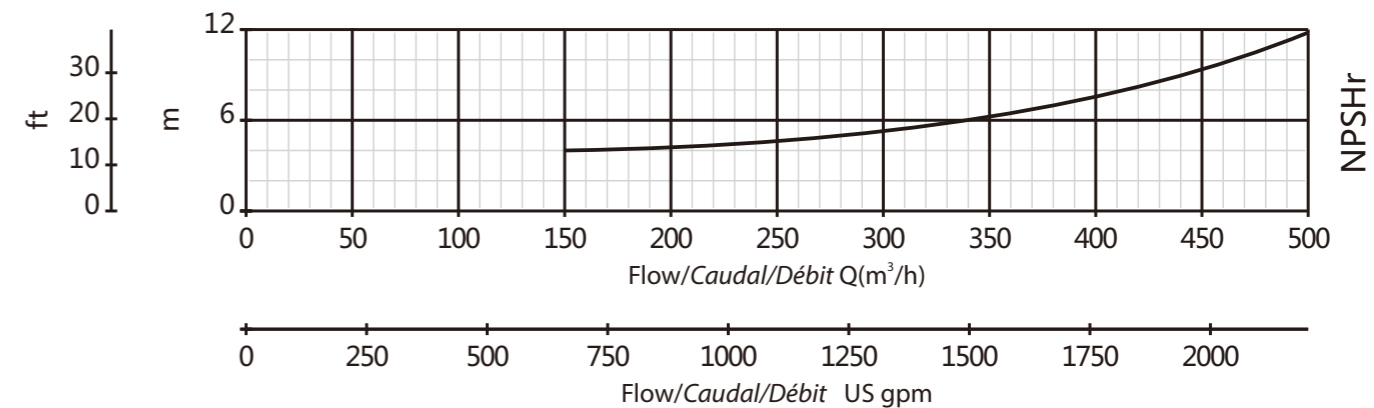
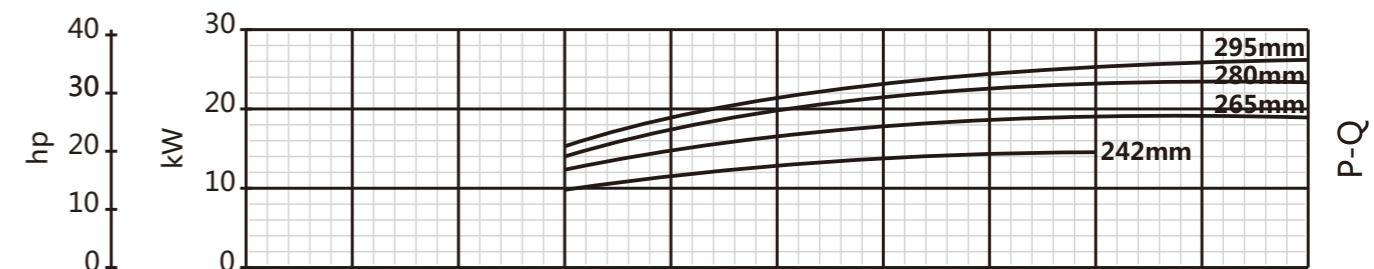
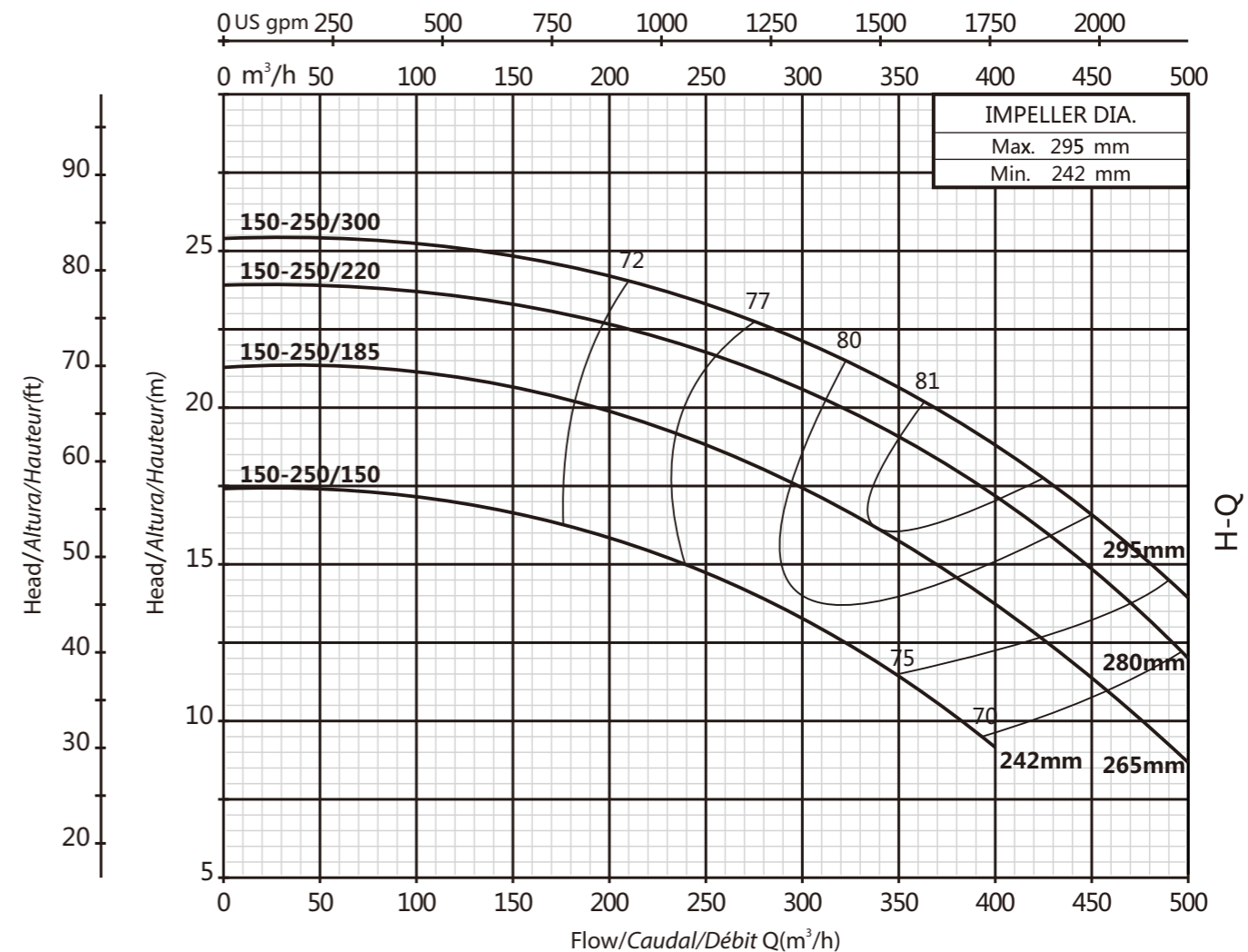

PERFORMANCE CURVE/CURVA DE RENDIMIENTO/COURBE DE PERFORMANCE

PERFORMANCE CURVE/CURVA DE RENDIMIENTO/COURBE DE PERFORMANCE

### 150-315

1450rpm

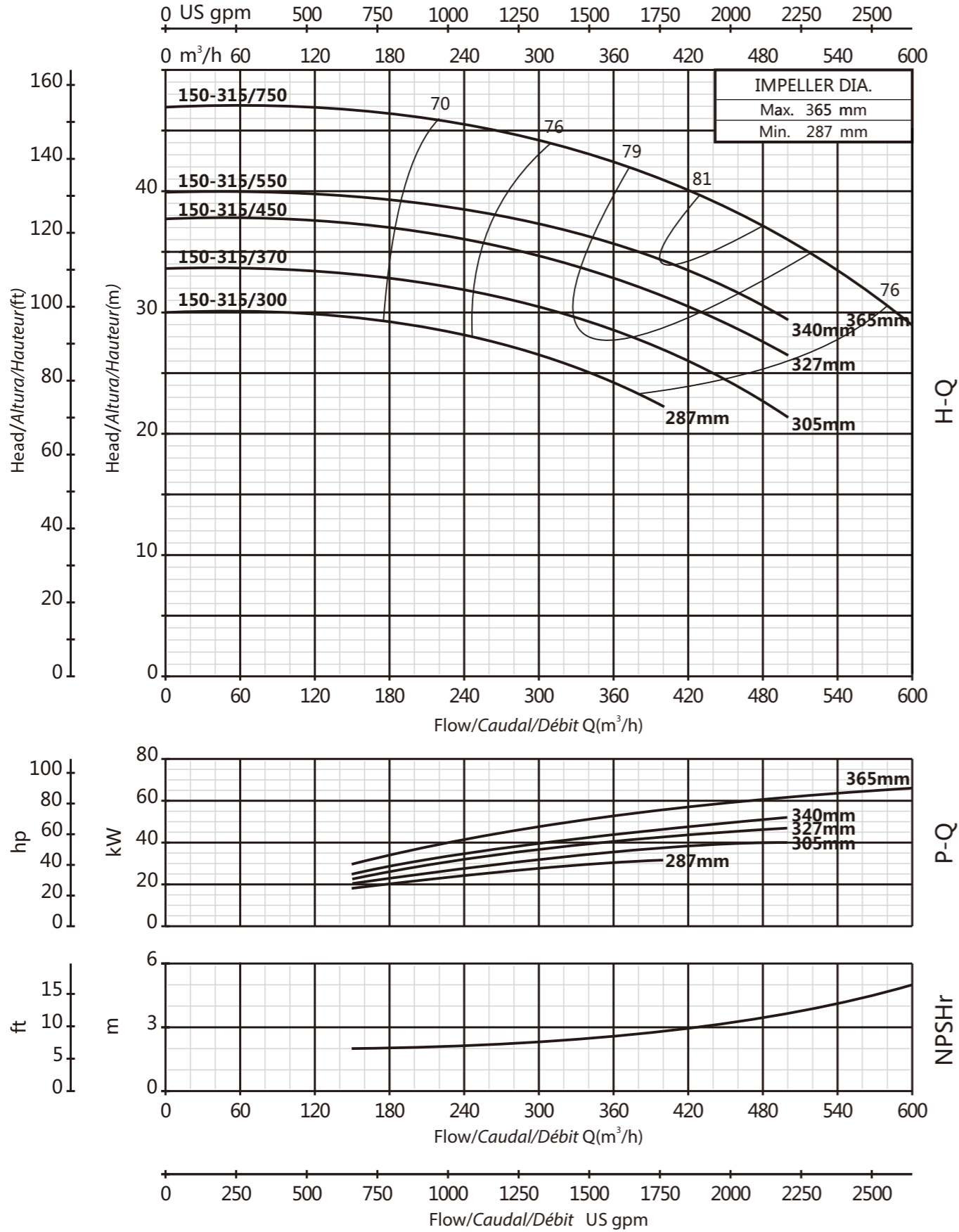

### 150-400

1450rpm

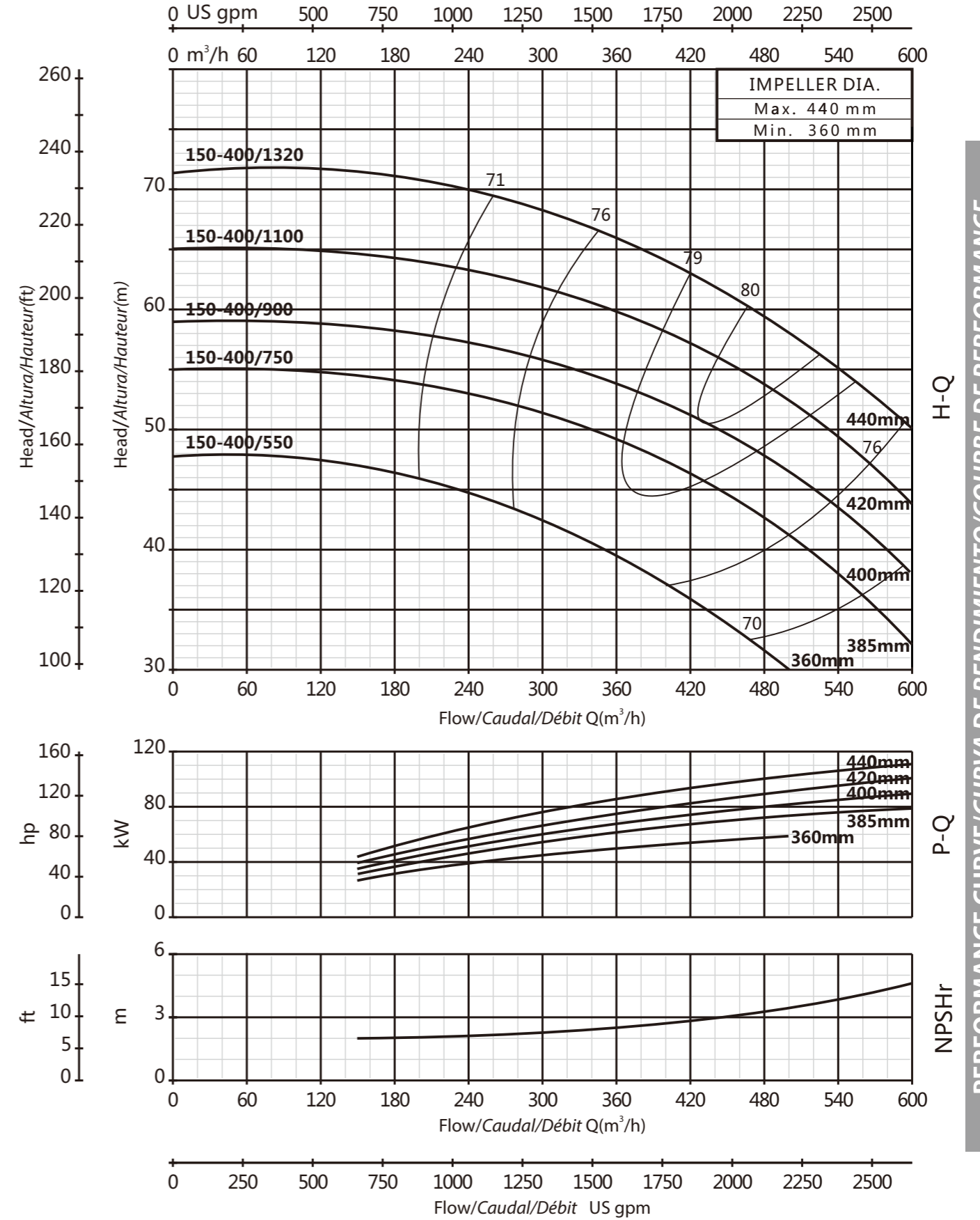

PERFORMANCE CURVE/CURVA DE RENDIMIENTO/COURBE DE PERFORMANCE

PERFORMANCE CURVE/CURVA DE RENDIMIENTO/COURBE DE PERFORMANCE