

BOXER 150

<https://prom-nasos.pro>

<https://bts.net.ua>

<https://prom-nasos.com.ua>

+38 095 656-37-57,

+38 067 360-71-01,

+38 063 362-12-31,

info@prom-nasos.pro

AIR-OPERATED DOUBLE DIAPHRAGM PUMPS

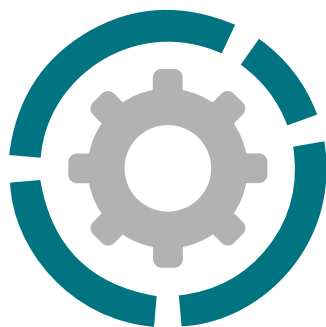

Suction / delivery connections	1"1/4 f BSPP (*)
Air fitting	1/2" f BSPP
Max flow rate*	220 l/min
Max supply air pressure	8 bar
Max head*	80 m
Max negative suction head - dry running**	4 m
Max negative suction head - pump primed	9,5 m
Max diameter suspended solids	5 mm
Noise level	75 dB
Volume per stroke	340 cc



[*] NPT fittings only on request

* The curves and performances refer to pumps with immersed suction and open delivery outlet with water at 20 °C and vary according to the composition materials.

** Value depends on pump configuration.

CE



- Product designed and constructed in Italy
- PATENTED stall-prevention pneumatic circuit
- Operates with NON-lubricated air
- SELF-PRIMING
- Supports dry running
- ATEX certification for ZONE 1 - ZONE 2
- IECEx certification
- Adjustable operating speed
- Versatile
- Suitable for pumping fluids with high viscosity and for demanding applications
- Usable with fluids containing suspended solids
- Option of suspended installation
- Manifolds available with stainless steel reinforcement rings for PP - PP + CF - PVDF pumps
- Suitable for continuous use

BOXER 150

AIR-OPERATED DOUBLE DIAPHRAGM PUMPS



Specifications and types



ATEX Zona 1 (CONDUCT): II2GExhIIIBT4Gb – II2DExhIIIBT135°CDbX
 ATEX Zona 2 (STANDARD): II3GExhIIIBT4Gc – II3DExhIIIBT135°CDeX – IM2ExhIMbX*
 IECEx: ExhIIIBT4Gb – ExhIIIBT135°CDb

* The string relating to mining applications is not applicable to aluminium BOXER range pumps



PP

Boxer 150



Maximum Dimensions

Height	386 mm
Width	399 mm
Depth	220 mm



Construction materials (body and manifolds) and net weight

Polypropylene (with glass filler)	12 Kg
Temp. 3°C min.	65°C max
Conductive polypropylene (with carbon filler)	12 Kg
Temp. 3°C min.	65°C max



PVDF

Boxer 150



Maximum Dimensions

Height	386 mm
Width	399 mm
Depth	220 mm



Construction materials (body and manifolds) and net weight

PVDF (with carbon filler)	14 Kg
Temp. 3°C min.	95°C max

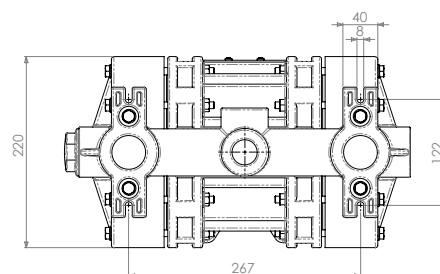
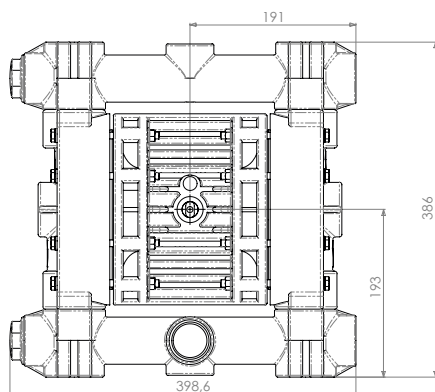
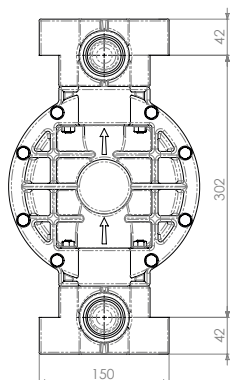

BOXER 150

AIR-OPERATED DOUBLE DIAPHRAGM PUMPS



Specifications and types



ATEX Zona 1 (CONDUCT): II2GExhIIIBT4Gb – II2DExhIIIBT135°CDbX
 ATEX Zona 2 (STANDARD): II3GExhIIIBT4Gc – II3DExhIIIBT135°CDeX – IM2ExhIMbX*
 IECEX: ExhIIIBT4Gb – ExhIIIBT135°CDb

* The string relating to mining applications is not applicable to aluminium BOXER range pumps



ALU

Boxer 150



Maximum Dimensions

Height	385 mm
Width	394 mm
Depth	220 mm



Construction materials (body and manifolds) and net weight

ALU	15 Kg Temp. 3°C min. 95°C max
-----	-------------------------------------

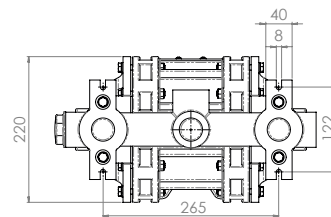
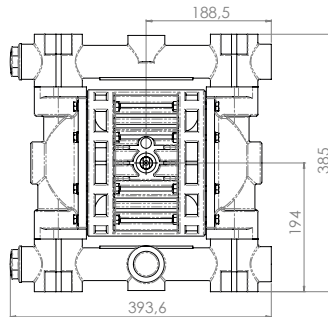
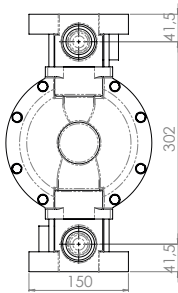

AISI 316

Boxer 150



Maximum Dimensions

Height	390 mm
Width	388 mm
Depth	220 mm



Construction materials (body and manifolds) and net weight

AISI 316	23 Kg Temp. 3°C min. 95°C max
----------	-------------------------------------

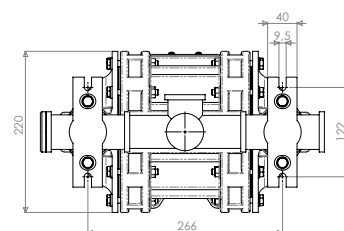
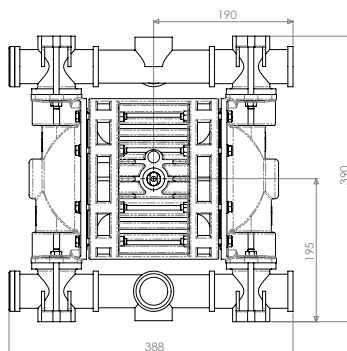
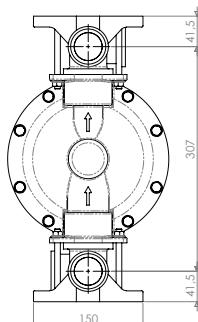

BOXER 150

AIR-OPERATED DOUBLE DIAPHRAGM PUMPS



Specifications and types



ATEX Zona 1 (CONDUCT): II2GExhIIIBT4Gb - II2DExhIIIBT135°CDBX
 ATEX Zona 2 (STANDARD): II3GExhIIIBT4Gc - II3DExhIIIBT135°CDCX - IM2ExhIMbX*
 IECEx: ExhIIIBT4Gb - ExhIIIBT135°CDB

* The string relating to mining applications is not applicable to aluminium BOXER range pumps

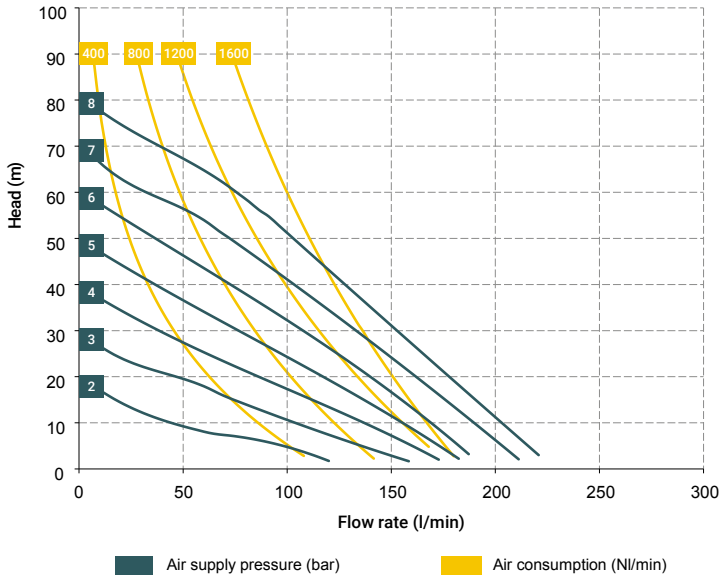

* The curves and performances refer to pumps with immersed suction and open delivery outlet with water at 20 °C and vary according to the composition materials.

Accessories:

- Equaflex 200
 (For damper materials, please refer to the technical data sheet)
- Truck model 01
- Foot valve
- Air regulation kit W3000-10-G
- Batch controller
- Stroke counter
- Flange kit (DIN flanges - ANSI on request)

Distributor material T30 ((compressed air circuit)

- POM

Core material:

- Polypropylene (with glass filler)
- Conductive polypropylene (with carbon filler)
- Aluminium
- AISI 316

Diaphragm materials:

- PTFE
- HYTREL®
- SANTOPRENE
- NBR
- EPDM

Ball materials:

- Polypropylene (with glass filler)
- Conductive polypropylene (with carbon filler)
- PVDF
- Aluminium
- AISI 316 L

O-ring materials:

- PTFE
- AISI 316 L
- EPDM
- NBR

O-ring materials:

- EPDM
- NBR
- VITON®
- PTFE

Packaging:

cardboard box - 29 x 48 x 47 cm - weight 2 kg
 (the weight refers only to the packaging without the pump inside)

Any colour variations in our polypropylene and PVDF products are due to the special blends of the raw materials used. The use of high levels of glass and long-fiber carbon filler result in a unique colour that does not in any way affect the quality of the product; on the contrary, it points to the high level of content used to ensure outstanding performance.

BOXER 150 (PP):

- A1 - A2 - A3 - A4 - A5 - A6
- M1 - M2 - M3 - M4 - M5 - M6

BOXER 150 (PVDF):

- A1 - A2 - A3 - A4 - A5 - A6
- M1 - M2 - M3 - M4 - M5 - M6

BOXER 150 (ALU):

- A1 - A2 - A3 - A4 - A5 - A6
- M1 - M2 - M3 - M4 - M5 - M6



BOXER 150 (INOX):

- A1 - A2 - A3
- M1 - M2 - M3

Standard fittings:

- Suction: A1
- Delivery: M1



Standard fittings:

- Suction: A1
- Delivery: M1

BOXER 150

AIR-OPERATED DOUBLE DIAPHRAGM PUMPS



Specifications and types



ATEX Zona 1 (CONDUCT): II2GExhIIIBT4Gb – II2DExhIIIBT135°CDbX
 ATEX Zona 2 (STANDARD): II3GExhIIIBT4Gc – II3DExhIIIBT135°CDcX – IM2ExhIMbX*
 IECEx: ExhIIIBT4Gb – ExhIIIBT135°CDb

* The string relating to mining applications is not applicable to aluminium BOXER range pumps

BOXER PUMPS CODES ENCODING

ex. IB150-P-HTTPV--

Internal distributor, Boxer 150, body PP, air-side diaph. Hytrel®, product-side diaph. PTFE, AISI 316 L balls, PP ball seats, EPDM O-Ring.

IB150- PUMP MODEL	P PUMP BODY	H AIR-SIDE DIAPHRAGM	T FLUID-SIDE DIAPHRAGM	T BALLS	P BALL SEATS	V O-RING	- MANIFOLD	- VERSION
IB07 - Boxer 07 IB15 - Boxer 15 IMICR - Microboxer IB35 - Boxer 35 IB50 - Boxer 50 IMIN - Miniboxer IB81 - Boxer 81 IB90 - Boxer 90 IB100 - Boxer 100 IB150 - Boxer 150 IB251 - Boxer 251 IB252 - Boxer 252 IB522 - Boxer 522 IB502 - Boxer 502 IB503 - Boxer 503	P - PP PC - PP+CF FC - PVDF+CF A - AISI 316 (L) AL - ALU	N - NBR D - EPDM H - Hytrel® M - Santoprene®	T - PTFE	T - PTFE A - AISI 316 L D - EPDM N - NBR	P - Polypropylene F - PVDF A - AISI 316 L I - PE-UHMW R - PPS L - Aluminium	D - EPDM V - Viton® N - NBR T - PTFE	X* 3* Y* W* K*	C* Z*

Example table, for the table with the complete codes please contact the Debem sales department.

*X = split manifold
 *3 = 3rd hole on the manifold
 *Y = manifold with NPT fitting
 *W = clamp manifold
 *K = manifold with reinforcement rings
 (all on request only)

C = CONDUCT version for ATEX ZONE 1
 Z = Version for IECEx Standard

SELF-PRIMING USE



UNDER HEAD USE



IMMERSED



DRUM TRANSFER



SPLIT SUCTION and DELIVERY



MAIN APPLICATION SECTORS



MAIN APPLICATION SECTORS

- AUTOMOTIVE
- PRODUCTION AND STORAGE OF BIODIESEL
- WATER AND SLUDGE TREATMENT
- CHEMICAL INDUSTRY
- OIL & GAS
- GRAPHIC INDUSTRY
- CERAMIC, STONE, MARBLE GLASS AND MINING INDUSTRY
- PAINT INDUSTRY
- GOLD PROCESSING INDUSTRY
- PACKING, GLUE, PAPER AND PAPER MILLS
- TEXTILE AND LEATHER INDUSTRY
- MECHANICAL AND METALLURGICAL INDUSTRY
- GALVANIC AND ELECTRONIC INDUSTRY